

índice index sommaire indice

INTRODUCCIÓN INTRODUCTION INTRODUCTION INTRODUZIONE		Pag. 02
PISCINAS ENTERRADAS IN-GROUND POOLS PISCINE ENTERRÉ PISCINE INTERRATA		Pag. 06
PISCINAS DE MADERA WOODEN POOL PISCINE BOIS PISCINA IN LEGNO		Pag. 14
PISCINAS DE COMPOSITE COMPOSITE POOLS PISCINES COMPOSITE PISCINA IN COMPOSITE		Pag. 26
PISCINAS HIBRIDAS HYBRIDS POOLS PISCINES HYBRIDE PISCINE IBRIDE		Pag. 32
PISCINAS DE ACERO STEEL WALL POOLS PISCINES PAROI ACIER PISCINA IN ACCIAIO		Pag. 36
COMPLEMENTOS COMPLEMENTES COMPLEMENTS COMPLEMENTI		Pag. 74
MATERIAL DE LIMPIEZA CLEANING MATERIAL MATÉRIEL DE NETTOYAGE MATERIALE DI PULIZIA		Pag. 120
PRODUCTO QUÍMICO CHEMICALS PRODUITS D'ENTRETIEN CHIMICI		Pag. 155



PISCINAS POOLS PISCINES PISCINAS
COMPOSITE



MADERA WOODEN BOIS LEGNO

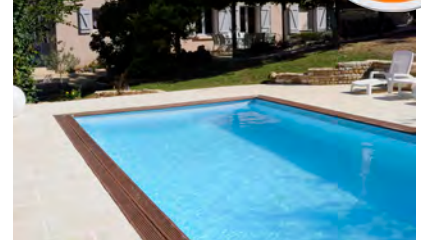

PISCINAS ACERO NEW DESIGN NOUVEAU DESIGN NUOVO DESIGN



GAMA CONFORT CONFORT RANGE
GAMME CONFORT GAMMA CONFORT



CUBIERTAS ISOTÉRMICAS PARA PISCINAS ENTERRADAS

IN-GROUND POOLS ISOTHERMIC COVERS
BÂCHES ÉTÉ POUR PISCINES ENTÉRÉE
COPERTURE ISOTHERMICHIE PER PISCINE INTERRATA

FILTRO AQUALOON
AQUALOON FILTER
AQUALOON FILTRE
AQUALOON FILTRO



LINERS PARA PISCINA DE MADERA
WOODEN POOL LINERS
FONDS POUR PISCINES BOIS
LINERS PER PISCINE IN LEGNO

MEDIO FILTRANTE
FILTER MEDIA
MOYEN FILTRATION
SISTEMA FILTRANTE



ELASTIC SWIMMER
ELASTIC SWIMMER
ELASTIC SWIMMER
ELASTIC SWIMMER



PODS HIDROSOLUBLES WATER SOLUBLE PODS
HYDROSOLUBLE PODS PODS IDROSOLUBILE



QUÍMICO 3L-3Kg
3L-3Kg CHEMICALS
CHIMIQUES 3L-3Kg
PRODOTTI CHIMICI 3L-3Kg



DUCHA SOLAR
SOLAR SHOWER
DOUCHE SOLAIRE
DOCCIA SOLARE

CALEFACCIÓN HEATING SYSTEMS
CHAUFFAGE RISCALDAMENTO



LIMPIAFONDOS ELÉCTRICOS ELECTRIC CLEANERS
NETTOYEUR DE FOND ÉLECTRIQUE
PULITORE ELETTRICO PER FONDO PISCINA



LIMPIAFONDOS AUTOMÁTICO
AUTOMATIC CLEANERS
NETTOYEUR DE FOND AUTOMATICO
PULITORE AUTOMATICO





Presentación de la empresa

Gre es una empresa con más de 50 años de experiencia en la fabricación de piscinas elevadas.

Como empresa pionera en el sector, somos especialistas y líderes a nivel europeo.

Nuestra apuesta clara por la calidad y seguridad de todos nuestros productos, nos convierte en la referencia fundamental del mercado.

Nuestra empresa ofrece una amplia gama de productos: piscinas elevadas de diferentes formatos y acabados, una completa línea de accesorios para su equipamiento y mantenimiento y una serie de productos químicos diseñados específicamente para el agua de la piscina.

Con el ánimo siempre, de satisfacer al cliente, Gre ha diseñado una estrategia de servicios, cuyo objetivo es ofrecer una solución integral. Nuestra amplia red de Servicios Técnicos, así como nuestros Departamentos de Atención al Cliente, son la mejor prueba de ello. Estos servicios nos permiten asesorarle sobre la opción de piscina y equipamiento más adecuados a sus necesidades.

Présentation de l'entreprise

Gré est une société spécialisée dans la fabrication de piscines hors-sol.

Pionnière dans le secteur, notre entreprise est SPÉCIALISTE et LEADER en EUROPE.

Notre pari sur la QUALITÉ et la SÉCURITÉ de tous nos produits nous permet d'être la principale RÉFÉRENCE du marché.

Notre entreprise offre une LARGE GAMME de produits, allant des piscines hors-sol aux tailles et finitions diverses et variées, jusqu'à un éventail complet des accessoires nécessaires à l'équipement et à l'entretien, et une gamme de produits chimiques conçus spécifiquement pour l'eau de la piscine.

Toujours dans le but de satisfaire le client, Gre a conçu une stratégie de SERVICES dont l'objectif est d'offrir une réponse et une solution complètes: un important réseau de Services Techniques ainsi qu'un Service Clients. Ces services nous permettent de vous conseiller sur le choix tant de votre piscine que de l'équipement le plus approprié à vos besoins.

Company presentation

Gre is a company with more than 50 years experience in manufacturing above-ground pools.

As a pioneer company on its field, we are SPECIALISTS and LEADERS within the European market.

We are considered to be a fundamental market REFERENCE as a result of our clear wager on QUALITY and SECURITY of all our products.

Our company offers a WIDE RANGE of products which includes: different sizes and finishes aboveground pools, a complete range of accessories for their equipment and maintenance and a number of swimming pool chemicals designed specifically for the pool water.

Bearing in mind our customers satisfaction, Gre has designed an important SERVICES strategy whose aim is to offer an integral solution. Our wide network of Technical Services and our Customer Service Departments are the best proof of that. These services help us to identify our customers needs and to advice them on the best pool and equipment according to those needs.

Presentazione dell'azienda

La Gre è un'azienda con oltre 50 anni di esperienza nella produzione di piscine smontabili su terra.

Come impresa pioniera nel settore, siamo SPECIALISTI e LEADER a livello EUROPEO.

La nostra chiara scommessa sulla QUALITÀ e sulla SICUREZZA di tutti i nostri prodotti, fa di noi il RIFERIMENTO fondamentale del mercato.

La nostra società offre una VASTA GAMMA di prodotti: piscine elevate di diversi formati e rifiniture, una completa linea di accessori per l'attrezzatura e la manutenzione e una serie di prodotti chimici pensati specificamente per l'acqua della piscina.

Sempre con l'intenzione di soddisfare il cliente, la Gre ha progettato una strategia di SERVIZI il cui scopo è quello di offrire una soluzione integrale. La nostra vasta rete di Servizi Tecnici, così come i nostri Reparti di Servizio al Cliente, ne sono la miglior prova. Tali servizi ci consentono di dare consulenza sulla scelta della piscina e dell'equipaggiamento più idoneo alle vostre necessità.

Certificaciones Certifications Certifications Certificazioni

MADE IN EUROPE

Todas las piscinas fabricadas por Manufacturas GRE S.A. Son de origen CE - Comunidad Europea.

Toutes les piscines fabriquées par Manufacturas Gre S.A. sont d'Origine CE - Communauté Européenne.

All the pools manufactured by Manufacturas Gre S.A. are of EC - European Community origin.

Tutte le piscine prodotte da Manufacturas Gre S.A. sono di origine CE - Comunità Europea.



ISO 9001

Los procesos utilizados para el diseño, la fabricación y comercialización de piscinas desmontables de Manufacturas Gre S.A., así como la comercialización de productos asociados, están certificados siguiendo los criterios de sistema de Gestión de Calidad según la norma internacional ISO9001:2015, lo cual garantiza regularidad y control en la calidad de nuestros productos y procesos.

Les processus utilisés pour la conception, la fabrication et la commercialisation de piscines hors-sol de Manufacturas Gre S.A., ainsi que la commercialisation de produits associés, sont certifiés conformes aux critères de système de Gestion de Qualité selon la norme internationale ISO9001:2015.

The processes used for the design, manufacturing and commercialisation of dismountable pools by Manufacturas Gre S.A., as well as the commercialisation of associated products, are certified according to the Quality System according to the international ISO9001:2015 standard, which guarantees regularity and control in the quality of our products and processes.

I processi utilizzati per la progettazione, la costruzione e la vendita di piscine smontabili a marchio Manufacturas Gre S.A., oltre alla vendita di prodotti ad esse associati, sono certificati in base ai criteri del sistema di Gestione della Qualità secondo la norma internazionale ISO9001:2015, ciò garantisce la regolarità e il controllo della qualità dei nostri prodotti e dei processi produttivi.



ISO 14001

Gracias a la implantación de un Sistema de Gestión Ambiental según la norma internacional ISO 14001: 2015, Manufacturas Gre S.A. se posiciona como una empresa socialmente responsable. Entre otras ventajas ambientales, optimizamos la gestión de recursos y residuos, reduciendo los impactos ambientales negativos derivados de nuestra actividad o aquellos riesgos asociados a situaciones accidentales.

Grâce à l'implémentation d'un Système de Gestion Environnementale conformément à la norme internationale ISO 14001:2015, Manufacturas Gre S.A. se positionne comme une entreprise socialement responsable. Parmi de nombreux avantages environnementaux, nous optimisons la gestion des ressources et des déchets, réduisant ainsi les impacts environnementaux négatifs et dérivés de notre activité ou les risques associés à des situations d'accidents.

Thanks to the implantation of an Environmental Management System according to the international ISO 14001:2015 standard, Manufacturas Gre S.A. is positioned as a socially responsible company. Among other environmental advantages, we optimise resources and residues, reducing negative environmental impact derived from our activity or those risks associated to accidental situations.

Grazie all'introduzione di un Sistema di Gestione Ambientale secondo la norma internazionale ISO 14001:2015, Manufacturas Gre S.A. si classifica tra le aziende socialmente responsabili. Ciò comporta vantaggi per l'ambiente come l'ottimizzazione della gestione delle risorse, la riduzione degli impatti ambientali negativi derivanti dall'attività di produzione o dei rischi associati a eventi accidentali.



ARBITRAJE DE CONSUMO / CONSUMER ARBITRATION / ARBITRAGE DE CONSOMMATION / ARBITRATO DI CONSUMO

Manufacturas Gre S.A. está adherido a la Junta Arbitral de Consumo como muestra de predisposición a la solución amistosa de cualquier tipo de reclamación por parte de sus clientes.

Manufacturas Gre S.A. est membre du bureau d'Arbitrage de Consommation, comme preuve de prédisposition à la solution amiable de tout type de réclamation de la part de ses clients.

Manufacturas Gre S.A. is adhered to the Consumer Arbitration Directorate evidencing predisposition to a friendly solution to any type of reclamation from its clients.

Manufacturas Gre S.A. aderisce alla Giunta Arbitrale di Consumo come segnale di predisposizione alla soluzione amichevole di qualsiasi tipo di reclamo da parte dei propri clienti.



CE

Los productos distribuidos por Manufacturas Gre S.A. con el marcado CE cumplen todos los requisitos legales vigentes en Europa.

Les produits distribués par Manufacturas Gre S.A. dotés du marquage CE répondent à toutes les obligations légales en vigueur en Europe.

The products distributed by Manufacturas Gre S.A., with the CE marking comply with all the legal requirements in force in Europe.

I prodotti distribuiti da Manufacturas Gre S.A. con il marchio CE rispettano tutti i requisiti legali vigenti in Europa.





NF P 90 - 303, NF P 90 - 318, NF P 90 - 319, EN16582-1: 2015, EN16582-3: 2015

Estas certificaciones garantizan que las piscinas, filtros y escaleras fabricados y/o distribuidos por Manufacturas Gre S.A. cumplen con las normativas de seguridad establecidas.

These certifications guarantee that the pools, filters and stepladders manufactured and/or commercialised by Manufacturas Gre S.A. comply with the established safety regulations.

Ces certifications garantissent que les piscines, les filtres et les échelles fabriqués et/ou distribués par Manufacturas Gre S.A. respectent les normes de sécurité établies.

Queste certificazioni garantiscono che le piscine, i filtri e le scalette prodotti e/o distribuiti da Manufacturas Gre S.A. rispettano le normative di sicurezza previste.

ECOEMBES



Manufacturas Gre S.A. está adherida a un sistema de recogida y reciclaje selectivo de los materiales que pone en el mercado con el fin último de preservar el medio ambiente.

Manufacturas Gre S.A. is adhered to a system for the selective collection and recycling of the materials it puts on the market in order to conserve the environment.

Manufacturas Gre S.A. est membre d'un système de collecte et de recyclage sélectif des matériaux qu'elle met sur le marché, dans le but de préserver l'environnement.

Manufacturas Gre S.A. aderisce a un sistema di raccolta differenziata e riciclaggio dei materiali immessi sul mercato, in un'ottica di preservazione dell'ambiente.

REACH



Manufacturas Gre S.A. cumple con el reglamento Reach asegurando que todas las sustancias químicas que comercializa están registradas.

Manufacturas Gre S.A. complies with the Reach regulation ensuring that all the chemical substances it commercialises are registered.

Manufacturas Gre S.A. respecte le règlement Reach, qui garantit que toutes les substances chimiques qu'elle commercialise sont enregistrées.

Manufacturas Gre S.A. rispetta il regolamento Reach garantendo la registrazione di tutte le sostanze chimiche immesse sul mercato dall'azienda.

ROHS



Manufacturas Gre S.A. cumple esta directiva para proteger el medio ambiente y la salud de las personas, evitando el uso de determinadas sustancias en aparatos eléctricos y electrónicos.

Manufacturas Gre S.A. complies with this directive to protect the environment and health of persons, avoiding the use of determined substances in electrical and electronic devices.

Manufacturas Gre S.A. respecte cette directive afin de protéger l'environnement et la santé des personnes, évitant ainsi l'utilisation de substances déterminées dans les appareils électriques et électroniques.

Manufacturas Gre S.A. rispetta questa normativa per proteggere l'ambiente e la salute delle persone, evitando l'utilizzo di determinate sostanze su dispositivi elettrici ed elettronici.

PEFC



Manufacturas Gre S.A. cumple con los requisitos del Estándar de Cadena de Custodia de Productos Forestales PEFC ST 2002:2013.

Manufacturas Gre S.A. complies with the requirements of the Programme for the Endorsement of Forest Certification PEFC ST 2002:2013.

Manufacturas Gre S.A. respecte les conditions du Standard de la Chaîne de Contrôle de Produits Forestiers PEFC ST 2002:2013.

Manufacturas Gre S.A. rispetta i requisiti previsti dallo Standard della catena di custodia dei prodotti forestali PEFC ST 2002:2013.

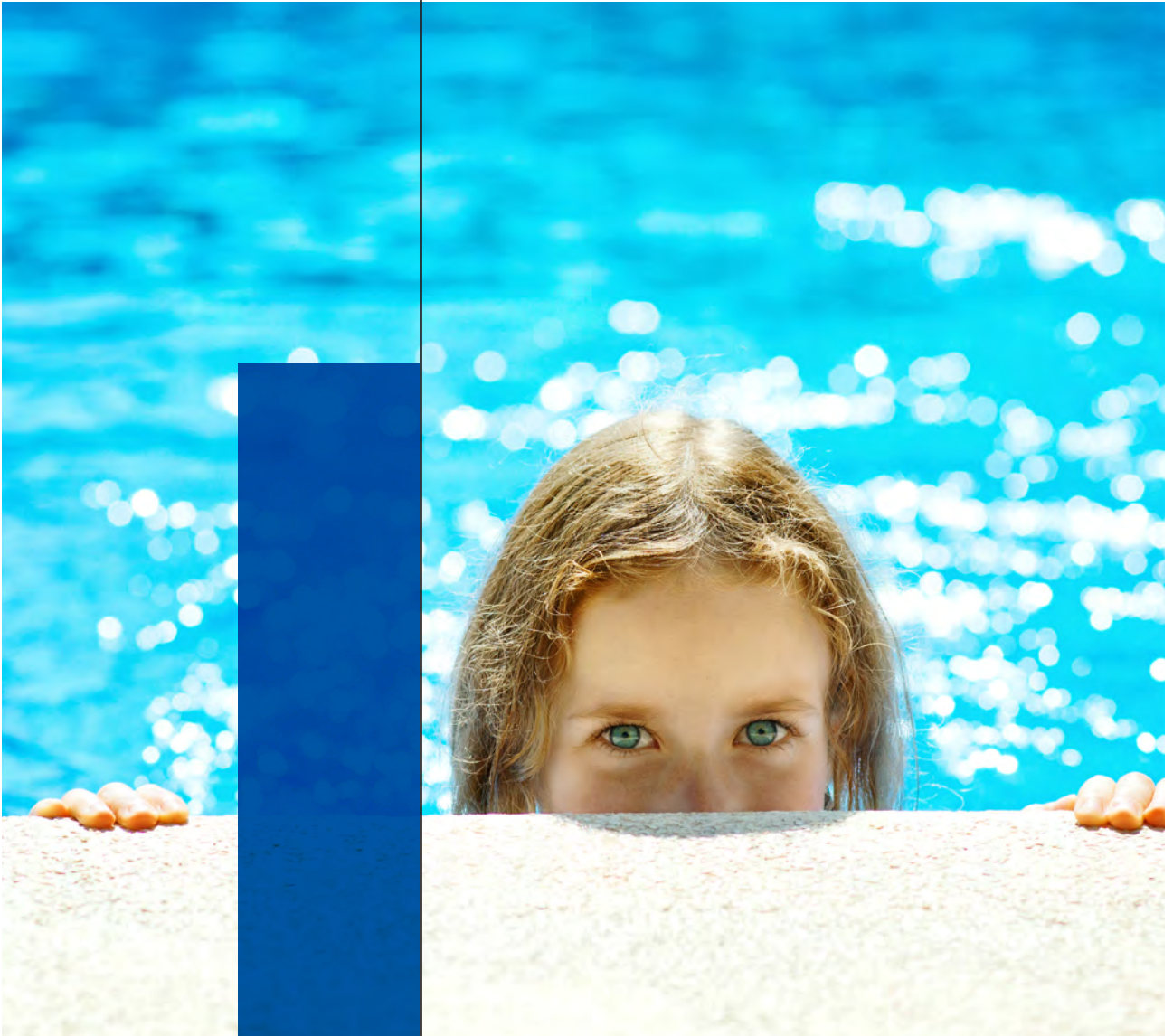

PISCINA ENTERRADA DE PARED DE ACERO

LINER: Tratamiento Anti-ultravioleta que retrasa el envejecimiento del P.V.C.

CHAPA: Laminada en frío con tratamiento de galvanización, fosfatación e imprimación.

Troquelada para skimmer, válvulas de retorno y limpiafondos y focos.

PISCINE ENTÉRÉE PAROI ACIER

LINER: Traitement anti-ultraviolets contre le vieillissement du P.V.C.

TÔLE: Tôle laminée à froid et traitée par galvanisation, phosphatage, couche d'apprêt et laquage.

Découpage pour le skimmer, la buse de refoulement et la prise balai. Prédécoupe pour les projecteurs.

IN-GROUND STEEL WALL POOL

LINER: Anti-ultraviolet treatment to slow down P.V.C aging.

PLATE: Galvanized, phosphatized, primed and lacquered cold-rolled plate.

Die cut for skimmer, return valve and cleaner openings and lights.

PISCINE INTERRATA CON PARETI IN ACCIAIO

LINER: Trattamento Anti-ultravioletti - Ritarda l'invecchiamento del P.V.C.

PANNELLO: Laminata a freddo con trattamento di galvanizzazione, fosfatazione e preparazione.

Stampigliatura per Skimmer, valvola di ritorno e puliscifondi e spot.



**MADE
IN
EU**

in-ground pool

serie

MOOREA



EAN 13

	800x400 cm	700x320 cm	600x320 cm	500x300 cm	150 cm	38.840 l	27.470 l	24.420 l	16.015 l	217/232 kg	189/232 kg	164/232 kg	139/232 kg	1/120x80 1/90x80	1/120x80 1/90x80	1/120x80 1/90x80	1/120x80 1/90x80	10m³/h	10m³/h	10m³/h	10m³/h	√	√	√	√	8 4 1 2 0 8 1 2 6 9 5 9 7	8 4 1 2 0 8 1 2 6 9 6 0 3	8 4 1 2 0 8 1 2 6 9 6 1 0	8 4 1 2 0 8 1 2 6 9 6 2 7	
KPEOV8059M																														
KPEOV7059M																														
KPEOV6059M																														
KPEOV5059M																														



MEDIDA PISCINA
POOL SIZE
DIMENSIONS PISCINE
MISURA PISCINA

ESPACIO NECESARIO
NECESSARY SPACE
ESPACE NECESSAIRE
SPAZIO NECESSARIO

KPEOV8059M	800x400x150 cm	1000x600x165 cm
KPEOV7059M	700x320x150 cm	900x520x165 cm
KPEOV6059M	600x320x150 cm	800x520x165 cm
KPEOV5059M	500x300x150 cm	700x500x165 cm



Liner PVC azul
75/100
PVC blue liner
75/100
Liner bleu PVC
75/100
Liner blu PVC
75/100

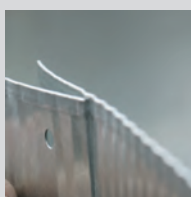

Chapa prelacada
70/100
Prelacquered steel
70/100
Tôle prélaquée
70/100
Lamiere laccata
70/100

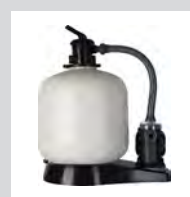

Depuradora arena
(Caudal grupo 10/8 m³/h)
Sand filter
(Flow group 10/8 m³/h)
Filtre à sable
(Débit groupe 10/8 m³/h)
Filtro a sabbia
(Portata gruppo 10/8 m³/h)



PLREB BXL PACK 1



Proyector LED BLANCO para piscina enterrada.
Projecteur LED BLANCHE pour piscine enterrée.

WHITE LED projector for in-ground pools.
Faretto LED BIANCO per piscina interrata.

PLREC BXL PACK 1



Proyector LED COLOR para piscina enterrada.
Con control remoto.
Projecteur LED de COULEUR pour piscine enterrée.
Avec télécommande.

COLOR LED projector for in-ground pools.
With remote control.
Faretto LED MULTICOLOR per piscina interrata.
Include telecomando.



EAN 13

KPE4259M

Ø420 cm

150 cm

18.840 l

126/232 kg

1/120x80
1/90x80

10m³/h

✓

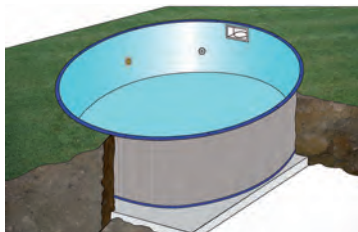

MEDIDA PISCINA
POOL SIZE
DIMENSIONS PISCINE
MISURA PISCINA

ESPACIO NECESARIO
NECESSARY SPACE
ESPACE NECESSAIRE
SPAZIO NECESSARIO

KPE4259M

Ø420x150 cm

Ø620x165 cm



Escalera fácil acceso:
3 peldaños - Inox.
Easy access ladder:
3 steps - Stainless steel
Echelle d'accès facile:
3 marches - Acier inoxydable
Scala di accesso facile:
3 gradini - Inox



Manta protectora
(Poliéster)
Bottom protectiveblanket
(Polyester)
Tapis de sol en feutre
(Polyester)
Telo di protezione
(Poliestere)



Skimmer, manguera,
racordería...
Skimmer, hose,
fittings...
Skimmer, tuyau,
raccords...
Skimmer, tubo,
racordería...

in-ground pool

serie

MADAGASCAR

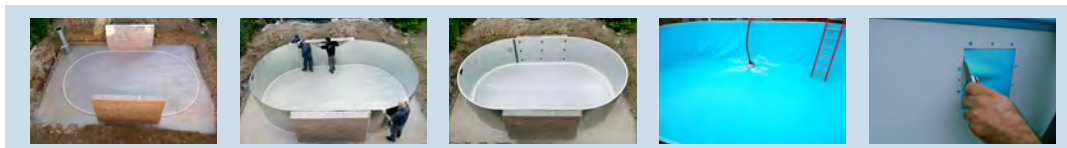

EAN 13

Model	Dimensions	Depth	Capacity	Weight	Box Size	Flow Rate	Features	EAN 13
KPEOV8059	800x400 cm	150 cm	38.840 l	217/224 kg	1/120x80 1/90x80	10m ³ /h	√	8 4 1 2 0 8 1 2 6 9 3 2 0
KPEOV7059	700x320 cm	150 cm	27.470 l	189/224 kg	1/120x80 1/90x80	10m ³ /h	√	8 4 1 2 0 8 1 2 6 9 3 3 7
KPEOV6059	600x320 cm	150 cm	24.420 l	164/224 kg	1/120x80 1/90x80	10m ³ /h	√	8 4 1 2 0 8 1 2 6 9 3 4 4
KPEOV5059	500x300 cm	150 cm	16.015 l	139/224 kg	1/120x80 1/90x80	10m ³ /h	√	8 4 1 2 0 8 1 2 5 8 9 0 4



MEDIDA PISCINA
POOL SIZE
DIMENSIONS PISCINE
MISURA PISCINA

ESPACIO NECESARIO
NECESSARY SPACE
ESPACE NECESSAIRE
SPAZIO NECESSARIO

Model	Pool Size	Necessary Space
KPEOV8059	800x400x150 cm	1000x600x165 cm
KPEOV7059	700x320x150 cm	900x520x165 cm
KPEOV6059	600x320x150 cm	800x520x165 cm
KPEOV5059	500x300x150 cm	700x500x165 cm



Liner PVC azul
75/100
PVC blue liner
75/100
Liner bleu PVC
75/100
Liner blu PVC
75/100

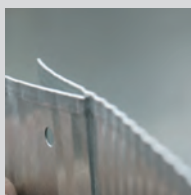

Chapa prelacada
70/100
Prelacqued steel
70/100
Tôle prélaquée
70/100
Lamiere laccata
70/100

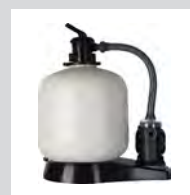

Depuradora arena
(Caudal grupo 10/8 m³/h)
Sand filter
(Flow group 10/8 m³/h)
Filtre à sable
(Débit groupe 10/8 m³/h)
Filtro a sabbia
(Portata gruppo 10/8 m³/h)



EAN 13

KPE4259

Ø420 cm

150 cm

18.840 l

126/224 kg

1/120x80
1/90x80

10m³/h

√

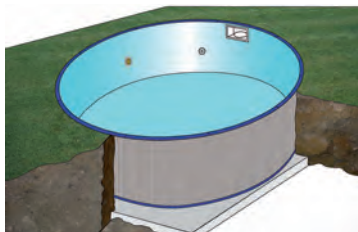

MEDIDA PISCINA
POOL SIZE
DIMENSIONS PISCINE
MISURA PISCINA

ESPACIO NECESARIO
NECESSARY SPACE
ESPACE NECESSAIRE
SPAZIO NECESSARIO

KPE4259

Ø420x150 cm

Ø620x165 cm



Escalera:
4 peldaños - Inox.
Ladder:
4 steps - Stainless steel
Échelle:
4 marches - Acier inoxydable
Scala:
4 gradini - Inox

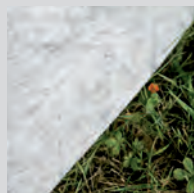

Manta protectora
(Poliéster)
Bottom protectiveblanket
(Polyester)
Tapis de sol en feutre
(Polyester)
Telo di protezione
(Poliestere)



Skimmer, manguera,
racordería...
Skimmer, hose,
fittings...
Skimmer, tuyau,
raccords...
Skimmer, tubo,
racordería...

in-ground pool

serie

SUMATRA

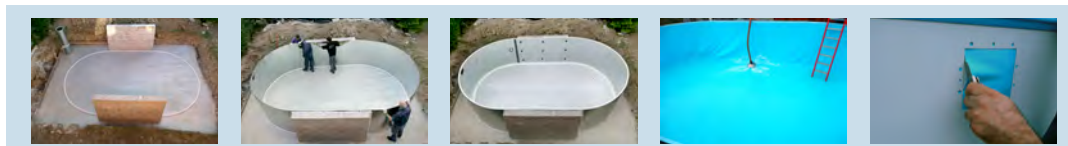

EAN 13

Model	Dimensions (cm)	Height (cm)	Capacity (l)	Weight (kg)	Box Dimensions (cm)	Flow Rate (m³/h)	✓	EAN 13
KPEOV8027	800x400	120	30.000	193/222	1/120x80 1/90x80	10	✓	8 4 120 8 1 2 6 9 3 6 8
KPEOV7027	700x320	120	21.210	173/222	1/120x80 1/90x80	10	✓	8 4 120 8 1 2 6 9 3 7 5
KPEOV6027	600x320	120	17.850	154/222	1/120x80 1/90x80	10	✓	8 4 120 8 1 2 6 9 3 8 2
KPEOV5027	500x300	120	12.360	154/222	1/120x80 1/90x80	10	✓	8 4 120 8 1 2 5 8 9 5 9



MEDIDA PISCINA
POOL SIZE
DIMENSIONS PISCINE
MISURA PISCINA

ESPACIO NECESARIO
NECESSARY SPACE
ESPACE NECESSAIRE
SPAZIO NECESSARIO

Model	Dimensions (cm)	Necessary Space (cm)
KPEOV8027	800x400x120	1000x600x135
KPEOV7027	700x320x120	900x520x135
KPEOV6027	600x320x120	800x520x135
KPEOV5027	500x300x120	700x500x135



Liner PVC azul
60/100
PVC blue liner
60/100
Liner bleu PVC
60/100
Liner blu PVC
60/100

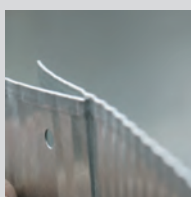

Chapa prelacada
60/100
Prelacquered steel
60/100
Tôle prélaquée
60/100
Lamiere laccata
60/100



Depuradora arena
(Caudal grupo 10/8 m³/h)
Sand filter
(Flow group 10/8 m³/h)
Filtre à sable
(Débit groupe 10/8 m³/h)
Filtro a sabbia
(Portata gruppo 10/8 m³/h)



EAN 13

	Ø	cm	l	kg	1/120x80 1/90x80	10m ³ /h	√	
KPE4227	Ø420 cm	120 cm	14.540 l	222/102 kg	1/120x80 1/90x80	10m ³ /h	√	8 412081 269399
KPE3527	Ø350 cm	120 cm	10.102 l	222/85 kg	1/120x80 1/90x80	10m ³ /h	√	8 412081 262635



MEDIDA PISCINA
POOL SIZE
DIMENSIONS PISCINE
MISURA PISCINA

ESPACIO NECESARIO
NECESSARY SPACE
ESPACE NECESSAIRE
SPAZIO NECESSARIO

KPE4227	Ø420x120 cm	Ø620x135 cm
KPE3527	Ø350x120 cm	Ø550x135 cm



Escalera:
3 peldaños - Inox.
Ladder:
3 steps - Stainless steel
Echelle:
3 marches - Acier inoxydable
Scala:
3 gradini - Inox

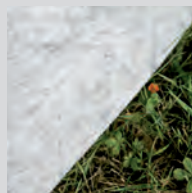

Manta protectora
(Poliéster)
Bottom protectiveblanket
(Polyester)
Tapis de sol en feutre
(Polyester)
Telo di protezione
(Poliestere)



Skimmer, manguera,
racordería...
Skimmer, hose,
fittings...
Skimmer, tuyau,
raccords...
Skimmer, tubi , kit
raccordi...





PISCINAS DE MADERA

LINER: Tratamiento Anti-ultravioleta que retrasa el envejecimiento del P.V.C

MADERA: Fabricadas en Francia en pino silvestre francés y con tratamiento en autoclave clase IV que garantiza la resistencia de la madera contra el ataque de insectos y pudrimiento. 10 años de garantía sobre la madera.

WOODEN POOL

LINER: Anti-ultraviolet treatment to slow down P.V.C aging.

WOODEN: Manufactured in France from pine boards (originating in France), with a class IV autoclave treatment which guarantees its resistance to decay and xylophagous insects attack.



PISCINE BOIS

LINER: Traitement anti-ultraviolets contre le vieillissement du P.V.C.

BOIS: De fabrication française et réalisées à partir de madriers en pin (origine France) bénéficiant d'un traitement par autoclave de classe IV, garantissant une résistance au pourrissement et aux attaques d'insectes xylophages.

PISCINA IN LEGNO

LINER: Trattamento Anti-ultravioletti - Ritarda l'invecchiamento del P.V.C.

LEGNO: Prodotte in Francia in pino silvestre francese con trattamento in autoclave classe IV che garantisce la resistenza del legno agli insetti e al deterioramento. 10 anni di garanzia sulle parti in legno.



**MADE
IN
EU**

wooden pool

VIOLETTE · VANILLE · LILI

H. 1,19 - 1,24m



	REFERENCIA RÉFERENCE	REFERENCE RIFERIMENTO
	CÓDIGO EAN GENCOD	EAN CODE CODICE A BARRE
	EXTERIORES EXTÉRIEURES	OUTSIDE ESTERNO
	INTERIORES INTÉRIEURES	INSIDE INTERNI
	VOLUMEN DE AGUA VOLUME D'EAU	WATER VOLUME VOLUME DI ACQUA
	PANELES PANS	PANELS PANNELLI
	LINEA DE AGUA LIGNE D'EAU	WATER LINE LINEA DELL'ACQUA
	ESTRUCTURA STRUCTURE	STRUCTURE STRUTTURA
	PLAYAS MARGELLES	EDGES BORDI
	ESPESOR MADERA ÉPAISEUR MADRIER	WOOD THICKNESS DIMENSIONE
	LINER	
	FILTRACIÓN FILTRATION	FILTRATION FILTRO
	PROTECTOR DE FONDO FEUTRE DE FOND	FLOOR PROTECTOR PROTEZIONE DEL FONDO
	PROTECTOR DE PARED FEUTRE DE PAROI	WALL PROTECTOR COPERTURA DELLA PARETE
	ESCALERA INTERIOR ÉCHELLE INTÉRIEURE	INSIDE LADDER SCALA INTERNA
	ESCALERA EXTERIOR ÉCHELLE EXTÉRIEURE	OUTSIDE LADDER SCALA ESTERNA
	TERRENO SUPPORT	LAND TERRENO
	PALET	
	IMPLANTATION	

VIOLETTE

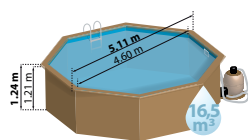

VANILLE

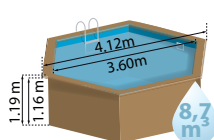

LILI



790085

790083

790080



Ø 5,11 x H. 1,24 m

Ø 4,12 x H. 1,19 m

Ø 2,95 x H. 1,05 m

Ø 4,60 x H. 1,21 m

Ø 3,60 x H. 1,16 m

Ø 2,55 x H. 0,90 m

16,5 m³

8,7 m³

4 m³

8

6

6

1,11 m

1,06 m

1,06 m

Pino silvestre francés y autoclave clase IV · Pine boards originating in France, with a class IV autoclave · Pin sylvestre origine France autoclave classe IV · pino silvestre francese con trattamento in autoclave classe IV - Certificado · Certificate · Certifié · Certificato **PEFC**

Ancho · width · largeur · larghezza: 29 cm, Espesor · Thickness · épaisseur · dimensione: 2,8 cm
Embellecedores metálicos · metal covers · caches angles inox · protezione metallo inox

Ancho · width · largeur · larghezza: 19 cm, Espesor · Thickness · épaisseur · dimensione: 2,8cm

46 mm

46 mm

46 mm

75/100^e uni

50/100^e uni

50/100^e uni

FILTRO DE ARENA · SAND FILTER · FILTRATION À SABLE · FILTRO A SABBIA

Aqualoon

6 m³ /h

4 m³/h

4 m³/h

Espeor · Thickness · Épaisseur · Dimensione
200 g/m²



ACERO INOXIDABLE · STAINLESS STEEL · ACIER INOXIDABLE · ACCIAIO INOX

Escalera seguridad plataforma
Safety ladder platform
Échelle sécurité plateforme
Scala di sicurezza piattaforma

MADERA · WOOD · BOIS · LEGNO

Losa de hormigón opcional · Optional concrete slab · Chape béton facultative · Basamento di calcestruzzo opzionale

474 x 474 x H 10 cm
2,25 m³

406 x 406 x H 10 cm
1,64 m³

306 x 306 x H 10 cm
0,94 m³

L 200 x l 120 x H 71 cm - 880 kg
L 80 x l 120 x H 78 cm - 120 kg

L 210 x l 120 x H 59 cm - 620 kg
L 80 x l 120 x H 78 cm - 105 kg

L 150 x l 120 x H 55 cm - 460 kg
L 80 x l 120 x H 115 cm - 62,5 kg

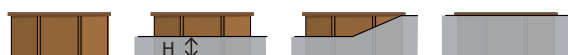

wooden pool

AVILA · SEVILLA · VERMELA

H. 1,46 m



	REFERENCIA RÉFERENCE	REFERENCE RIFERIMENTO
	CÓDIGO EAN GENCOD	EAN CODE CODICE A BARRE
	EXTERIORES EXTÉRIEURES	OUTSIDE ESTERNO
	INTERIORES INTÉRIEURES	INSIDE INTERNI
	VOLUMEN DE AGUA VOLUME D'EAU	WATER VOLUME VOLUME DI ACQUA
	PANELES PANS	PANELS PANNELLI
	LINEA DE AGUA LIGNE D'EAU	WATER LINE LINEA DELL'ACQUA
	ESTRUCTURA STRUCTURE	STRUCTURE STRUTTURA
	PLAYAS MARGELLES	EDGES BORDI
	ESPEJOR MADERA ÉPAISEUR MADRIER	WOOD THICKNESS DIMENSIONE
	LINER	
	FILTRACIÓN FILTRATION	FILTRATION FILTRO
	PROTECTOR DE FONDO FEUTRE DE FOND	FLOOR PROTECTOR PROTEZIONE DEL FONDO
	PROTECTOR DE PARED FEUTRE DE PAROI	WALL PROTECTOR COPERTURA DELLA PARETE
	ESCALERA INTERIOR ÉCHELLE INTÉRIEURE	INSIDE LADDER SCALA INTERNA
	ESCALERA EXTERIOR ÉCHELLE EXTÉRIEURE	OUTSIDE LADDER SCALA ESTERNA
	TERRENO SUPPORT	LAND TERRENO
	PALET	
	IMPLANTATION	

AVILA

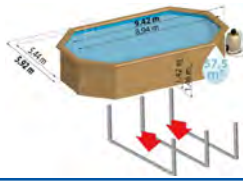

SEVILLA

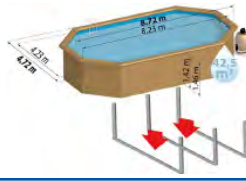

VERMELA



790092

790091

790090



9,42 x 5,92 x H. 1,46 m

8,72 x 4,72 x H. 1,46 m

6,72 x 4,72 x 1,46 m

8,94 x 5,44 x H. 1,42 m

8,23 x 4,23 x H. 1,42 m

6,23 x 4,23 x 1,42 m

57,5 m³

42,5 m³

31 m³

8

8

8

1,36 m

1,36 m

1,36 m

Pino silvestre francés y autoclave clase IV · Pine boards originating in France, with a class IV autoclave · Pin sylvestre origine France autoclave classe IV · pino silvestre francese con trattamento in autoclave classe IV - Certificado · Certificate · Certifié · Certificato PEFC

Ancho · width · largeur · larghezza: 29 cm, Espesor · Thickness · épaisseur · dimensione: 3,6 cm
Embellecedores metálicos · metal covers · caches angles inox · protezione metallico inox

46 mm

46 mm

46 mm

75/100^e uni

75/100^e uni

75/100^e uni

FILTRO DE ARENA · SAND FILTER · FILTRATION À SABLE · FILTRO A SABBIA

16 m³ /h

12 m³/h

12 m³/h

Espesor · Thickness · Épaisseur · Dimensione
200 g/m²



ACERO INOXIDABLE · STAINLESS STEEL · ACIER INOXIDABLE · ACCIAIO INOX

MADERA · WOOD · BOIS · LEGNO

Losa de hormigón obligatorio · Obligatory concrete slab · Chape béton Obligatoire · Basamento di calcestruzzo obbligatorio

944 x 594 x H 17 cm
9,55 m³

874 x 474 x H 17 cm
7,04 m³

674 x 474 x H 17 cm
5,43 m³

L 600 x l 120 x H 70cm - 1700 kg
L 80 x l 200 x H 100 cm - 300 kg

L 600 x l 120 x H 70cm - 1500 kg
L 200 x l 80 x H 100 cm - 320 kg

L 410 x l 120 x H 70cm - 1250 kg
L 200 x l 80 x H 100 cm - 300 kg



wooden pool

SAFRAN · CANNELLE · GRENADE

H. 1,19 - 1,33m



	REFERENCIA RÉFÉRENCE	REFERENCE RIFERIMENTO
	CÓDIGO EAN GENCOD	EAN CODE CODICE A BARRE
	EXTERIORES EXTÉRIEURES	OUTSIDE ESTERNO
	INTERIORES INTÉRIEURES	INSIDE INTERNI
	VOLUMEN DE AGUA VOLUME D'EAU	WATER VOLUME VOLUME DI ACQUA
	PANELES PANS	PANELS PANNELLI
	LINEA DE AGUA LIGNE D'EAU	WATER LINE LINEA DELL'ACQUA
	ESTRUCTURA STRUCTURE	STRUCTURE STRUTTURA
	PLAYAS MARGELLES	EDGES BORDI
	ESPESOR MADERA ÉPAISEUR MADRIER	WOOD THICKNESS DIMENSIONE
	LINER	
	FILTRACIÓN FILTRATION	FILTRATION FILTRO
	PROTECTOR DE FONDO FEUTRE DE FOND	FLOOR PROTECTOR PROTEZIONE DEL FONDO
	PROTECTOR DE PARED FEUTRE DE PAROI	WALL PROTECTOR COPERTURA DELLA PARETE
	ESCALERA INTERIOR ÉCHELLE INTÉRIEURE	INSIDE LADDER SCALA INTERNA
	ESCALERA EXTERIOR ÉCHELLE EXTÉRIEURE	OUTSIDE LADDER SCALA ESTERNA
	TERRENO SUPPORT	LAND TERRENO
	PALET	
	IMPLANTATION	

SAFRAN



CANNELLE

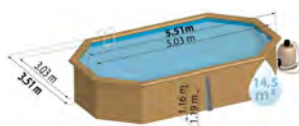

GRENADE

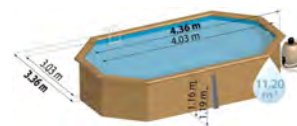

790089

790087

790086



6,37 x 4,12 x H. 1,33 m

5,51 x 3,51 x H. 1,19 m

4,36 x 3,36 x H. 1,19 m

5,90 x 3,65 x H. 1,30 m

5,03 x 3,03 x H. 1,16 m

4,03 x 3,03 x H. 1,16 m

23 m³

14,5 m³

11,2 m³

8

8

8

1,11 m

1,06 m

1,06 m

Pino silvestre francés y autoclave clase IV · Pine boards originating in France, with a class IV autoclave · Pin sylvestre origine France autoclave classe IV · pino silvestre francese con trattamento in autoclave classe IV - Certificado · Certificate · Certifié · Certificato PEFC

Ancho · width · largeur · larghezza: 19 cm (GRENADE), 29 cm (SAFRAN y CANNELLE), Espesor · Thickness · épaisseur · dimensione: 2,8 cm
Embelledores metálicos · metal covers · caches angles inox · protezione metallo inox

46 mm

46 mm

46 mm

75/100^e uni

60/100^e uni

60/100^e uni

FILTRO DE ARENA · SAND FILTER · FILTRATION À SABLE · FILTRO A SABBIA

8 m³/h

6 m³/h

4 m³/h

Espesor · Thickness · Épaisseur · Dimensione
200 g/m²



ACERO INOXIDABLE · STAINLESS STEEL · ACIER INOXIDABLE · ACCIAIO INOX

MADERA · WOOD · BOIS · LEGNO

Losa de hormigón obligatorio · Obligatory concrete slab · Chape béton Obligatoire · Basamento di calcestruzzo obbligatorio

638 x 463 x H 15 cm
4,43 m³

553 x 403 x H 15 cm
3,34 m³

453 x 403 x H 15 cm
2,74 m³

L 400 x l 120 x H 58 cm - 1140 kg
L 80 x l 120 x H 100 cm - 120 kg

L 350 x l 120 x H 46 cm - 880 kg
L 80 x l 120 x H 100 cm - 90 kg

L 300 x l 120 x H 48 cm - 720 kg
L 80 x l 120 x H 78 cm - 100 kg

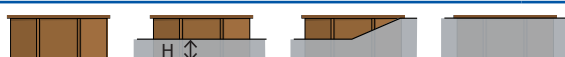

wooden pool

CARDAMON · MINT · ANISE

H. 1,46 m



	REFERENCIA RÉFÉRENCE	REFERENCE RIFERIMENTO
	CÓDIGO EAN GENCOD	EAN CODE CODICE A BARRE
	EXTERIORES EXTÉRIEURES	OUTSIDE ESTERNO
	INTERIORES INTÉRIEURES	INSIDE INTERNI
	VOLUMEN DE AGUA VOLUME D'EAU	WATER VOLUME VOLUME DI ACQUA
	PANELES PANS	PANELS PANNELLI
	LINEA DE AGUA LIGNE D'EAU	WATER LINE LINEA DELL'ACQUA
	ESTRUCTURA STRUCTURE	STRUCTURE STRUTTURA
	PLAYAS MARGELLES	EDGES BORDI
	ESPESOR MADERA ÉPAISEUR MADRIER	WOOD THICKNESS DIMENSIONE
	LINER	
	FILTRACIÓN FILTRATION	FILTRATION FILTRO
	PROTECTOR DE FONDO FEUTRE DE FOND	FLOOR PROTECTOR PROTEZIONE DEL FONDO
	PROTECTOR DE PARED FEUTRE DE PAROI	WALL PROTECTOR COPERTURA DELLA PARETE
	ESCALERA INTERIOR ÉCHELLE INTÉRIEURE	INSIDE LADDER SCALA INTERNA
	ESCALERA EXTERIOR ÉCHELLE EXTÉRIEURE	OUTSIDE LADDER SCALA ESTERNA
	TERRENO SUPPORT	LAND TERRENO
	PALET	
	IMPLANTATION	

CARDAMON

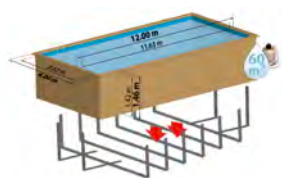

MINT



ANISE



788033

788032

788031



12,00 x 4,00 x H. 1,46 m

10,00 x 4,00 x H. 1,46 m

9,00 x 3,00 x H. 1,46 m

11,63 x 3,52 x H. 1,42 m

9,63 x 3,52 x H. 1,42 m

8,63 x 2,52 x H. 1,42 m

60 m³

50 m³

35 m³

4

4

4

1,36 m

1,36 m

1,36 m

Pino silvestre francés y autoclave clase IV · Pine boards originating in France, with a class IV autoclave · Pin sylvestre origine France autoclave classe IV · pino silvestre francese con trattamento in autoclave classe IV - Certificado · Certificate · Certifié · Certificato PEFC

Ancho · width · largeur · larghezza: 29 cm, Espesor · Thickness · épaisseur · dimensione: 3,6 cm
Embellecedores metálicos · metal covers · caches angles inox · protezione metallo inox

46 mm

46 mm

46 mm

75/100^e uni

75/100^e uni

75/100^e uni

FILTRO DE ARENA · SAND FILTER · FILTRATION À SABLE · FILTRO A SABBIA

16 m³ /h

16 m³/h

16 m³/h

Espesor · Thickness · Épaisseur · Dimensione
200 g/m²



ACERO INOXIDABLE · STAINLESS STEEL · ACIER INOXIDABLE · ACCIAIO INOX

MADERA · WOOD · BOIS · LEGNO

Losa de hormigón obligatorio · Obligatory concrete slab · Chape béton Obligatoire · Basamento di calcestruzzo obbligatorio

1300 x 500 x H 17 cm
11,05 m³

1100 x 500 x H 17 cm
9,35 m³

1000 x 400 x H 17 cm
6,8 m³

L 500 x l 120 x H 120 cm - 3000 kg
L 80 x l 200 x H 100 cm - 300 kg

L 600 x l 120 x H 120 cm - 2500 kg
L 200 x l 80 x H 100 cm - 300 kg

L 500 x l 120 x H 120 cm - 2000 kg
L 200 x l 80 x H 100 cm - 300 kg



wooden pool

BRAGA · EVORA · MARBELLA · CARRA

H. 1,19 m - H. 1,33 m - H. 1,46 m



	REFERENCIA RÉFERENCE	REFERENCE RIFERIMENTO
	CÓDIGO EAN GENCOD	EAN CODE CODICE A BARRE
	EXTERIORES EXTÉRIEURES	OUTSIDE ESTERNO
	INTERIORES INTÉRIEURES	INSIDE INTERNI
	VOLUMEN DE AGUA VOLUME D'EAU	WATER VOLUME VOLUME DI ACQUA
	PANELES PANS	PANELS PANNELLI
	LINEA DE AGUA LIGNE D'EAU	WATER LINE LINEA DELL'ACQUA
	ESTRUCTURA STRUCTURE	STRUCTURE STRUTTURA
	PLAYAS MARGELLES	EDGES BORDI
	ESPESOR MADERA ÉPAISEUR MADRIER	WOOD THICKNESS DIMENSIONE
	LINER	
	FILTRACIÓN FILTRATION	FILTRATION FILTRO
	PROTECTOR DE FONDO FEUTRE DE FOND	FLOOR PROTECTOR PROTEZIONE DEL FONDO
	PROTECTOR DE PARED FEUTRE DE PAROI	WALL PROTECTOR COPERTURA DELLA PARETE
	ESCALERA INTERIOR ÉCHELLE INTÉRIEURE	INSIDE LADDER SCALA INTERNA
	ESCALERA EXTERIOR ÉCHELLE EXTÉRIEURE	OUTSIDE LADDER SCALA ESTERNA
	TERRENO SUPPORT	LAND TERRENO
	PALET	
	IMPLANTATION	

BRAGA



EVORA

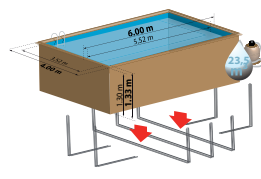

MARBELLA



CARRA

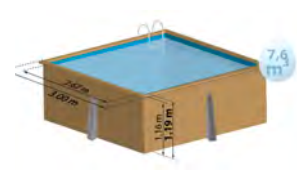

790095

790094

790096

790093



8,00 x 4,00 x H. 1,46 m

6,00 x 4,00 x H. 1,33 m

4,00 x 2,50 x H. 1,19 m

3,00 x 3,00 x H. 1,19 m

7,52 x 3,52 x H. 1,42 m

5,52 x 3,52 x H. 1,30 m

3,79 x 2,29 x H. 1,16 m

2,67 x 2,67 x H. 1,16 m

37 m³23,5 m³10 m³7,6 m³

4

4

4

4

1,34 m

1,20 m

1,06 m

1,06 m

Pino silvestre francés y autoclave clase IV · Pine boards originating in France, with a class IV autoclave · Pin sylvestre origine France autoclave classe IV ·
pino silvestre francese con trattamento in autoclave classe IV - Certificado · Certificate · Certifié · Certificato PEFC

Ancho · width · largeur · larghezza: 19 cm (CARRA), 29 cm, Espesor · Thickness · épaisseur · dimensione: 2,8 cm, 3,6 cm (BRAGA)
Embellecedores metálicos · metal covers · caches angles inox · protezione metallo inox

46 mm

46 mm

46 mm

46 mm

75/100^e uni75/100^e uni75/100^e uni60/100^e uni

FILTRO DE ARENA · SAND FILTER · FILTRATION À SABLE · FILTRO A SABBIA

12 m³ /h8 m³/h6 m³/h4 m³/h

Espesor · Thickness · Épaisseur · Dimensione
200 g/m²



ACERO INOXIDABLE · STAINLESS STEEL · ACIER INOXIDABLE · ACCIAIO INOX

MADERA · WOOD · BOIS · LEGNO

Losa de hormigón obligatorio · Obligatory concrete slab · Chape béton Obligatoire · Basamento di calcestruzzo obbligatorio

900 x 500 x H 17 cm
7,65 m³

700 x 500 x H 17 cm
5,95 m³

500 x 350 x H 15 cm
2,62 m³

400 x 400 x H 15 cm
2,4 m³

L 500 x l 120 x H 100 cm - 1500kg
L 200 x l 80 x H 100 cm - 120 kg

L 600 x l 120 x H 70 cm - 1700 kg
L 80 x l 120 x H 100 cm - 300 kg

L 400 x l 120 x H 41,5 cm - 600 kg
L 80 x l 200 x H 100 cm - 120 kg

L 300 x l 120 x H 50 cm - 900 kg
L 80 x l 120 x H 78 cm - 100 kg

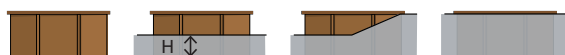



Avantgarde ^{POOLS}

PISCINAS DE COMPOSITE

LINER: Tratamiento Anti-ultravioleta que retrasa el envejecimiento del P.V.C

COMPOSITE: Las piscinas de composite están fabricadas de un nuevo material mezcla de madera (harina de madera) y polímeros.

PISCINES COMPOSITE

LINER: Traitement anti-ultraviolets contre le vieillissement du P.V.C.

COMPOSITE: Les piscines "composite" sont fabriquées avec un nouveau matériau composé d'un mélange de bois (farine de bois) et de polymères.

COMPOSITE POOLS

LINER: Anti-ultraviolet treatment to slow down P.V.C aging.

COMPOSITE: Composite pools are made of a new material mix of wood (wood flour) and polymers.

PISCINA IN COMPOSITE

LINER: Trattamento Anti-ultravioletti - Ritarda l'invecchiamento del P.V.C.

COMPOSITE: Le piscine in composite vengono prodotte con un nuovo materiale composto da una miscela di legno (farina di legno) e polimeri.



Resina plástica
Plastic resin
Résine plastique
Resina plastica



Serrín
Sawdust
Farine de bois
Segatura



Pigmento
Pigments
Pigments
Pigmenti



Aditivos con carga mineral
Mineral additives
Additifs Charge minérale
Additivi con carica minerale

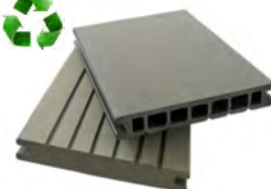

**DESIGNED &
ASSEMBLED
IN EU**

composite pool



KPCOR60



EAN 13

KPCOR60

674x368 cm

124 cm

17.875 l

1220 kg

1/170x130

5m³/h

√

√

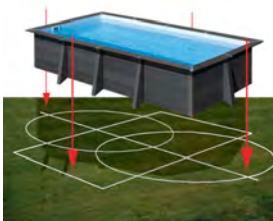

MEDIDA PISCINA
POOL SIZE
DIMENSIONS PISCINE
MISURA PISCINA

ESPACIO NECESARIO
NECESSARY SPACE
ESPACE NECESSAIRE
SPAZIO NECESSARIO

KPCOR60

674x368 cm

874x568 cm



Liner PVC azul
60/100
PVC blue liner
60/100
Liner PVC bleu
60/100
Liner PVC blu
60/100

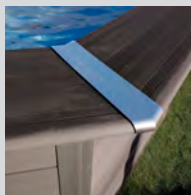

Embellecedores de
aluminio
Aluminium trims
Protections en
aluminium
Profili in
alluminio

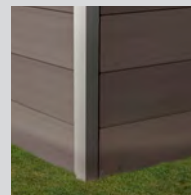

Perfilería de acero
Steel profiles
Poteaux et margelles
acier
Profili in acciaio



La cuña metálica se fija sobre la losa de cemento. Así, es necesario realizar la losa, de 15cm de espesor mínimo, previamente al montaje de la piscina.

The wedge is fixed over the concrete slab. In such a way, it is possible to make the slab, of 15cm minimum, beforehand to the assembly of the pool.

Le sabot vient se fixer sur la dalle en béton. Il est donc possible de réaliser la dalle, épaisseur 15 cm minimum, préalablement au montage du bassin.

Il cuneo metallico si fissa sopra il massetto di cemento. Quindi è necessario realizzare il massetto dello spessore minimo di 15cm prima del montaggio della piscina.

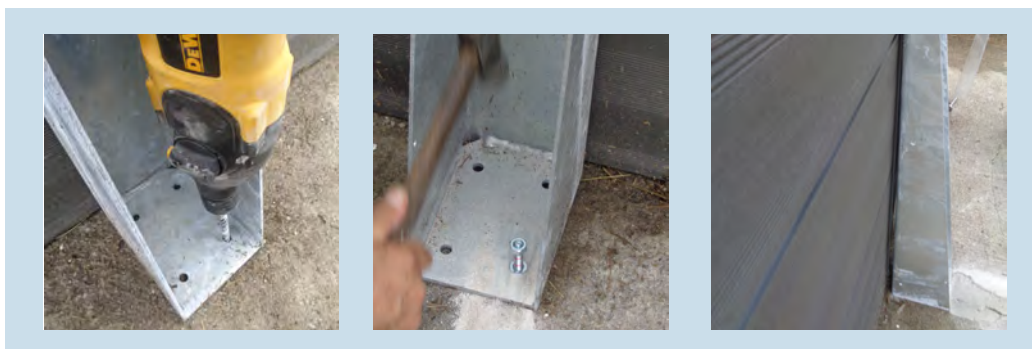

Cuña metálica Metallic wedge Sabots Cuneo metallico



Depuradora arena
(Caudal grupo 5 m³/h)
Sand filter
(Flow group 5 m³/h)
Filtre à sable
(Débit groupe 5 m³/h)
Filtro a sabbia
(Portata gruppo 5 m³/h)

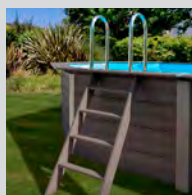

Escalera:
- Composite / acero inoxidable
Ladder:
- Composite / stainless steel
Échelle:
- Composite / acier inoxydable
Scale:
- Composite / acciaio inox

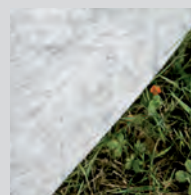

Manta protectora
(Poliéster)
Bottom protectiveblanket
(Polyester)
Tapis de sol en feutre
(Polyester)
Telo di protezione
(Poliestere)

composite pool



KPCOV52



EAN 13

	804x386 cm	664x386 cm	524x386 cm
KPCOV80	804x386 cm	664x386 cm	524x386 cm
KPCOV66	124 cm	124 cm	124 cm
KPCOV52	27.000 l	21.500 l	16.210 l
	1450 kg	1220 kg	960 kg
	1/170x150	1/170x150	1/170x130
	5m ³ /h	4m ³ /h	4m ³ /h
	√	√	√
	√	√	√
	8 412081 268804	8 412081 268798	8 412081 268781

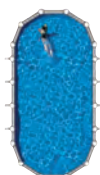
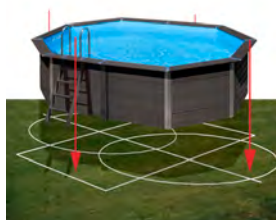

MEDIDA PISCINA
POOL SIZE
DIMENSIONS PISCINE
MISURA PISCINA

ESPACIO NECESARIO
NECESSARY SPACE
ESPACE NECESSAIRE
SPAZIO NECESSARIO

KPCOV80	804x386 cm	844x506 cm
KPCOV66	664x386 cm	704x506 cm
KPCOV52	524x386 cm	564x506 cm



Liner PVC azul
60/100
PVC blue liner
60/100
Liner PVC bleu
60/100
Liner PVC blu
60/100

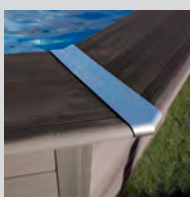

Embellecedores de
aluminio
Aluminium trims
Protections en
aluminium
Profili in
alluminio

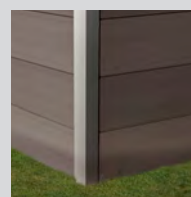

Perfilería de acero
Steel profiles
Poteaux et marges
acier
Profili in acciaio



KPC041



EAN 13

KPC041

Ø 410 cm

124 cm

11.000 l

705 kg

1/170x130

3m³/h

√

√

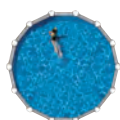

MEDIDA PISCINA
POOL SIZE
DIMENSIONS PISCINE
MISURA PISCINA

ESPACIO NECESARIO
NECESSARY SPACE
ESPACE NECESSAIRE
SPAZIO NECESSARIO

KPC041

Ø 410cm

450x450 cm



Depuradora arena
(Caudal grupo 5/4/3 m³/h)
Sand filter
(Flow group 5/4/3 m³/h)
Filtre à sable
(Débit groupe 5/4/3 m³/h)
Filtro a sabbia
Portata gruppo 5/4/3 m³/h

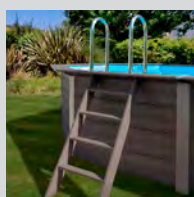

Escalera:
- Composite / acero inoxidable
Ladder:
- Composite / stainless steel
Échelle:
- Composite / acier inoxydable
Scale:
- Composite / acciaio inox

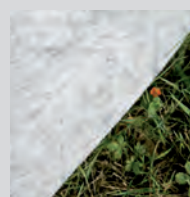

Manta protectora
(Poliéster)
Bottom protectiveblanket
(Polyester)
Tapis de sol en feutre
(Polyester)
Telo di protezione
(Poliestere)

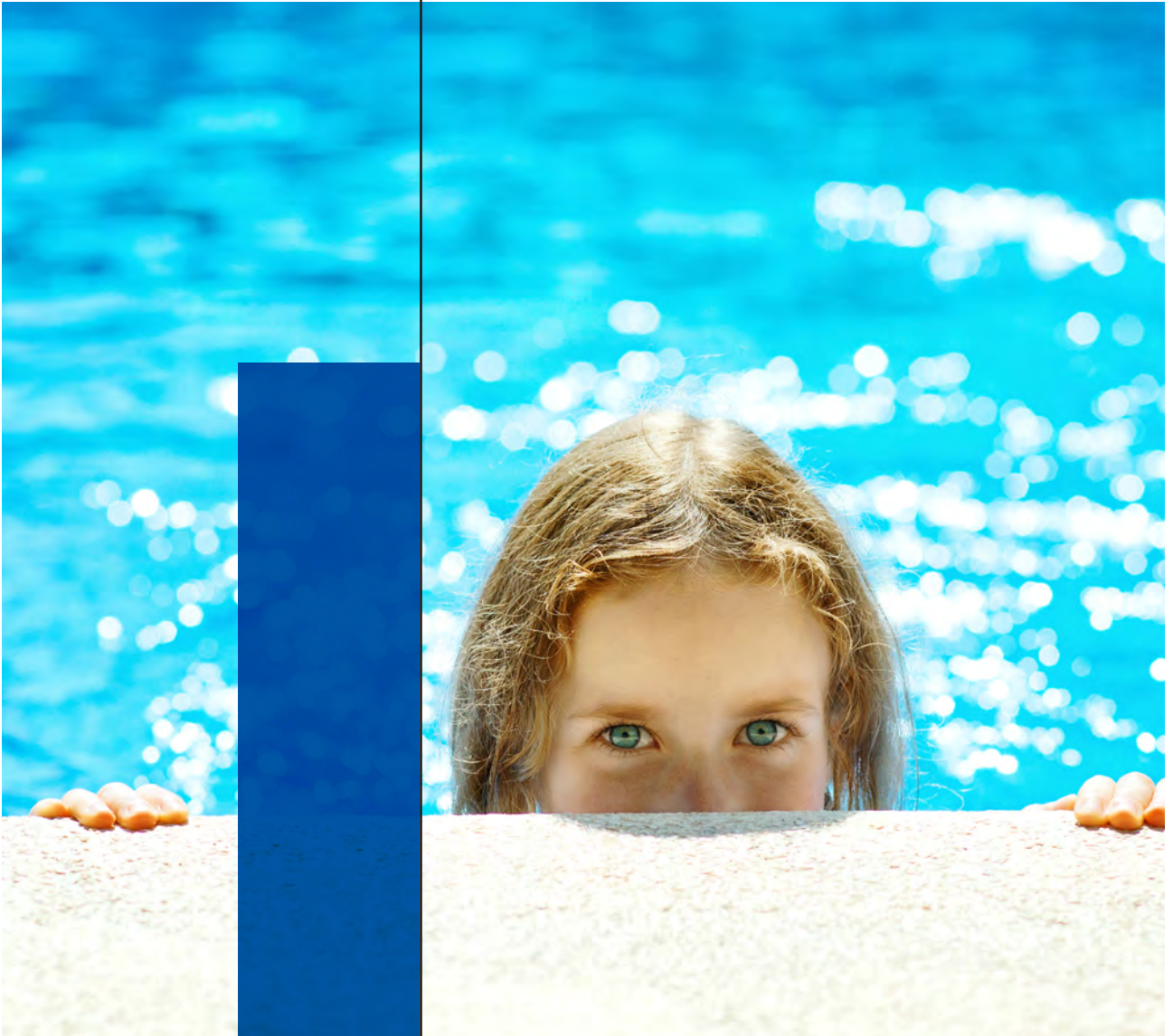



PISCINA DE PARED DE ACERO

LINER: Tratamiento Anti - Ultravioleta que retrasa el envejecimiento del P.V.C.

PARED: laminada en frío con tratamiento de galvanización, fosfatación, imprimación y lacado.

Perfilación vertical de la misma para la obtención de una mayor resistencia.

Troquelada para skimmer y válvula de retorno del agua.

PIEZAS ESTRUCTURALES: De acero.

PERFILES Y PLAYAS: Polipropileno

PISCINE PAROI ACIER

LINER: Traitement anti-ultraviolets contre le vieillissement du P.V.C.

PAROI: Tôle laminée à froid et traitée par galvanisation, phosphatage, couche d'apprêt et laquage.

Profils verticaux pour une meilleure résistance.

Découpage pour le skimmer et la buse de refoulement.

PIÈCES STRUCTURELLES:: Métalliques

STRUCTURE E MARGELLES: Polypropylène



STEEL WALL POOL

LINER: Anti-ultraviolet treatment to slow down P.V.C aging.

WALL: Galvanized, phosphatized, primed and lacquered cold-rolled plate .

Vertical sectioning for an increased strength . Die cut for skimmer and water return valve openings.

STRUCTURAL PARTS: Steel

PROFILES AND EDGES: Polypropylene

PISCINA CON PARETI IN ACCIAIO

LINER: Trattamento Anti-ultravioletti - Ritarda l'invecchiamento del P.V.C.

PARETE: Laminata a freddo con trattamento di galvanizzazione, fosfatazione e preparazione.

Preparazione verticale per ottenere una maggiore resistenza.

Stampigliatura per Skimmer e valvola di ritorno dell'acqua.

PEZZI STRUTTURALI: Acciaio.

PROFILI ED PROFILI SUPERIORI: Polipropilene



Fusion pool

KITPROV760H



EAN 13

	760x460 cm	135 cm	35.200 l	375 kg	1/120x80	7m ³ /h	√	√	8 4 1 2 0 8 1 2 7 3 5 5 6
KITPROV760H	760x460 cm	135 cm	35.200 l	375 kg	1/120x80	7m ³ /h	√	√	
KITPROV670H	670x370 cm	135 cm	25.200 l	315 kg	1/120x80	4m ³ /h	√	√	
KITPROV520H	520x370 cm	135 cm	18.700 l	295 kg	1/120x80	4m ³ /h	√	√	

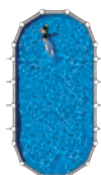
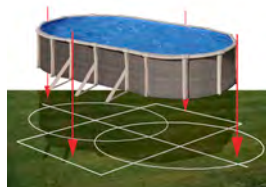

MEDIDA PISCINA
POOL SIZE
DIMENSIONS PISCINE
MISURA PISCINA

ESPACIO NECESARIO
NECESSARY SPACE
ESPACE NECESSAIRE
SPAZIO NECESSARIO

KITPROV760H	760x460 cm	860x660 cm
KITPROV670H	670x370 cm	770x570 cm
KITPROV520H	520x370 cm	620x570 cm



Liner PVC azul
40/100
PVC blue liner
40/100
Liner PVC bleu
40/100
Liner PVC blu
40/100

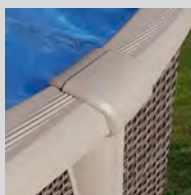

Embelledores de
Polipropileno
Polypropylene trims
Protections en
polypropylène
Profili in
polipropilene

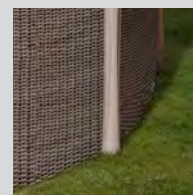

Perfilería de
Polipropileno
Polypropylene
profiles
Poteaux et margelles
polypropylène
Profili in polipropilene

KITPR460H



EAN 13

KITPR460H

Ø 460 cm

135 cm

19.200 l

237,5 kg

1/90x80

5m³/h

√

√

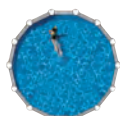

MEDIDA PISCINA
POOL SIZE
DIMENSIONS PISCINE
MISURA PISCINA

ESPACIO NECESARIO
NECESSARY SPACE
ESPACE NECESSAIRE
SPAZIO NECESSARIO

KITPR460H

Ø 460 cm

500x500 cm



Depuradora arena
(Caudal grupo 7/5/4 m³/h)
Sand filter
(Flow group 7/5/4 m³/h)
Filtre à sable
(Débit groupe 7/5/4 m³/h)
Filtro a sabbia
(Portata gruppo 7/5/4 m³/h)

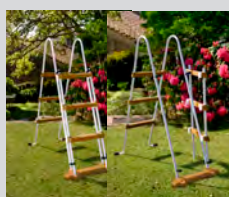

Escalera de seguridad
2x3 Peldaños
Safety Ladder
2x3 Steps
Échelle sécurité
2x3 Marches
Scala di sicurezza
2x3 Gradini

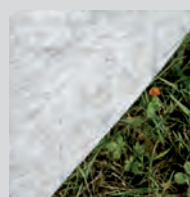

Manta protectora
(Poliéster)
Bottom protectiveblanket
(Polyester)
Tapis de sol en feutre
(Polyester)
Telo di protezione
(Poliestere)





PISCINA DE PARED DE ACERO

LINER: Tratamiento Anti - Ultravioleta que retrasa el envejecimiento del P.V.C.

CHAPA: laminada en frío con tratamiento de galvanización, fosfatación, imprimación y lacado.

Perfilación vertical de la misma para la obtención de una mayor resistencia.

Troquelada para skimmer y válvula de retorno del agua.

PIEZAS ESTRUCTURALES: De acero.

PISCINE PAROI ACIER

LINER: Traitement anti-ultraviolets contre le vieillissement du P.V.C.

TÔLE: Tôle laminée à froid et traitée par galvanisation, phosphatage, couche d'apprêt et laquage.

Profilés verticaux pour une meilleure résistance.

Découpage pour le skimmer et la buse de refoulement.

PIÈCES STRUCTURELLES:: Métalliques

STEEL WALL POOL

LINER: Anti-ultraviolet treatment to slow down P.V.C aging.

PLATE: Galvanized, phosphatized, primed and lacquered cold-rolled plate .

Vertical sectioning for an increased strength . Die cut for skimmer and water return valve openings.

STRUCTURAL PARTS: Steel

PISCINA CON PARETI IN ACCIAIO

LINER: Trattamento Anti-ultravioletti - Ritarda l'invecchiamento del P.V.C.

PANNELLO: Laminata a freddo con trattamento di galvanizzazione, fosfatazione e preparazione.

Preparazione verticale per ottenere una maggiore resistenza.

Stampigliatura per Skimmer e valvola di ritorno dell'acqua.

PEZZI STRUTTURALI: Acciaio.

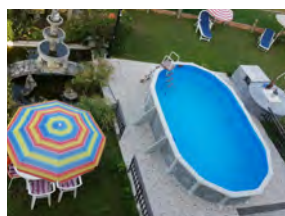

**MADE
IN
EU**

dream pool serie **CAPRI**

KITPROV7388GF



EAN 13

Model	Dimensions (LxW)	Height	Capacity (l)	Weight (kg)	Box Size (LxW)	Flow Rate (m³/h)	Filter	Ladder	Accessories	Space (LxW)	Barcode
KITPROV7388GF	730x375 cm	132 cm	28.217 l	348 kg	1/120x80	5m³/h	√	√	15	12	8 412081 272382
KITPROV6188GF	610x375 cm	132 cm	23.281 l	279 kg	1/90x80	5m³/h	√	√	15	12	8 412081 272399

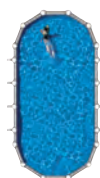
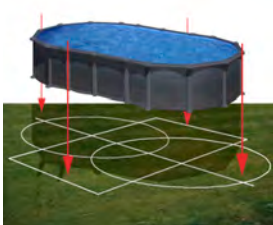

MEDIDA PISCINA
POOL SIZE
DIMENSIONS PISCINE
MISURA PISCINA

ESPACIO NECESARIO
NECESSARY SPACE
ESPACE NECESSAIRE
SPAZIO NECESSARIO

Model	Pool Size	Necessary Space
KITPROV7388GF	730x375 cm	770x495 cm
KITPROV6188GF	610x375 cm	650x495 cm



Liner PVC azul
40/100
PVC blue liner
40/100
Liner PVC bleu
40/100
Liner PVC blu
40/100

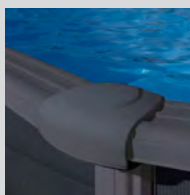

Protectores de
inyección
Injection saver
Protections moulées
par injection
Angolare di
protezione

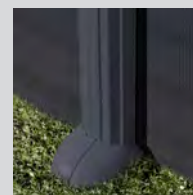

Perfilería de acero
Steel profiles
Poteaux et margelles
acier
Profili in acciaio



Viga de acero enterrada de 15x15 cm que hace innecesarios los postes exteriores, obteniendo mejor aprovechamiento del jardín.

15x15 cm buried steel beam makes unnecessary the outer buttress, optimizing the use of the garden area.

Poteaux en acier à enterrer de 15x15 cm évitant des renforts apparents extérieurs, pour mieux profiter de l'espace du jardin.

Barra di acciaio interrata da 15x15 cm che non rende necessario l'utilizzo delle barre laterali; permette di poter sfruttare al meglio gli spazi del proprio giardino.



Sistema de omegas Omega system Renforts enterrés Sistema omega



Depuradora arena
(Caudal grupo 5 m³/h)
Sand filter
(Flow group 5 m³/h)
Filtre à sable
(Débit groupe 5 m³/h)
Filtro a sabbia
(Portata gruppo 5)m³/h



Escalera de seguridad
Plataforma +2x3 Peldaños
Safety Ladder
Platform + 2x3 Steps
Échelle sécurité
Plateforme + 2x3 Marches
Scala di sicurezza
Piattaforma + 2x3 Gradini

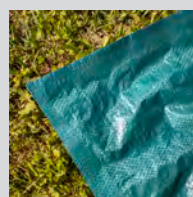

Tapiz protector
(Polietileno)
Floor tapestry
(Polythene)
Tapis de sol en feutre
(Polyéthylène)
Telo di protezione
(Polietilene)

dream pool serie GRANADA

KITPROV738GF



EAN 13

	730x375 cm	132 cm	28.217 l	335 kg	1/120x80	5m ³ /h	√	√	15	12	8 4 1 2 0 8 1 2 7 2 4 0 5
KITPROV738GF	730x375 cm	132 cm	28.217 l	335 kg	1/120x80	5m ³ /h	√	√	15	12	8 4 1 2 0 8 1 2 7 2 4 0 5
KITPROV618GF	610x375 cm	132 cm	23.281 l	270 kg	1/90x80	5m ³ /h	√	√	15	12	8 4 1 2 0 8 1 2 7 2 4 1 2
KITPROV508GF	500x300 cm	132 cm	16.210 l	260 kg	1/90x80	5m ³ /h	√	√	15	12	8 4 1 2 0 8 1 2 7 2 4 2 9

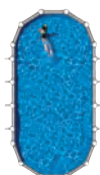
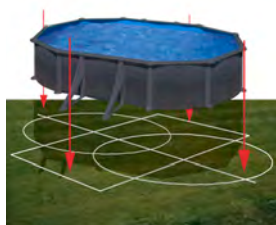

MEDIDA PISCINA
POOL SIZE
DIMENSIONS PISCINE
MISURA PISCINA

ESPACIO NECESARIO
NECESSARY SPACE
ESPACE NECESSAIRE
SPAZIO NECESSARIO

KITPROV738GF	730x375 cm	770x595 cm
KITPROV618GF	610x375 cm	650x595 cm
KITPROV508GF	500x300 cm	540x520 cm



Liner PVC azul
40/100
PVC blue liner
40/100
Liner PVC bleu
40/100
Liner PVC blu
40/100

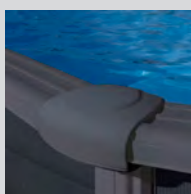

Protectores de
inyección
Injection saver
Protections moulées
par injection
Angolare di
protezione

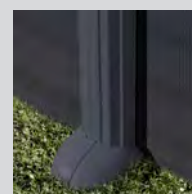

Perfilería de acero
Steel profiles
Poteaux et margelles
acier
Profili in acciaio

KITPR558GF



EAN 13

	Ø	Height	Volume	Weight	Box	Flow	✓	✓	Steps	Height	Length	Barcode
KITPR558GF	Ø550 cm	132 cm	27.798 l	243 kg	1/90x80	5m³/h	✓	✓	15	12	8 4 1 2 0 8 1 2 7 2 4 3 6	
KITPR458GF	Ø460 cm	132 cm	19.444 l	238 kg	1/90x80	5m³/h	✓	✓	15	12	8 4 1 2 0 8 1 2 7 2 4 4 3	
KITPR358GF	Ø350 cm	132 cm	11.250 l	184 kg	1/90x80	5m³/h	✓	✓	15	12	8 4 1 2 0 8 1 2 7 2 4 5 0	

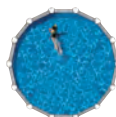
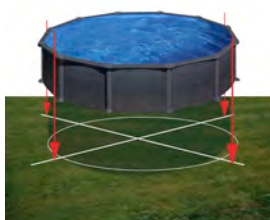

MEDIDA PISCINA
POOL SIZE
DIMENSIONS PISCINE
MISURA PISCINA

ESPACIO NECESARIO
NECESSARY SPACE
ESPACE NECESSAIRE
SPAZIO NECESSARIO

KITPR558GF	Ø 550cm	600x600 cm
KITPR458GF	Ø 460cm	500x500 cm
KITPR358GF	Ø 350cm	400x400 cm



Depuradora arena
(Caudal grupo 5 m³/h)
Sand filter
(Flow group 5 m³/h)
Filtre à sable
(Débit groupe 5 m³/h)
Filtro a sabbia
(Portata gruppo 5 m³/h)



Escalera de seguridad
Plataforma +2x3 Peldaños
Safety Ladder
Platform + 2x3 Steps
Échelle sécurité
Plateforme + 2x3 Marches
Scala di sicurezza
Piattaforma + 2x3 Gradini



Tapiz protector
(Poliétileno)
Floor tapestry
(Polythene)
Tapis de sol en feutre
(Polyéthylène)
Telo di protezione
(Poliétilene)

dream pool serie KEA

KIT610GF



EAN 13

	730x375 cm	610x375 cm	500x300 cm
KIT730GF	730x375 cm	610x375 cm	500x300 cm
KIT610GF	120 cm	120 cm	120 cm
KIT500GF	25.323 l	20.893 l	14.550 l
	287 kg	235 kg	198 kg
	1/90x80	1/80x60	1/80x60
	4m ³ /h	3m ³ /h	3m ³ /h
	√	√	√
	15	15	15
	12	12	12
	8 4 1 2 0 8 1 2 7 2 4 6 7	8 4 1 2 0 8 1 2 7 2 4 7 4	8 4 1 2 0 8 1 2 7 3 0 8 2

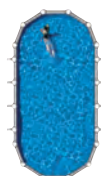
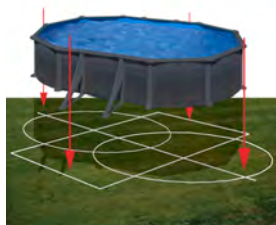

MEDIDA PISCINA
POOL SIZE
DIMENSIONS PISCINE
MISURA PISCINA

ESPACIO NECESARIO
NECESSARY SPACE
ESPACE NECESSAIRE
SPAZIO NECESSARIO

KIT730GF	730x375 cm	770x595 cm
KIT610GF	610x375 cm	650x595 cm
KIT500GF	500x300 cm	540x520 cm



Liner PVC azul
40/100
PVC blue liner
40/100
Liner PVC bleu
40/100
Liner PVC blu
40/100
KIT500/460/350GF: 30/100

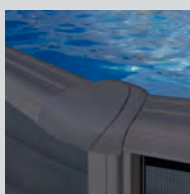

Protectores de
inyección
Injection saver
Protections moulées
par injection
Angolare di
protezione

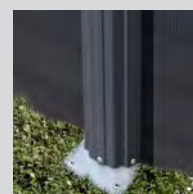

Perfilería de acero
Steel profiles
Poteaux et margelles
acier
Profili in acciaio



KIT350GF



EAN 13

KIT460GF	Ø460 cm	120 cm	17.450 l	172 kg	1/80x60	3m³/h	√	15	12	
KIT350GF	Ø350 cm	120 cm	10.102 l	146 kg	1/80x60	3m³/h	√	15	12	

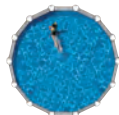
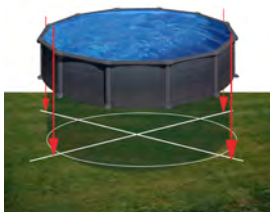

MEDIDA PISCINA
POOL SIZE
DIMENSIONS PISCINE
MISURA PISCINA

ESPACIO NECESARIO
NECESSARY SPACE
ESPACE NECESSAIRE
SPAZIO NECESSARIO

KIT460GF	Ø 460cm	500x500 cm
KIT350GF	Ø 350cm	400x400 cm



Depuradora arena
(Caudal grupo 3/4 m³/h)
Sand filter
(Flow group 3/4 m³/h)
Filtre à sable
(Débit groupe 3/4 m³/h)
Filtro a sabbia
(Portata gruppo 3/4 m³/h)

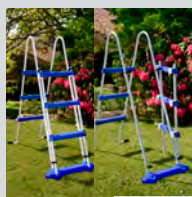

Escalera de seguridad
2x3 Peldaños
Safety Ladder
2x3 Steps
Échelle sécurité
2x3 Marches
Scala di sicurezza
2x3 Gradini

dream pool serie

SANTORINI

KITPROV7388PO



EAN 13

Model	Dimensions (LxW)	Depth	Volume	Weight	Box Size	Flow Rate	Filter	Ladder	Filter	Accessories	Barcode
KITPROV7388PO	730x375 cm	132 cm	28.217 l	348 kg	1/120x80	5m ³ /h	√	√	15	12	8 412081 264493
KITPROV6188PO	610x375 cm	132 cm	23.281 l	279 kg	1/90x80	5m ³ /h	√	√	15	12	8 412081 264509

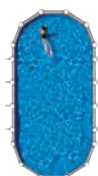
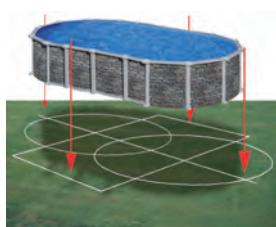

MEDIDA PISCINA
POOL SIZE
DIMENSIONS PISCINE
MISURA PISCINA

ESPACIO NECESARIO
NECESSARY SPACE
ESPACE NECESSAIRE
SPAZIO NECESSARIO

KITPROV7388P

730x375 cm

770x495 cm

KITPROV6188P

610x375 cm

650x495 cm



Liner PVC azul
40/100
PVC blue liner
40/100
Liner PVC bleu
40/100
Liner PVC blu
40/100



Protectores de
inyección
Injection saver
Protections moulées
par injection
Angolare di
protezione



Perfilería de acero
Steel profiles
Poteaux et margelles
acier
Profili in acciaio



Viga de acero enterrada de 15x15 cm que hace innecesarios los postes exteriores, obteniendo mejor aprovechamiento del jardín.

15x15 cm buried steel beam makes unnecessary the outer buttress, optimizing the use of the garden area.

Poteaux en acier à enterrer de 15x15 cm évitant des renforts apparents extérieurs, pour mieux profiter de l'espace du jardin.

Barra di acciaio interrata da 15x15 cm che non rende necessario l'utilizzo delle barre laterali; permette di poter sfruttare al meglio gli spazi del proprio giardino.



Sistema de omegas Omega system Renforts enterrés Sistema omega



Depuradora arena
(Caudal grupo 5 m³/h)
Sand filter
(Flow group 5 m³/h)
Filtre à sable
(Débit groupe 5 m³/h)
Filtro a sabbia
(Portata gruppo 5 m³/h)



Escalera de seguridad
Plataforma +2x3 Peldaños
Safety Ladder
Platform + 2x3 Steps
Échelle sécurité
Plateforme + 2x3 Marches
Scala di sicurezza
Piattaforma + 2x3 Gradini



Tapiz protector
(Polietileno)
Floor tapestry
(Polythene)
Tapis de sol en feutre
(Polyéthylène)
Telo di protezione
(Polietilene)

dream pool serie

CÓRCEGA



KITPROV618PO



EAN 13

	730x375 cm	610x375 cm	500x300 cm
KITPROV738PO	730x375 cm	610x375 cm	500x300 cm
KITPROV618PO	132 cm	132 cm	132 cm
KITPROV508PO	28.217 l	23.281 l	16.210 l
	335 kg	270 kg	260 kg
	1/120x80	1/90x80	1/90x80
	5m ³ /h	5m ³ /h	5m ³ /h
	√	√	√
	√	√	√
	15	15	15
	12	12	12
	8 412081 264516	8 412081 264523	8 412081 264547

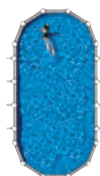
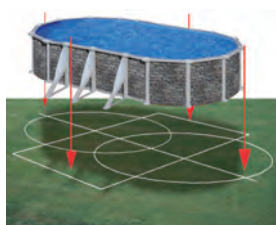

MEDIDA PISCINA
POOL SIZE
DIMENSIONS PISCINE
MISURA PISCINA

ESPACIO NECESARIO
NECESSARY SPACE
ESPACE NECESSAIRE
SPAZIO NECESSARIO

KITPROV738PO	730x375 cm	770x595 cm
KITPROV618PO	610x375 cm	650x595 cm
KITPROV508PO	500x300 cm	540x520 cm



Liner PVC azul
40/100
PVC blue liner
40/100
Liner PVC bleu
40/100
Liner PVC blu
40/100



Protectores de
inyección
Injection saver
Protections moulées
par injection
Angolare di
protezione



Perfilería de acero
Steel profiles
Poteaux et margelles
acier
Profili in acciaio



KITPR558PO



EAN 13

	Ø	H	V	P	Paquete	Filtración	Escalera	Cubierta	Pelotas	Altura	Altura	Barcode
KITPR558PO	Ø550 cm	132 cm	27.798 l	243 kg	1/90x80	5m ³ /h	✓	✓	15	12	8 412081 264530	
KITPR458PO	Ø460 cm	132 cm	19.444 l	238 kg	1/90x80	5m ³ /h	✓	✓	15	12	8 412081 264554	
KITPR358PO	Ø350 cm	132 cm	11.250 l	184 kg	1/90x80	5m ³ /h	✓	✓	15	12	8 412081 264561	

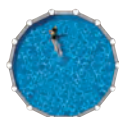

	MEDIDA PISCINA POOL SIZE DIMENSIONS PISCINE MISURA PISCINA	ESPACIO NECESARIO NECESSARY SPACE ESPACE NECESSAIRE SPAZIO NECESSARIO
KITPR558PO	Ø 550cm	600x600 cm
KITPR458PO	Ø 460cm	500x500 cm
KITPR358PO	Ø 350cm	400x400 cm



Depuradora arena
(Caudal grupo 5 m³/h)
Sand filter
(Flow group 5 m³/h)
Filtre à sable
(Débit groupe 5 m³/h)
Filtro a sabbia
(Portata gruppo 5 m³/h)



Escalera de seguridad
Plataforma +2x3 Peldaños
Safety Ladder
Platform + 2x3 Steps
Échelle sécurité
Plateforme + 2x3 Marches
Scala di sicurezza
Piattaforma + 2x3 Gradini

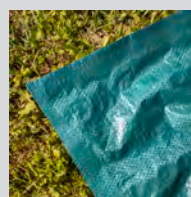

Tapiz protector
(Poliétileno)
Floor tapestry
(Polythene)
Tapis de sol en feutre
(Polyéthylène)
Telo di protezione
(Poliétilene)

dream pool serie CERDEÑA



KIT610PO



EAN 13

Model	Dimensions (cm)	Height (cm)	Capacity (l)	Weight (kg)	Box Size (cm)	Flow Rate (m³/h)	Accessories	Height (cm)	Width (cm)	Barcode
KIT730PO	730x375	120	25.323	287	1/90x80	4m³/h	√	15	12	8 4 1 2 0 8 1 2 6 4 5 7 8
KIT610PO	610x375	120	20.893	235	1/80x60	3m³/h	√	15	12	8 4 1 2 0 8 1 2 6 4 5 8 5
KIT500PO	500x300	120	14.550	224	1/80x60	3m³/h	√	15	12	8 4 1 2 0 8 1 2 6 4 5 9 2

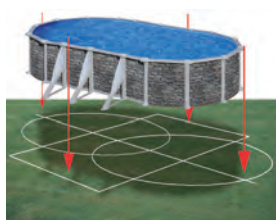

MEDIDA PISCINA
POOL SIZE
DIMENSIONS PISCINE
MISURA PISCINA

ESPACIO NECESARIO
NECESSARY SPACE
ESPACE NECESSAIRE
SPAZIO NECESSARIO

Model	Dimensions (cm)	Necessary Space (cm)
KIT730PO	730x375	770x595
KIT610PO	610x375	650x595
KIT500PO	500x300	540x520



Liner PVC azul 30/100
KIT730P/KIT610P: 40/100
PVC blue liner 30/100
KIT730P/KIT610P: 40/100
Liner PVC bleu 30/100
KIT730P/KIT610P: 40/100
Liner PVC blu 30/100
KIT730P/KIT610P: 40/100



Protectores de inyección
Injection saver
Protections moulées par injection
Angolare di protezione



Perfilería de acero
Steel profiles
Poteaux et margelles acier
Profili in acciaio



KIT350PO



EAN 13

	Ø	Height	Capacity	Weight	Size	Flow	✓	Steps	Depth	Barcode
KIT460PO	Ø460 cm	120 cm	17.450 l	172 kg	1/80x60	3m³/h	✓	15	12	8 412081 264608
KIT350PO	Ø350 cm	120 cm	10.102 l	146 kg	1/80x60	3m³/h	✓	15	12	8 412081 264615
KIT240PO	Ø240 cm	120 cm	4.750 l	126 kg	1/80x60	3m³/h	✓	15	12	8 412081 264622

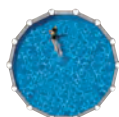

MEDIDA PISCINA
POOL SIZE
DIMENSIONS PISCINE
MISURA PISCINA

ESPACIO NECESARIO
NECESSARY SPACE
ESPACE NECESSAIRE
SPAZIO NECESSARIO

KIT460PO	Ø 460cm	500x500 cm
KIT350PO	Ø 350cm	400x400 cm
KIT240PO	Ø 240cm	300x300 cm



Depuradora arena
(Caudal grupo 3/4 m³/h)
Sand filter
(Flow group 3/4 m³/h)
Filtre à sable
(Débit groupe 3/4 m³/h)
Filtro a sabbia
(Portata gruppo 3/4 m³/h)

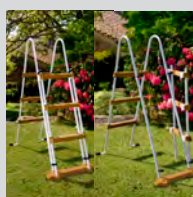

Escalera de seguridad
2x3 Peldaños
Safety Ladder
2x3 Steps
Échelle sécurité
2x3 Marches
Scala di sicurezza
2x3 Gradini

dream pool serie

AMAZONIA



KITPROV6188WO



EAN 13

Model	Dimensions (LxW)	Depth	Volume	Weight	Box Size	Flow Rate	Filter	Ladder	Accessories	Assembly	Barcode
KITPROV7388WO	730x375 cm	132 cm	28.217 l	348 kg	1/120x80	5m³/h	√	√	15	12	8 412081 257334
KITPROV6188WO	610x375 cm	132 cm	23.281 l	279 kg	1/90x80	5m³/h	√	√	15	12	8 412081 257341



MEDIDA PISCINA
POOL SIZE
DIMENSIONS PISCINE
MISURA PISCINA

ESPACIO NECESARIO
NECESSARY SPACE
ESPACE NECESSAIRE
SPAZIO NECESSARIO

KITPROV7388WO	730x375 cm	770x495 cm
KITPROV6188WO	610x375 cm	650x495 cm



Liner PVC azul
40/100
PVC blue liner
40/100
Liner PVC bleu
40/100
Liner PVC blu
40/100

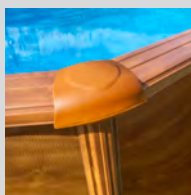

Protectores de
inyección
Injection saver
Protections moulées
par injection
Angolare di
protezione

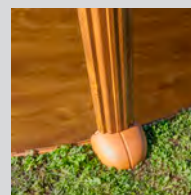

Perfilería de acero
Steel profiles
Poteaux et margelles
acier
Profili in acciaio



Viga de acero enterrada de 15x15 cm que hace innecesarios los postes exteriores, obteniendo mejor aprovechamiento del jardín.

15x15 cm buried steel beam makes unnecessary the outer buttress, optimizing the use of the garden area.

Poteaux en acier à enterrer de 15x15 cm évitant des renforts apparents extérieurs, pour mieux profiter de l'espace du jardin.

Barra di acciaio interrata da 15x15 cm che non rende necessario l'utilizzo delle barre laterali; permette di poter sfruttare al meglio gli spazi del proprio giardino.



Sistema de omegas Omega system Renforts enterrés Sistema omega



Depuradora arena
(Caudal grupo 5 m³/h)
Sand filter
(Flow group 5 m³/h)
Filtre à sable
(Débit groupe 5 m³/h)
Filtro a sabbia
(Portata gruppo 5 m³/h)



Escalera de seguridad
Plataforma +2x3 Peldaños
Safety Ladder
Platform + 2x3 Steps
Échelle sécurité
Plateforme + 2x3 Marches
Scala di sicurezza
Piattaforma + 2x3 Gradini

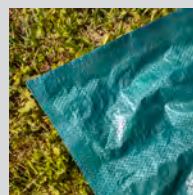

Tapiz protector
(Polietileno)
Floor tapestry
(Polythene)
Tapis de sol en feutre
(Polyéthylène)
Telo di protezione
(Polietilene)

dream pool serie

MAURITIUS



KITPROV738WO



EAN 13

Model	Dimensions (cm)	Height (cm)	Capacity (l)	Weight (kg)	Box Size (cm)	Flow Rate (m³/h)	Accessories	Accessories	Accessories	Accessories	Accessories	Accessories	Accessories	Accessories	Accessories	Accessories	Accessories	Accessories					
KITPROV738WO	730x375 cm	132 cm	28.217 l	335 kg	1/120x80	5m³/h	√	√	15	12	8	4	1	2	0	8	1	2	5	7	3	5	8
KITPROV618WO	610x375 cm	132 cm	23.281 l	270 kg	1/90x80	5m³/h	√	√	15	12	8	4	1	2	0	8	1	2	5	7	3	6	5
KITPROV508WO	500x300 cm	132 cm	16.210 l	260 kg	1/90x80	5m³/h	√	√	15	12	8	4	1	2	0	8	1	2	5	8	0	8	9

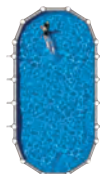

MEDIDA PISCINA
POOL SIZE
DIMENSIONS PISCINE
MISURA PISCINA

ESPACIO NECESARIO
NECESSARY SPACE
ESPACE NECESSAIRE
SPAZIO NECESSARIO

KITPROV738WO	730x375 cm	770x595 cm
KITPROV618WO	610x375 cm	650x595 cm
KITPROV508WO	500x300 cm	540x520 cm



Liner PVC azul
40/100
PVC blue liner
40/100
Liner PVC bleu
40/100
Liner PVC blu
40/100

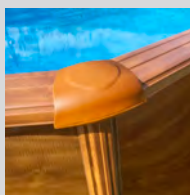

Protectores de
inyección
Injection saver
Protections moulées
par injection
Angolare di
protezione

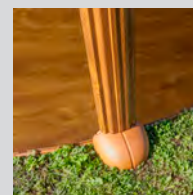

Perfilería de acero
Steel profiles
Poteaux et margelles
acier
Profili in acciaio



KITPR558WO



EAN 13

	Ø	Height	Capacity	Weight	Box Size	Flow Rate	✓	✓	Steps	Height	Barcode
KITPR558WO	Ø550 cm	132 cm	27.798 l	243 kg	1/90x80	5m³/h	✓	✓	15	12	8 412081 257372
KITPR458WO	Ø460 cm	132 cm	19.444 l	238 kg	1/90x80	5m³/h	✓	✓	15	12	8 412081 257389
KITPR358WO	Ø350 cm	132 cm	11.250 l	184 kg	1/90x80	5m³/h	✓	✓	15	12	8 412081 257396

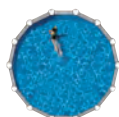

MEDIDA PISCINA
POOL SIZE
DIMENSIONS PISCINE
MISURA PISCINA

ESPACIO NECESARIO
NECESSARY SPACE
ESPACE NECESSAIRE
SPAZIO NECESSARIO

KITPR558WO	Ø 550cm	600x600 cm
KITPR458WO	Ø 460cm	500x500 cm
KITPR358WO	Ø 350cm	400x400 cm



Depuradora arena
(Caudal grupo 5 m³/h)
Sand filter
(Flow group 5 m³/h)
Filtre à sable
(Débit groupe 5 m³/h)
Filtro a sabbia
(Portata gruppo 5 m³/h)



Escalera de seguridad
Plataforma +2x3 Peldaños
Safety Ladder
Platform + 2x3 Steps
Plateforme + 2x3 Marches
Échelle sécurité
Plateforme + 2x3 Marches
Scala di sicurezza
Piattaforma + 2x3 Gradini

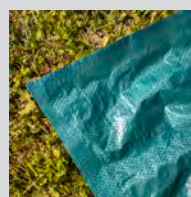

Tapiz protector
(Poliétileno)
Floor tapestry
(Polythene)
Tapis de sol en feutre
(Polyéthylène)
Telo di protezione
(Poliétileno)

dream pool serie **MALDIVAS**



KITPROV5083W



EAN 13

KITPROV5083W

500x300 cm

132 cm

16.210 l

217 kg

1/90x80

3,8m³/h

√

15

12

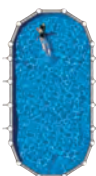

MEDIDA PISCINA
POOL SIZE
DIMENSIONS PISCINE
MISURA PISCINA

ESPACIO NECESARIO
NECESSARY SPACE
ESPACE NECESSAIRE
SPAZIO NECESSARIO

KITPROV5083W

500x300 cm

540x520 cm



Liner PVC azul
40/100
PVC blue liner
40/100
Liner PVC bleu
40/100
Liner PVC blu
40/100

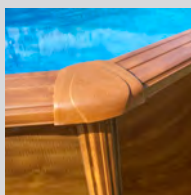

Protectores de
inyección
Injection saver
Protections moulées
par injection
Angolare di
protezione

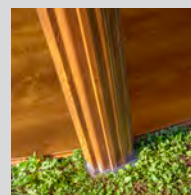

Perfilería de acero
Steel profiles
Poteaux et margelles
acier
Profili in acciaio



KITPR4583W



EAN 13

	Ø	Height	Capacity	Weight	Box Size	Flow Rate	✓	Platform	Steps	Barcode
KITPR4583W	Ø460 cm	132 cm	19.444 l	167 kg	1/80x40	3,8m³/h	✓	15	12	8 4 1 2 0 8 1 2 5 8 0 5 8
KITPR3583W	Ø350 cm	132 cm	11.250 l	156 kg	1/80x40	3,8m³/h	✓	15	12	8 4 1 2 0 8 1 2 5 8 0 6 5

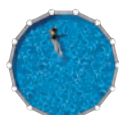

MEDIDA PISCINA
POOL SIZE
DIMENSIONS PISCINE
MISURA PISCINA

ESPACIO NECESARIO
NECESSARY SPACE
ESPACE NECESSAIRE
SPAZIO NECESSARIO

KITPR4583W

Ø 460cm

500x500 cm

KITPR3583W

Ø 350cm

400x400 cm

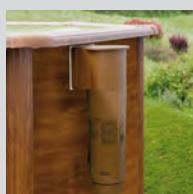

Filtro de cartucho
(3,8 m³/h)
Cartidge filter
(3,8 m³/h)
Filtre à cartouche
(3,8 m³/h)
Filtro a cartuccia
(3,8 m³/h)



Escalera de seguridad
Plataforma +2x3 Peldaños
Safety Ladder
Platform + 2x3 Steps
Échelle sécurité
Plateforme + 2x3 Marches
Scala di sicurezza
Piattaforma + 2x3 Gradini

dream pool serie PACIFIC



KIT730W



EAN 13

Model	Dimensions (LxW)	Height	Capacity (l)	Weight (kg)	Box Size (LxW)	Flow Rate (m³/h)	Accessories	Steps	Accessories	Barcode
KIT730W	730x375 cm	120 cm	25.323 l	287 kg	1/90x80	4m³/h	√	15	12	8 4 1 2 0 8 1 2 3 2 2 4 9
KIT610W	610x375 cm	120 cm	20.893 l	235 kg	1/80x60	3m³/h	√	15	12	8 4 1 2 0 8 1 2 2 5 1 0 4
KIT500W	500x300 cm	120 cm	14.550 l	224 kg	1/80x60	3m³/h	√	15	12	8 4 1 2 0 8 1 2 3 1 0 6 8



MEDIDA PISCINA
POOL SIZE
DIMENSIONS PISCINE
MISURA PISCINA

ESPACIO NECESARIO
NECESSARY SPACE
ESPACE NECESSAIRE
SPAZIO NECESSARIO

Model	Pool Size (LxW)	Necessary Space (LxW)
KIT730W	730x375 cm	770x595 cm
KIT610W	610x375 cm	650x595 cm
KIT500W	500x300 cm	540x520 cm



Liner PVC azul
40/100
PVC blue liner
40/100
Liner PVC bleu
40/100
Liner PVC blu
40/100
KIT500/460/350/240W: 30/100

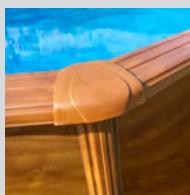

Protectores de
inyección
Injection saver
Protections moulées
par injection
Angolare di
protezione

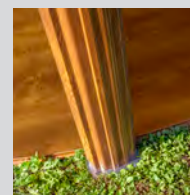

Perfilería de acero
Steel profiles
Poteaux et margelles
acier
Profili in acciaio



KIT460W



EAN 13

	Ø	Height	Capacity	Weight	Box Size	Flow	✓	Steps	Material	Barcode
KIT460W	Ø460 cm	120 cm	17.450 l	172 kg	1/80x60	3m³/h	✓	15	12	8 4 12081 225111
KIT350W	Ø350 cm	120 cm	10.102 l	146 kg	1/80x60	3m³/h	✓	15	12	8 4 12081 225722
KIT240W	Ø240 cm	120 cm	4.750 l	126 kg	1/80x60	3m³/h	✓	15	12	8 4 12081 226163

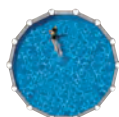

MEDIDA PISCINA
POOL SIZE
DIMENSIONS PISCINE
MISURA PISCINA

ESPACIO NECESARIO
NECESSARY SPACE
ESPACE NECESSAIRE
SPAZIO NECESSARIO

	Pool Size	Necessary Space
KIT460W	Ø 460cm	500x500 cm
KIT350W	Ø 350cm	400x400 cm
KIT240W	Ø 240cm	300x300 cm



Depuradora arena
(Caudal grupo 3/4 m³/h)
Sand filter
(Flow group 3/4 m³/h)
Filtre à sable
(Débit groupe 3/4 m³/h)
Filtro a sabbia
(Portata gruppo 3/4 m³/h)

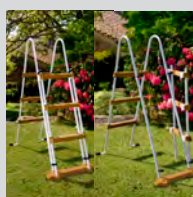

Escalera de seguridad
2x3 Peldaños
Safety Ladder
2x3 Steps
Échelle sécurité
2x3 Marches
Scala di sicurezza
2x3 Gradini

dream pool serie

SICILIA



KITPROV503W



EAN 13

KITPROV503W

500x300 cm

120 cm

14.550 l

205 kg

1/80x60

3,8m³/h

√

15

12

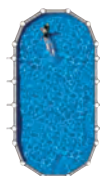

MEDIDA PISCINA
POOL SIZE
DIMENSIONS PISCINE
MISURA PISCINA

ESPACIO NECESARIO
NECESSARY SPACE
ESPACE NECESSAIRE
SPAZIO NECESSARIO

KITPROV503W

500x300 cm

540x520 cm



Liner PVC azul
30/100
PVC blue liner
30/100
Liner PVC bleu
30/100
Liner PVC blu
30/100

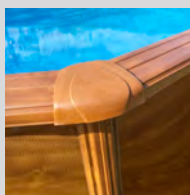

Protectores de
inyección
Injection saver
Protections moulées
par injection
Angolare di
protezione

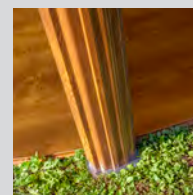

Perfilería de acero
Steel profiles
Poteaux et margelles
acier
Profili in acciaio



KITPR453W



EAN 13

Model	Ø	Height	Capacity	Weight	Box Size	Flow Rate	✓	Accessories	Accessories	Barcode
KITPR453W	Ø460 cm	120 cm	17.450 l	149 kg	3/120x80	3,8m³/h	✓	15	12	8 412081 258171
KITPR353W	Ø350 cm	120 cm	10.102 l	109 kg	3/120x80	3,8m³/h	✓	15	12	8 412081 258188
KITPR303W	Ø300 cm	120 cm	7.418 l	94 kg	3/120x80	3,8m³/h	✓	15	12	8 412081 265087

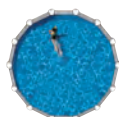

MEDIDA PISCINA
POOL SIZE
DIMENSIONS PISCINE
MISURA PISCINA

ESPACIO NECESARIO
NECESSARY SPACE
ESPACE NECESSAIRE
SPAZIO NECESSARIO

KITPR453W	Ø 460cm	500x500 cm
KITPR353W	Ø 350cm	400x400 cm
KITPR303W	Ø 300cm	350x350 cm

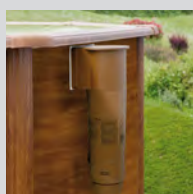

Filtro de cartucho
(3,8 m³/h)
Cartidge filter
(3,8 m³/h)
Filtre à cartouche
(3,8 m³/h)
Filtro a cartuccia
(3,8 m³/h)

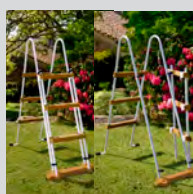

Escalera de seguridad
2x3 Peldaños
Safety Ladder
2x3 Steps
Échelle sécurité
2x3 Marches
Scala di sicurezza
2x3 Gradini

dream pool serie

HAITI



KITPROV9188



EAN 13

	1000x550 cm	915x470 cm	800x470 cm	730x375 cm	610x375 cm
KITPROV10288	1000x550 cm	915x470 cm	800x470 cm	730x375 cm	610x375 cm
KITPROV9188	1000x550 cm	915x470 cm	800x470 cm	730x375 cm	610x375 cm
KITPROV8188	1000x550 cm	915x470 cm	800x470 cm	730x375 cm	610x375 cm
KITPROV7388	1000x550 cm	915x470 cm	800x470 cm	730x375 cm	610x375 cm
KITPROV6188	1000x550 cm	915x470 cm	800x470 cm	730x375 cm	610x375 cm

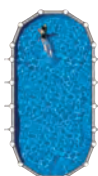
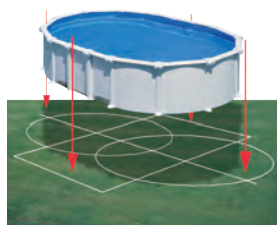

MEDIDA PISCINA
POOL SIZE
DIMENSIONS PISCINE
MISURA PISCINA

ESPACIO NECESARIO
NECESSARY SPACE
ESPACE NECESSAIRE
SPAZIO NECESSARIO

KITPROV10288	1000x550 cm	1040x670 cm
KITPROV9188	915x470 cm	955x590 cm
KITPROV8188	800x470 cm	850x590 cm
KITPROV7388	730x375 cm	770x495 cm
KITPROV6188	610x375 cm	650x495 cm



Liner PVC azul
40/100
PVC blue liner
40/100
Liner PVC bleu
40/100
Liner PVC blu
40/100



Protectores de
inyección
Injection saver
Protections moulées
par injection
Angolare di
protezione



Perfilería de acero
Steel profiles
Poteaux et margelles
acier
Profili in acciaio



Viga de acero enterrada de 15x15 cm que hace innecesarios los postes exteriores, obteniendo mejor aprovechamiento del jardín.

15x15 cm buried steel beam makes unnecessary the outer buttress, optimizing the use of the garden area.

Poteaux en acier à enterrer de 15x15 cm évitant des renforts apparents extérieurs, pour mieux profiter de l'espace du jardin.

Barra di acciaio interrata da 15x15 cm che non rende necessario l'utilizzo delle barre laterali; permette di poter sfruttare al meglio gli spazi del proprio giardino.



Sistema de omegas Omega system Renforts enterrés Sistema omega



Depuradora arena
(Caudal grupo 10/8/7/5 m³/h)
Sand filter
(Flow group 10/8/7/5 m³/h)
Filtre à sable
(Débit groupe 10/8/7/5 m³/h)
Filtro a sabbia
(Portata gruppo 10/8/7/5 m³/h)



Escalera de seguridad
Plataforma +2x3 Peldaños
Safety Ladder
Platform + 2x3 Steps
Échelle sécurité
Plateforme + 2x3 Marches
Scala di sicurezza
Piattaforma + 2x3 Gradini

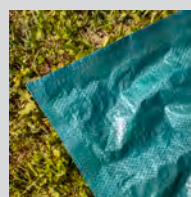

Tapiz protector
(Polietileno)
Floor tapestry
(Polythene)
Tapis de sol en feutre
(Polyéthylène)
Telo di protezione
(Polietilene)

dream pool serie

ATLANTIS



KITPROV918



EAN 13

	1000x550 cm	915x470 cm	800x470 cm	730x375 cm	610x375 cm	500x300 cm
KITPROV1028	1000x550 cm	915x470 cm	800x470 cm	730x375 cm	610x375 cm	500x300 cm
KITPROV918	1000x550 cm	915x470 cm	800x470 cm	730x375 cm	610x375 cm	500x300 cm
KITPROV818	1000x550 cm	915x470 cm	800x470 cm	730x375 cm	610x375 cm	500x300 cm
KITPROV738	1000x550 cm	915x470 cm	800x470 cm	730x375 cm	610x375 cm	500x300 cm
KITPROV618	1000x550 cm	915x470 cm	800x470 cm	730x375 cm	610x375 cm	500x300 cm
KITPROV508	1000x550 cm	915x470 cm	800x470 cm	730x375 cm	610x375 cm	500x300 cm

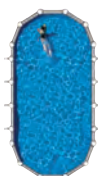
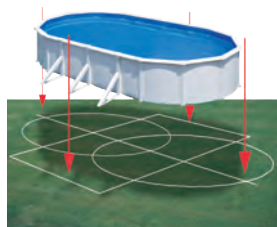

	MEDIDA PISCINA POOL SIZE DIMENSIONS PISCINE MISURA PISCINA	ESPACIO NECESARIO NECESSARY SPACE ESPACE NECESSAIRE SPAZIO NECESSARIO
KITPROV1028	1000x550 cm	1040x770 cm
KITPROV918	915x470 cm	955x690 cm
KITPROV818	800x470 cm	850x690 cm
KITPROV738	730x375 cm	770x595 cm
KITPROV618	610x375 cm	650x595 cm
KITPROV508	500x300 cm	540x520 cm



Liner PVC azul
40/100
PVC blue liner
40/100
Liner PVC bleu
40/100
Liner PVC blu
40/100



Protectores de
inyección
Injection saver
Protections moulées
par injection
Angolare di
protezione



Perfilería de acero
Steel profiles
Poteaux et margelles
acier
Profili in acciaio



KITPR558



EAN 13

Model	Ø	Height	Capacity (l)	Weight (kg)	Volume (m³)	Flow (m³/h)	Filter	Ladder	Mat	Tapestry	Barcode
KITPR558	Ø550 cm	132 cm	27.798 l	243 kg	1/90x80	5m³/h	√	√	15	12	8 412081 211589
KITPR458	Ø460 cm	132 cm	19.444 l	238 kg	1/90x80	5m³/h	√	√	15	12	8 412081 211596
KITPR358	Ø350 cm	132 cm	11.250 l	184 kg	1/90x80	5m³/h	√	√	15	12	8 412081 233864

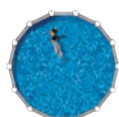
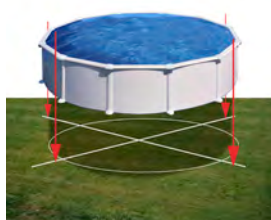

	MEDIDA PISCINA POOL SIZE DIMENSIONS PISCINE MISURA PISCINA	ESPACIO NECESARIO NECESSARY SPACE ESPACE NECESSAIRE SPAZIO NECESSARIO
KITPR558	Ø 550cm	600x600 cm
KITPR458	Ø 460cm	500x500 cm
KITPR358	Ø 350cm	400x400 cm



Depuradora arena
(Caudal grupo 10/8/7/5 m³/h)
Sand filter
(Flow group 10/8/7/5 m³/h)
Filtre à sable
(Débit groupe 10/8/7/5 m³/h)
Filtro a sabbia
(Portata gruppo 10/8/7/5 m³/h)



Escalera de seguridad
Plataforma +2x3 Peldaños
Safety Ladder
Platform + 2x3 Steps
Échelle sécurité
Plateforme + 2x3 Marches
Scala di sicurezza
Piattaforma + 2x3 Gradini



Tapiz protector
(Polietileno)
Floor tapestry
(Polythene)
Tapis de sol en feutre
(Polyéthylène)
Telo di protezione
(Polietilene)

dream pool serie **AZORES**



KITPROV5083



EAN 13

KITPROV5083

500x300 cm

132 cm

16.210 l

217 kg

1/90x80

3,8m³/h

√

15

12

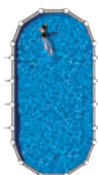
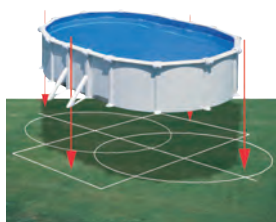

MEDIDA PISCINA
POOL SIZE
DIMENSIONS PISCINE
MISURA PISCINA

ESPACIO NECESARIO
NECESSARY SPACE
ESPACE NECESSAIRE
SPAZIO NECESSARIO

KITPROV5083

500x300 cm

540x520 cm



Liner PVC azul
40/100
PVC blue liner
40/100
Liner PVC bleu
40/100
Liner PVC blu
40/100



Protectores de
inyección
Injection saver
Protections moulées
par injection
Angolare di
protezione



Perfilería de acero
Steel profiles
Poteaux et margelles
acier
Profili in acciaio



KITPR4583



EAN 13

	Ø	Height	Volume	Weight	Box Size	Flow Rate	✓	Platform	Steps	Barcode
KITPR4583	Ø460 cm	132 cm	19.444 l	167 kg	1/80x40	3,8m³/h	✓	15	12	8 4 12081 258027
KITPR3583	Ø350 cm	132 cm	11.250 l	156 kg	1/80x40	3,8m³/h	✓	15	12	8 4 12081 258034

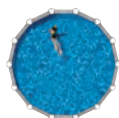
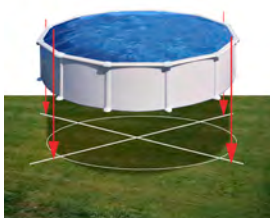

	MEDIDA PISCINA POOL SIZE DIMENSIONS PISCINE MISURA PISCINA	ESPACIO NECESARIO NECESSARY SPACE ESPACE NECESSAIRE SPAZIO NECESSARIO
KITPR4583	Ø 460cm	500x500 cm
KITPR3583	Ø 350cm	400x400 cm



Filtro de cartucho
(3,8 m³/h)
Cartidge filter
(3,8 m³/h)
Filtre à cartouche
(3,8 m³/h)
Filtro a cartuccia
(3,8 m³/h)



Escalera de seguridad
Plataforma +2x3 Peldaños
Safety Ladder
Platform + 2x3 Steps
Échelle sécurité
Plateforme + 2x3 Marches
Scala di sicurezza
Piattaforma + 2x3 Gradini

dream pool serie **FIDJI**



KIT730ECO



EAN 13

	800x470 cm	730x375 cm	610x375 cm	500x300 cm
KIT810ECO	800x470 cm	730x375 cm	610x375 cm	500x300 cm
KIT730ECO	120 cm	120 cm	120 cm	120 cm
KIT610ECO	33.630 l	25.323 l	20.893 l	14.550 l
KIT500ECO	298 kg	287 kg	235 kg	224 kg
	1/90x80	1/90x80	1/80x60	1/80x60
	5m³/h	4m³/h	3m³/h	3m³/h
	√	√	√	√
	15	15	15	15
	12	12	12	12
	8 412081 266350	8 412081 211398	8 412081 211404	8 412081 231037

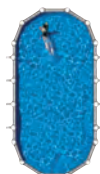
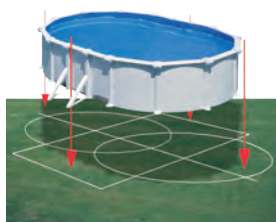

MEDIDA PISCINA
POOL SIZE
DIMENSIONS PISCINE
MISURA PISCINA

ESPACIO NECESARIO
NECESSARY SPACE
ESPACE NECESSAIRE
SPAZIO NECESSARIO

	MEDIDA PISCINA POOL SIZE DIMENSIONS PISCINE MISURA PISCINA	ESPACIO NECESARIO NECESSARY SPACE ESPACE NECESSAIRE SPAZIO NECESSARIO
KIT810ECO	800x470 cm	850x690 cm
KIT730ECO	730x375 cm	770x595 cm
KIT610ECO	610x375 cm	650x595 cm
KIT500ECO	500x300 cm	540x520 cm

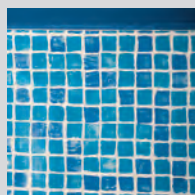

KIT810ECO Liner PVC
gresite 50/100
KIT810ECO PVC
ceramics liner 50/100
KIT810ECO Liner PVC
carrelage 50/100
KIT810ECO Liner PVC
mosaicato 50/100



Liner PVC azul 30/100
KIT730/KIT610: 40/100
PVC blue liner 30/100
KIT730/KIT610: 40/100
Liner PVC bleu 30/100
KIT730/KIT610: 40/100
Liner PVC blu 30/100
KIT730/KIT610: 40/100



Protectores de
inyección
Injection saver
Protections moulées
par injection
Angolare di
protezione



KIT460ECO



EAN 13

Model	Ø	Height	Volume	Weight	Box Size	Flow	✓	Steps	Height	Barcode
KIT550ECO	Ø550 cm	120 cm	24.944 l	209 kg	1/80x60	4m³/h	✓	15	12	8 4 120 81 2 114 11
KIT460ECO	Ø460 cm	120 cm	17.450 l	172 kg	1/80x60	3m³/h	✓	15	12	8 4 120 81 2 114 28
KIT350ECO	Ø350 cm	120 cm	10.102 l	146 kg	1/80x60	3m³/h	✓	15	12	8 4 120 81 2 114 35
KIT300ECO	Ø300 cm	120 cm	7.418 l	136 kg	1/80x60	3m³/h	✓	15	12	8 4 120 81 2 287 54
KIT240ECO	Ø240 cm	120 cm	4.750 l	120 kg	1/80x60	3m³/h	✓	15	12	8 4 120 81 2 408 31

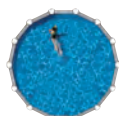
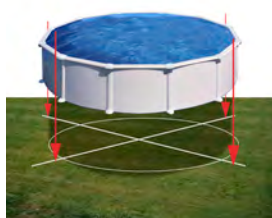

MEDIDA PISCINA
POOL SIZE
DIMENSIONS PISCINE
MISURA PISCINA

ESPACIO NECESARIO
NECESSARY SPACE
ESPACE NECESSAIRE
SPAZIO NECESSARIO

Model	Ø	Required Space
KIT550ECO	Ø 550 cm	600x600 cm
KIT460ECO	Ø 460 cm	500x500 cm
KIT350ECO	Ø 350 cm	400x400 cm
KIT300ECO	Ø 300 cm	350x350 cm
KIT240ECO	Ø 240 cm	300x300 cm



Perfilería de acero
Steel profiles
Poteaux et margelles
acier
Profili in acciaio

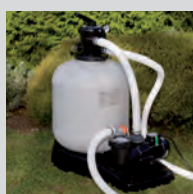

Depuradora arena
(Caudal grupo 3/4/5 m³/h)
Sand filter
(Flow group 3/4/5 m³/h)
Filtre à sable
(Débit groupe 3/4/5 m³/h)
Filtro a sabbia
(Portata gruppo 3/4/ 5 m³/h)

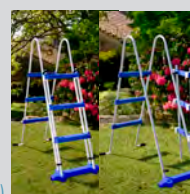

Escalera de seguridad
2x3 Peldaños
Safety Ladder
2x3 Steps
Échelle sécurité
2x3 Marches
Scala di sicurezza
2x3 Gradini

dream pool serie

VARADERO



KITPROV7070



EAN 13

	710x475 cm	120 cm	27.872 l	371 kg	1/90x80	4m ³ /h	√	√	15	12	8 4 1 2 0 8 1 2 1 1 6 2 6
KITPROV7070	710x475 cm	120 cm	27.872 l	371 kg	1/90x80	4m ³ /h	√	√	15	12	
KITPROV6270	640x390 cm	120 cm	20.652 l	311 kg	1/90x80	4m ³ /h	√	√	15	12	
KITPROV4870	500x340 cm	120 cm	13.696 l	284 kg	1/90x80	4m ³ /h	√	√	15	12	

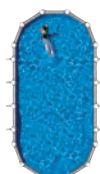
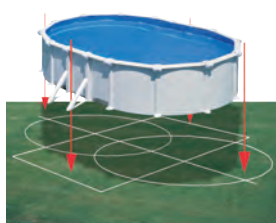

MEDIDA PISCINA
POOL SIZE
DIMENSIONS PISCINE
MISURA PISCINA

ESPACIO NECESARIO
NECESSARY SPACE
ESPACE NECESSAIRE
SPAZIO NECESSARIO

KITPROV7070	710x475 cm	755x510 cm
KITPROV6270	640x390 cm	700x430 cm
KITPROV4870	500x340 cm	540x380 cm



Liner PVC azul
40/100
PVC blue liner
40/100
Liner PVC bleu
40/100
Liner PVC blu
40/100



Protectores de
inyección
Injection saver
Protections moulées
par injection
Angolare di
protezione

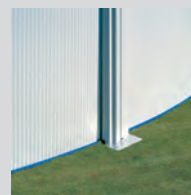

Perfilería de acero
Steel profiles
Poteaux et margelles
acier
Profili in acciaio



Viga de acero enterrada de 15x15 cm que hace innecesarios los postes exteriores, obteniendo mejor aprovechamiento del jardín.

15x15 cm buried steel beam makes unnecessary the outer buttress, optimizing the use of the garden area.

Poteaux en acier à enterrer de 15x15 cm évitant des renforts apparents extérieurs, pour mieux profiter de l'espace du jardin.

Barra di acciaio interrata da 15x15 cm che non rende necessario l'utilizzo delle barre laterali; permette di poter sfruttare al meglio gli spazi del proprio giardino.



Sistema de omegas Omega system Renforts enterrés Sistema omega



Depuradora arena
(Caudal grupo 4 m³/h)
Sand filter
(Flow group 4 m³/h)
Filtre à sable
(Débit groupe 4 m³/h)
Filtro a sabbia
(Portata gruppo 4 m³/h)

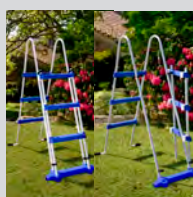

Escalera de seguridad
2x3 Peldaños
Safety Ladder
2x3 Steps
Échelle sécurité
2x3 Marches
Scala di sicurezza
2x3 Gradini

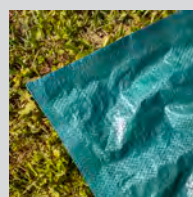

Tapiz protector
(Poliétileno)
Floor tapestry
(Polythene)
Tapis de sol en feutre
(Polyéthylène)
Telo di protezione
(Poliétilene)

dream pool serie

BORA BORA



KITPROV613



EAN 13

	610x375 cm	120 cm	20.893 l	210 kg	1/80x60	3,8m³/h	√	15	12	8 412081 220437
KITPROV613	610x375 cm	120 cm	20.893 l	210 kg	1/80x60	3,8m³/h	√	15	12	8 412081 220437
KITPROV503	500x300 cm	120 cm	14.550 l	205 kg	1/80x60	3,8m³/h	√	15	12	8 412081 220260

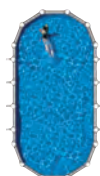
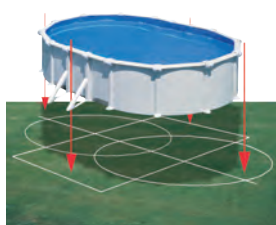

MEDIDA PISCINA
POOL SIZE
DIMENSIONS PISCINE
MISURA PISCINA

ESPACIO NECESARIO
NECESSARY SPACE
ESPACE NECESSAIRE
SPAZIO NECESSARIO

KITPROV613	610x375 cm	650x595 cm
KITPROV503	500x300 cm	540x520 cm



Liner PVC azul
40/100
PVC blue liner
40/100
Liner PVC bleu
40/100
Liner PVC blu
40/100
KITPROV503/KITPR453/353/303.30/100



Protectores de
inyección
Injection saver
Protections moulées
par injection
Angolare di
protezione

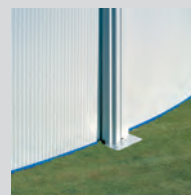

Perfilería de acero
Steel profiles
Poteaux et margelles
acier
Profili in acciaio



KITPR453



EAN 13

Model	Pool Diameter	Pool Height	Volume	Weight	Box Dimensions	Flow Rate	Filter	Steps	Height	Depth	Barcode
KITPR453	Ø460 cm	120 cm	17.450 l	149 kg	1/80x40	3,8m³/h	√	15	12	8 412081 209005	
KITPR353	Ø350 cm	120 cm	10.102 l	109 kg	1/80x40	3,8m³/h	√	15	12	8 412081 209012	
KITPR303	Ø300 cm	120 cm	7.418 l	94 kg	1/80x40	3,8m³/h	√	15	12	8 412081 233901	

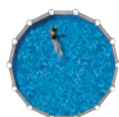
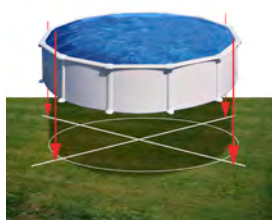

MEDIDA PISCINA
POOL SIZE
DIMENSIONS PISCINE
MISURA PISCINA

ESPACIO NECESARIO
NECESSARY SPACE
ESPACE NECESSAIRE
SPAZIO NECESSARIO

Model	Pool Diameter	Necessary Space
KITPR453	Ø 460 cm	500x500 cm
KITPR353	Ø 350 cm	400x400 cm
KITPR303	Ø 300 cm	350x350 cm



Filtro de cartucho
(3,8 m³/h)
Cartidge filter
(3,8 m³/h)
Filtre à cartouche
(3,8 m³/h)
Filtro a cartuccia
(3,8 m³/h)

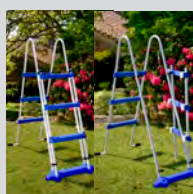

Escalera de seguridad
2x3 Peldaños
Safety Ladder
2x3 Steps
Échelle sécurité
2x3 Marches
Scala di sicurezza
2x3 Gradini

dream pool serie

LANZAROTE

KITWPR452E



EAN 13

	Ø	Height	Capacity	Weight	Box Size	Filter	✓	Step 1	Step 2	Barcode
KITWPR452E	Ø450 cm	90 cm	12.717 l	56 kg	8/120x80	2m³/h	✓	3,5	3,5	8 412081 241418
KITWPR352E	Ø350 cm	90 cm	7.693 l	47 kg	8/120x80	2m³/h	✓	3,5	3,5	8 412081 241401
KITWPR302	Ø300 cm	90 cm	6.358 l	44 kg	8/120x80	2m³/h	✓	3,5	3,5	8 412081 231044

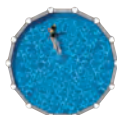
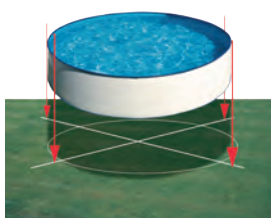

MEDIDA PISCINA
POOL SIZE
DIMENSIONS PISCINE
MISURA PISCINA

ESPACIO NECESARIO
NECESSARY SPACE
ESPACE NECESSAIRE
SPAZIO NECESSARIO

Model	Pool Diameter	Required Space
KITWPR452E	Ø 450 cm	500x500 cm
KITWPR352E	Ø 350 cm	400x400 cm
KITWPR302	Ø 300 cm	350x350 cm



Liner PVC azul
20/100
PVC blue liner
20/100
Liner PVC bleu
20/100
Liner PVC blu
20/100



Filtro de cartucho:
2 m³/h
Cartidge filter
2 m³/h
Filtre à cartouche
2 m³/h
Filtro a cartuccia
2 m³/h

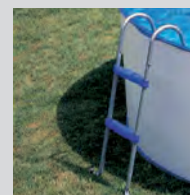

Escalera
2x2 Peldaños
Ladder
2x2 Steps
Échelle
2x2 Marches
Scala
2x2 Gradini

dream pool serie **TENERIFE**



KITWPR450E



EAN 13

	Ø	H	V	P	M	F	L	C	P	C
KITWPR450E	Ø450 cm	90 cm	12.717 l	56 kg	8/120x80	2m³/h	√	3,5	3,5	8 4 1 2 0 8 1 2 4 1 2 1 0
KITWPR350E	Ø350 cm	90 cm	7.693 l	47 kg	8/120x80	2m³/h	√	3,5	3,5	8 4 1 2 0 8 1 2 4 1 2 0 3

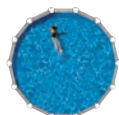
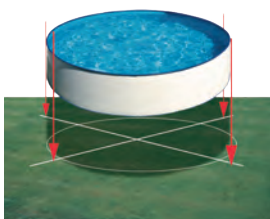

	MEDIDA PISCINA POOL SIZE DIMENSIONS PISCINE MISURA PISCINA	ESPACIO NECESARIO NECESSARY SPACE ESPACE NECESSAIRE SPAZIO NECESSARIO
KITWPR450E	Ø 450 cm	500x500 cm
KITWPR350E	Ø 350 cm	400x400 cm



Leyenda Legend Légende Legenda

BX

caja
box
box
scatola

BXL

caja con etiqueta
box and label
carton avec étiquette
scatola con etichetta

CB

cartoncillo
cardboard wrap
bande carton
cartone

CBX

caja litografiada
colour box
boîte de couleur
scatola serigrafata

PB

bolsa de plástico
polybag
sac plastique
busta di plastica

PBH

bolsa de plástico con cartoncillo
polybag with header
sac plastique avec bande carton
sacchetto di plastica con cartone

BL

blister
blister
blister
blister

CS

doble burbuja
clamshell
double coque
doppio rivestimento

DIS

display
display
display
display

complementos complements

COMPLEMENTOS	74	COMPLEMENTS
Cubiertas isotérmicas para piscinas de madera	76	Wooden pool isothermic covers
Cubiertas de invierno para piscinas de madera	77	Wooden pool winter covers
Cubiertas isotérmicas para piscinas de composite	78	Composite pool isothermic covers
Cubiertas de invierno para piscinas de composite	78	Composite pool winter covers
Cubiertas isotérmicas para piscinas enterrada	79	In ground pool isothermic covers
Cubiertas isotérmicas	80	Isothermic covers
Cubiertas de invierno	81	Winter covers
Mantas	82	Bottom protective blankets
Enrolladores de cubiertas	83	Telescopic cover rollers
Liners	85	Liners
Protectores	88	Protectors
Reparadores de liner	89	Liner repairs
Escaleras para piscinas enterradas	90	Inground pool ladders
Escaleras para piscina de madera	91	Wooden pool ladder
Escaleras para piscinas sobre suelo	92	Above-ground pool ladders
Monoblocs de filtración	94	Filtration kit
Bombas	96	Pumps
Cargas filtrantes	97	Filter media
Mangueras de filtración	98	Filtration hoses
Adaptadores	99	Adapters
Skimmers	100	Skimmers
Repuestos de filtración	100	Filtration spare parts
Filtros de Cartucho	103	Cartridge filter
Cartuchos	103	Cartridges
Tratamiento de agua	104	Water treatment
Electrolisis de sal	104	Electrolysis of salt
Sistemas de dosificación	106	Dosing systems
Seguridad piscina	107	Pool security
Iluminación	108	Lighting
Calefacción	112	Heating systems
Calefacción solar	113	Solar heating system
Duchas	114	Showers
Locales técnicos	118	Technical rooms
Racordería	118	PVC Fittings

complements complementi

COMPLEMENTS	74	COMPLEMENTI
Couvertures isothermes pour piscines bois	76	Coperture isothermiche per piscine in legno
Couvertures pour l'hiver pour piscines bois	77	Copertura invernale per piscine in legno
Couvertures isothermes pour piscines composite	78	Coperture isothermiche per piscine composite
Couvertures pour l'hiver pour piscines composite	78	Copertura invernale per piscine composite
Couvertures pour l'hiver pour piscines enterrée	79	Copertura invernale per piscine interrata
Couvertures isothermes	80	Coperture isothermiche
Couvertures pour l'hiver	81	Copertura invernale
Couvertures de protection du fond	82	Telo di protezione fondi
Enrouleurs de bâches	83	Avvolgitore
Liners	85	Liners
Protecteurs	88	Protezioni
Réparation liner	89	Riparazione liner
Échelles pour piscines enterrées	90	Scaletta per piscina interrata
Échelle pour piscines bois	91	Scaletta per piscina in legno
Échelles pour piscines hors sol	92	Scaletta per piscina fuori terra
Platine de filtration	94	Filtro monoblocco
Pompes	96	Pompe
Médias filtrants	97	Carico filtrante
Tuyaux por épurateurs	98	Tubi di filtraggio
Adaptateurs	99	Adattatori
Skimmers	100	Skimmers
Accessoires pour filtration	100	Filtraggio parti
Epurateur a cartouche	103	Filtri a cartuccia
Cartouches	103	Cartucce
Traitement d'eau	104	Trattamento acqua
Electrolyse de sel	104	Elettrolisi salina
Systemes de dosage	106	Sistemi di dosaggio
Protection pour piscine	107	Protezione per piscine
Éclairage	108	Illuminazione
Chauffage	112	Riscaldamento
Chauffage solaire	113	Riscaldamento solare
Douches	114	Docce
Local technique	118	Locale tecnico
Raccords PVC	118	Racorderia in PVC

CUBIERTAS ISOTÉRMICAS PARA PISCINAS DE MADERA **WOODEN POOL ISOTHERMIC COVERS** BÂCHES ÉTÉ POUR PISCINES BOIS **COPERTURE ISOTERMICHE PER PISCINE IN LEGNO**



EAN 13

NEW 786642	1152x352	400 μ	-	-	-	1200x400	-	BXL pack 1	
NEW 786641	952x352	400 μ	-	-	-	1000x400	-	BXL pack 1	
NEW 786640	852x252	400 μ	-	-	-	900x300	-	BXL pack 1	
788922	752x352	400 μ	-	-	-	800x400	-	BXL pack 1	
788921	552x352	400 μ	-	-	-	600x400	-	BXL pack 1	
NEW 788453	352x202	400 μ	-	-	-	400x250	-	BXL pack 1	
788920	267x267	400 μ	-	-	-	-	300x300	BXL pack 1	
786637	889x355	400 μ	942x592	-	-	-	-	BXL pack 1	
786636	818x518	400 μ	872x472	-	-	-	-	BXL pack 1	
786634	618x418	400 μ	672x472	-	-	-	-	BXL pack 1	
784800	585x360	400 μ	-	637x412	-	-	-	BXL pack 1	
779532	498x298	400 μ	-	551x351	-	-	-	BXL pack 1	
779530	398x298	400 μ	-	436x336	-	-	-	BXL pack 1	
784799	453 ø	400 μ	-	-	511 ø	-	-	BXL pack 1	
779524	355 ø	400 μ	-	-	412 ø	-	-	BXL pack 1	
NEW 787057	255 ø	400 μ	-	-	295 ø	-	-	BXL pack 1	

CUBIERTAS DE INVIERNO PARA PISCINAS DE MADERA **WOODEN POOL WINTER COVERS** BÂCHES HIVER POUR PISCINES BOIS **COPERTURE INVERNALE PER PISCINE IN LEGNO**



EAN 13

NEW 778042	1240x440	580 g/m ²	-	-	-	1200x400	-	BXL pack 1	3 605217 780423
NEW 778041	1040x440	580 g/m ²	-	-	-	1000x400	-	BXL pack 1	3 605217 780416
NEW 778040	940x340	580 g/m ²	-	-	-	900x300	-	BXL pack 1	3 605217 780409
788927	840x440	580 g/m ²	-	-	-	800x400	-	BXL pack 1	3 605217 889270
788926	640x440	580 g/m ²	-	-	-	600x400	-	BXL pack 1	3 605217 889263
NEW 788452	440x290	580 g/m ²	-	-	-	400x250	-	BXL pack 1	3 605217 884527
788925	340x340	580 g/m ²	-	-	-	300x300	-	BXL pack 1	3 605217 889256
786639	1012x662	580 g/m ²	942x592	-	-	-	-	BXL pack 1	3 605217 866394
621104	885x485	580 g/m ²	872x472	-	-	-	-	BXL pack 1	3 605216 211041
621103	755x555	580 g/m ²	672x472	-	-	-	-	BXL pack 1	3 605216 211034
779537	712x482	580 g/m ²	-	637x412	-	-	-	BXL pack 1	3 605217 795373
786754	605x405	580 g/m ²	-	551x351	-	-	-	BXL pack 1	3 605217 867544
779531	521x422	580 g/m ²	-	436x336	-	-	-	BXL pack 1	3 605217 795311
784801	581 ø	580 g/m ²	-	-	511 ø	-	-	BXL pack 1	3 605217 848017
779525	455 ø	580 g/m ²	-	-	412 ø	-	-	BXL pack 1	3 605217 795250
NEW 787058	355 ø	580 g/m ²	-	-	295 ø	-	-	BXL pack 1	3 605217 870582

complementos complements

CUBIERTAS ISOTÉRMICAS PARA PISCINAS DE COMPOSITE COMPOSITE POOL ISOTHERMIC COVERS BÂCHES ÉTÉ POUR PISCINES COMPOSITE COPERTURE ISOTHERMICHE PER PISCINE COMPOSITE



EAN 13

NEW CVKPCOR60	554x252	400 µ	-	-	600x300	BXL pack 1	8 412081 273709
CVKPCO80	758x338	400 µ	-	804x386	-	BXL pack 1	8 412081 270661
CVKPCO66	618x338	400 µ	-	664x386	-	BXL pack 1	8 412081 270654
CVKPCO52	478x338	400 µ	-	524x386	-	BXL pack 1	8 412081 270647
CVKPCO41	Ø 366	400 µ	Ø 410	-	-	BXL pack 1	8 412081 270630

CUBIERTAS DE INVIERNO PARA PISCINAS DE COMPOSITE COMPOSITE POOL WINTER COVERS BÂCHES HIVER POUR PISCINES COMPOSITE COPERTURE INVERNALE PER PISCINE COMPOSITE



EAN 13

NEW CIKPCOR60	624x322	580 g/m ²	-	-	600x300	BXL pack 1	8 412081 273723
CIKPCO80	828x408	580 g/m ²	-	804x386	-	BXL pack 1	8 412081 270708
CIKPCO66	688x408	580 g/m ²	-	664x386	-	BXL pack 1	8 412081 270692
CIKPCO52	548x408	580 g/m ²	-	524x386	-	BXL pack 1	8 412081 270685
CIKPCO41	Ø 480	580 g/m ²	Ø 410	-	-	BXL pack 1	8 412081 270678

CUBIERTAS ISOTÉRMICAS PARA PISCINAS ENTERRADAS IN-GROUND POOLS ISOTHERMIC COVERS
BÂCHES ÉTÉ POUR PISCINES ENTÉRRÉE COPERTURE ISOTHERMICHE PER PISCINE INTERRATA



EAN 13

CVPE800	795x395	300 µ	-	800x400	-	BXL pack 1	 8 4 1 2 0 8 1 2 7 3 9 0 7
CVPE700	695x315	300 µ	-	700x320	-	BXL pack 1	 8 4 1 2 0 8 1 2 7 3 9 1 4
CVPE600	595x315	300 µ	-	600x320	-	BXL pack 1	 8 4 1 2 0 8 1 2 7 3 9 2 1
CVPE500	495x295	300 µ	-	500x300	-	BXL pack 1	 8 4 1 2 0 8 1 2 7 3 9 3 8
CVPE420	Ø 415	300 µ	Ø 420	-	-	BXL pack 1	 8 4 1 2 0 8 1 2 7 3 9 4 5
CVPE350	Ø 345	300 µ	Ø 350	-	-	BXL pack 1	 8 4 1 2 0 8 1 2 7 3 9 5 2
CPERT105	995x495	180 µ	-	-	1000x500	BXL pack 1	 8 4 1 2 0 8 1 2 6 8 3 5 4
CPERT95	895x495	180 µ	-	-	900x500	BXL pack 1	 8 4 1 2 0 8 1 2 6 8 3 4 7
CPERT84	795x395	180 µ	-	-	800x400	BXL pack 1	 8 4 1 2 0 8 1 2 6 8 3 3 0
CPERT63	595x295	180 µ	-	-	600x300	BXL pack 1	 8 4 1 2 0 8 1 2 6 8 3 2 3
CPERT53	495x295	180 µ	-	-	500x300	BXL pack 1	 8 4 1 2 0 8 1 2 6 8 3 1 6

CUBIERTAS ISOTÉRMICAS ISOTHERMIC COVERS COUVERTURES ISOTHERMES COPERTURE ISOTHERMICHE

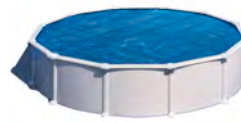

Material: Polietileno
Material: Polyethylene
Matériel: Polyéthylène
Materiale: Polietilene



EAN 13

CPROV1020	995x545	180 μ	-	1000x550	-	-	-	PBH pack 1	8 412081 220536
CPROV915	910x460	180 μ	-	915x470	-	-	-	PBH pack 1	8 412081 980324
CPROV810	805x460	180 μ	-	810x470	-	-	-	PBH pack 1	8 412081 205984
CPROV730	725x370	180 μ	-	730x375	-	-	-	PBH pack 1	8 412081 980331
CPROV610	605x370	180 μ	-	610x375	-	-	-	PBH pack 1	8 412081 205991
CPROV510	485x335	180 μ	-	500x350	-	-	-	PBH pack 1	8 412081 268811
CPROV505	495x295	180 μ	-	500x300	-	-	-	PBH pack 1	8 412081 221823
CPROV700	672x445	180 μ	-	-	710x475	-	-	PBH pack 1	8 412081 205830
CPROV600	620x370	180 μ	-	-	640x390	-	-	PBH pack 1	8 412081 205847
CPROV500	472x305	180 μ	-	-	500x340	-	-	PBH pack 1	8 412081 205854
CPR650	640 ø	180 μ	-	-	-	ø 640	-	PBH pack 1	8 412081 950303
CPR550	545 ø	180 μ	-	-	-	ø 550	-	PBH pack 1	8 412081 940601
CV450	455 ø	180 μ	ø 550	-	-	ø 460	ø 450/460	PBH pack 1	8 412081 202525
CPR400	395 ø	180 μ	-	-	-	-	ø 400	PBH pack 1	8 412081 940625
CV350	345 ø	180 μ	ø 450	-	-	ø 350	ø 350	PBH pack 1	8 412081 202532
CV300	295 ø	180 μ	ø 350	-	-	ø 300	ø 300	PBH pack 1	8 412081 202549
CV250	245 ø	180 μ	ø 300	-	-	ø 240	-	PBH pack 1	8 412081 208565
773326	730x370	267 μ	-	735x375	-	-	-	PBH pack 1	3 605217 733269
773324	610x370	267 μ	-	615x375	-	-	-	PBH pack 1	3 605217 733245
773322	500x300	267 μ	-	505x305	-	-	-	PBH pack 1	3 605217 733221
773320	Ø 550	267 μ	Ø 555	-	-	Ø 550	-	PBH pack 1	3 605217 733207
772999	Ø 460	267 μ	Ø 465	-	-	Ø 460	-	PBH pack 1	3 605217 729996
772997	Ø 360	267 μ	Ø 365	-	-	Ø 360	-	PBH pack 1	3 605217 729972













CUBIERTAS DE INVIERNO WINTER COVERS COUVERTURES POUR L'HIVER COPERTURA INVERNALE



Material: Polietileno
Material: Polyethylene
Matériel: Polyéthylène
Materiale: Polietilene



EAN 13

CIPROV1001	1115x660	120 g/m ²	-	-	1000x550	-	-	-	CBX pack 3	
CIPROV911	1030x560	120 g/m ²	-	-	915x470	-	-	-	CBX pack 3	
CIPROV821	930x560	120 g/m ²	-	-	800x470	710x475	-	-	CBX pack 3	
CIPROV731	820x460	120 g/m ²	-	-	730x375	640x390	-	-	CBX pack 3	
CIPROV611	680x460	120 g/m ²	-	-	610x375	500x340	-	-	CBX pack 3	
CIPROV501	610x410	120 g/m ²	-	-	500x300	-	-	-	CBX pack 3	
CIPR651	730 ø	120 g/m ²	-	-	-	-	ø 640	-	CBX pack 3	
CIPR551	640 ø	120 g/m ²	-	-	-	-	ø 550	-	CBX pack 5	
CIPR451	540 ø	120 g/m ²	-	ø 550	-	-	ø 460	ø 450 ø 460	CBX pack 5	
CIPR401	480 ø	120 g/m ²	ø 440	ø 450	-	-	-	ø 400	CBX pack 5	
CIPR351	440 ø	120 g/m ²	ø 360	ø 350 ø 360	-	-	ø 350	ø 350	CBX pack 5	
CIPR301	380 ø	120 g/m ²	-	-	-	-	ø 300	-	CBX pack 5	
CIPR241	330 ø	120 g/m ²	-	-	-	-	ø 240	-	CBX pack 5	

MANTAS PROTECTORAS BOTTOM PROTECTIVE BLANKET POUR LE SOL DES PISCINES COUVERTURES DE PROTECTION DU FOND TAPPETO DI PROTEZIONE



Material: Poliéster
Material: Polyester
Matériel: Polyester
Materiale: Poliestere

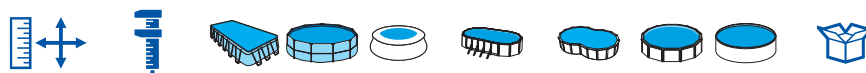

EAN 13

MPROV1100	1100x600	110 g/m ²	-	-	-	1000x550	-	-	-	PBH pack 1	8 4 1 2 0 8 1 2 1 4 5 2 8
MPROV915	950x500	110 g/m ²	-	-	-	915x470	-	-	-	PBH pack 1	8 4 1 2 0 8 1 9 8 0 2 5 6
MPROV810	825x500	110 g/m ²	780x400	-	780x400	810x470	710x475	-	-	PBH pack 1	8 4 1 2 0 8 1 2 0 6 0 0 4
MPROV730	750x400	110 g/m ²	660x280	-	660x280	730x375	640x390	-	-	PBH pack 1	8 4 1 2 0 8 1 9 8 0 2 6 3
MPROV610	625x400	110 g/m ²	530x280	-	530x280	610x375	500x340	-	-	PBH pack 1	8 4 1 2 0 8 1 2 0 6 0 1 1
MPROV500	525x325	110 g/m ²	-	-	-	500x300	-	-	-	PBH pack 1	8 4 1 2 0 8 1 2 3 1 0 7 5
MPR650	650x650	110 g/m ²	-	-	-	-	-	ø 640	-	PBH pack 1	8 4 1 2 0 8 1 9 6 0 1 1 1
MPR550	550x550	110 g/m ²	-	-	ø 550	-	-	ø 550	-	PBH pack 1	8 4 1 2 0 8 1 9 6 0 1 2 8
MPR450	550x500	110 g/m ²	-	ø 440	ø 450	-	-	ø 460 ø 450	ø 460	PBH pack 1	8 4 1 2 0 8 1 9 6 0 1 3 5
MPR400	400x400	110 g/m ²	-	ø 360	-	-	-	ø 350 ø 400	ø 400	PBH pack 1	8 4 1 2 0 8 1 9 6 0 1 4 2
MPR350	500x500	110 g/m ²	-	-	ø 350	-	-	ø 350 ø 300	ø 350	PBH pack 1	8 4 1 2 0 8 1 9 6 0 1 5 9
MPR250	250x250	110 g/m ²	-	-	ø 240	-	-	ø 240	-	PBH pack 1	8 4 1 2 0 8 1 2 0 8 5 7 2

ENROLLADORES DE CUBIERTAS TELESCOPIC COVER ROLLERS
ENROULEURS DE BÂCHES AVVOGLITORE PER PISCINE

REF. 90171

BXL PACK 1



Enrollador piscinas enterradas

Enrollador de cubierta para piscinas enterradas. Ofrece un desarrollo máximo de 5,50m. Ideal para piscinas redondas, cuadradas u ovaladas. Contiene tubos redondos en aluminio anodizado, un volante ergonómico con empuñadura giratoria así como un kit para atar la cubierta.

Enrouleur pour piscines enterrées

Enrouleur de bâche pour piscines enterrées. Il offre un développement maximum de 5,50m. Il convient aux piscines rondes, carrées ou ovales. Il est équipé de tubes ronds en aluminium anodisés, d'un volant ergonomique avec poignée tournante et d'un kit d'attache pour bâche. Cet enrouleur est livré en un seul colis, packaging couleur.

Cover roller for inground pools

Winder cover for in ground pools. Unfolds to a maximum length of 5.50 m. Suitable for round, square or oval swimming pools. Includes round anodised aluminium tubes, an ergonomic hand wheel with revolving handle as well as a kit to attach it to the cover.

Avvolgitore per piscine interrate

Avvolgitore "grandi ruote" per piscine interrate. Si srotola fino a un massimo di 5.50m. Adatto per le piscine tonde, quadrate e ovali. Contiene un tubo in alluminio anodizzato, una ghiera ergonomica con una impugnatura rotatoria e un kit per fissare la copertura. Consegnato in un unico imballo.



REF. 621535

BXL PACK 1



Enrollador piscinas elevadas Luxe

Enrollador para piscina en superficie de longitud entre 2,44 y 6,32 m. Giro sobre el eje para descubrir la superficie de nado. Travesaño de resina. Sistema de enganche compatible con todas las lonas de verano. Tubos telescópicos de aluminio 3 tubos de 76 mm y 2 tubos de 80 mm. Cintas de enganche.

Enrouleur pour piscines hors-sol Luxe

Enrouleur pour piscine hors sol d'une largeur de 2,44 à 6,32 m. Pivote sur un axe pour libérer la surface de nage. Piètement en résine. Système d'accroche compatible avec toutes les bâches été. Tubes télescopiques en aluminium : 3 tubes de 76 mm et 2 tubes de 80 mm. Sangles d'accrochage.

Luxe cover roller for above-ground pools

Roller for pool surface between 2.44 and 6.32 m long. It turns on its axis to reveal the swimming surface. Resin cross member. Hook system compatible with all the summer canvases. Telescopic aluminium tubes: 3 x 76 mm tubes and 2 x 80 mm tubes. Webbing loop.

Avvolgitore per piscine fuori terra Luxe

Avvolgitore per piscine fuori terra di lunghezza compresa tra 2,44 e 6,32 m. Ruotare sull'asse per scoprire la superficie di balneazione. Traversa in resina. Sistema di aggancio compatibile con tutti i tessuti estivi. Tubi telescopici in alluminio 3 tubi da 76 mm e 2 tubi da 80 mm. Cinghie di aggancio.

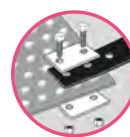

complementos complements



REF. 40135

CBX PACK 2



Enrollador piscinas elevadas

El Enrollador ofrece un desarrollo máximo de 6,5m. Se ata fácilmente a las "playas" de la piscina con 2 placas atornilladas. El uso del enrollador permite una mejor conservación de la cubierta. Incluido: Conectores para piscinas tubulares.

Cover roller for above-ground pools

The Winder unfolds to a maximum length of 6.5 m. It can be easily attached to the "edge" finishing pieces of the pool using 2 bolted plates. The use of the winder enables a better conservation of the cover. Included: Connectors for tubular pools.

Enrouleur pour piscines hors-sol

Enrouleur offrant un développement maximum de 6,5m. Il se fixe facilement sur les 2 "margelles" de la piscine grâce à ses 2 plaques vissées. L'utilisation de l'enrouleur permet de conserver la bâche dans de bonnes conditions. Inclus: Connecteurs pour piscines tubulaires.

Avvolgitore per piscine fuori terra

Avvolgitore che si srotola fino a un massimo di 6.5 m. Si fissa facilmente alla "bordo" della piscina con 2 placche con viti. L'utilizzo dell'avvolgitore permette una migliore conservazione della copertura.



POOL HOUSE

REF. PH54

CBX PACK 1

5,00 x 4,33 x 2,50 m



TOLDO PISCINA

Dimensiones: 5,00 x 4,33 x 2,50 m
Material: Poliéster
Paneles laterales de PVC transparente
3 puertas con cierre de cremallera

POOL HOUSE

Assembled size: 5,00 x 4,33 x 2,50 m
Material: Polyester. Transparent PVC side walls. 3 doors with zipper close. Adaptable to 4m pools.

AUVENT DE PROTECTION

Dimensions : 5,00 x 4,33 x 2,50 m
Matériau : Polyester
Parois latérales en PVC transparent
3 portes avec fermeture éclair

GAZEBO DI PROTEZIONE

Dimensioni: 5,00 x 4,33 x 2,50 m
Materiale: Poliestere
Pannelli laterali in PVC trasparente
3 porte con chiusura a zip

LINERS PARA PISCINA DE MADERA WOODEN POOL LINERS
FONDS POUR PISCINES BOIS LINERS PER PISCINE IN LEGNO



Liner azul (AZ)
 Blue liner (AZ)
 Liner bleu (AZ)
 Liner blu (AZ)



Liner beige (BE)
 Beige liner (BE)
 Liner beige (BE)
 Liner beige (BE)



Sistema colgante
 Hanging system
 Systeme d'accroche
 Con barra di agganciamento



EAN 13

783885	AZ	Ø 511	124cm	75/100	3 605217 838858
786214	BE				3 605217 862143
778689	AZ	Ø 412	119cm	50/100	3 605217 786890
786213	BE				3 605217 862136
786329	AZ	Ø 295	119cm	50/100	3 605217 863294
786337	AZ	942x592	146cm	75/100	3 605217 863379
786219	BE				3 605217 862198
786336	AZ	872x472	146cm	75/100	3 605217 863362
786218	BE				3 605217 862181
786334	AZ	672x472	146cm	75/100	3 605217 863348
786217	BE				3 605217 862174
783809	AZ	637x412	133cm	75/100	3 605217 838094
786216	BE				3 605217 862167
778768	AZ	551x351	119cm	60/100	3 605217 787682
786215	BE				3 605217 862150
778767	AZ	436x336	119cm	60/100	3 605217 787675
785943	AZ	800x400	146cm	75/100	3 605217 859433
785939	AZ	600x400	133cm	75/100	3 605217 859396
785945	AZ	400x250	119cm	75/100	3 605217 859457
788044	AZ	300x300	119cm	60/100	3 605217 880444

LINERS LINERS FONDS LINERS



Liner azul (AZ)
Blue liner (AZ)
Liner bleu (AZ)
Liner blu (AZ)

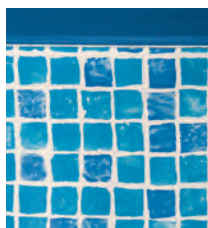

Liner gresite (GR)
Ceramics liner (GR)
Liner carrelage (GR)
Liner mosaicato (GR)



Sistema colgante (SC)
Hanging system (SC)
Systeme d'accroche (SC)
Con barra di agganciamento (SC)

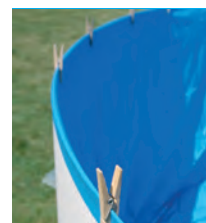

Sistema overlap (OV)
Overlap system (OV)
Systeme à recouvrement (OV)
Sistema overlap (OV)



EAN 13

FPR557	GR	SC	Ø 550	132cm	50/100	8 412081 258249
FPR558	AZ				40/100	8 412081 214504
FPR551			120cm	40/100	8 412081 950648	
770398	GR	OV	Ø 460	120cm	75/100	3 605217 703989
FPR457		SC		132cm	50/100	8 412081 258256
FPR458	AZ		40/100	8 412081 224121		
FPR451			120cm	40/100	8 412081 980485	
FSP450	AZ	OV	Ø 450	90cm	20/100	8 412081 990217
FSP400			Ø 400	90cm	20/100	8 412081 990224
FPR357	GR	SC	Ø 350	132cm	50/100	8 412081 258263
FPR358	AZ	SC		132cm	40/100	8 412081 233918
FPR352				120cm	40/100	8 412081 200576
FPR354				90cm	30/100	8 412081 201177
FSP350				OV	90cm	20/100
FPR301	AZ	SC	Ø 300	120cm	40/100	8 412081 216027
FSP300		OV		90cm	20/100	8 412081 203249
FWPR30				65cm	20/100	8 412081 201191
FPR241		SC	Ø 240	120cm	40/100	8 412081 203010



EAN 13

FPROV1028	AZ	SC	1000x550	132cm	40/100	 8 4 1 2 0 8 1 2 2 4 1 6 9
FPROV917	GR	SC	915x470	132cm	50/100	 8 4 1 2 0 8 1 2 5 8 1 9 5
FPROV918	AZ	SC		132cm	40/100	 8 4 1 2 0 8 1 2 1 4 5 1 1
FPROV915				120cm	40/100	 8 4 1 2 0 8 1 9 8 0 2 7 0
FPROV827	GR	SC		800x470	132cm	50/100
FPROV818	AZ	SC	132cm		40/100	 8 4 1 2 0 8 1 2 2 4 0 9 1
FPROV810			120cm		40/100	 8 4 1 2 0 8 1 2 0 6 0 5 9
FPROV737	GR	SC	730x375		132cm	50/100
FPROV738	AZ	SC		132cm	40/100	 8 4 1 2 0 8 1 2 2 4 1 0 7
FPROV730				120cm	40/100	 8 4 1 2 0 8 1 9 8 0 2 8 7
770399	AZ	OV	730x370	120cm	75/100	 3 6 0 5 2 1 7 7 0 3 9 9 6
FPROV617	GR	SC	610x375	132cm	50/100	 8 4 1 2 0 8 1 2 5 8 2 2 5
FPROV618	AZ	SC		132cm	40/100	 8 4 1 2 0 8 1 2 2 4 1 1 4
FPROV610				120cm	40/100	 8 4 1 2 0 8 1 2 0 6 0 6 6
773486	AZ	OV	610x370	120cm	75/100	 3 6 0 5 2 1 7 7 3 4 8 6 0
FPROV5171	GR	SC	500x350	132cm	50/100	 8 4 1 2 0 8 1 2 6 8 7 6 7
FPROV5071	AZ			120cm	40/100	 8 4 1 2 0 8 1 2 6 8 7 5 0
FPROV517	GR	SC	500x300	132cm	50/100	 8 4 1 2 0 8 1 2 5 8 2 3 2
FPROV500	AZ			120cm	40/100	 8 4 1 2 0 8 1 2 2 1 8 7 8



EAN 13

FPROV707	AZ	SC	700x450	120cm	40/100	 8 4 1 2 0 8 1 2 0 4 3 3 8
FPROV627	AZ	SC	625x375	120cm	40/100	 8 4 1 2 0 8 1 2 0 4 3 4 5
FPROV507	AZ	SC	500x310	120cm	40/100	 8 4 1 2 0 8 1 2 0 4 3 5 2

PROTECTORES PROTECTORS PROTECTEURS PROTEZIONE

Delta MS®

REF. 772060

BXL PACK 1

20 x 1,5m

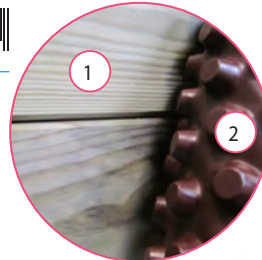

PROTECTOR DE PARED

Rollo de protección y de drenaje alveolar de PEAD (polietileno de alta densidad) para piscina de madera
1- Pared de piscina de madera
2- Rollo de protección y de drenaje alveolar de PEAD

WALL PROTECTOR

Protection and alveolar draining roll of HDPE (High Density Polyethylene) for wooden pool
1- Wood frame
2- Roll of alveolar protection an drainage of HDPE

ROULEAU DE PROTECTION

Pour piscine bois
Rouleau de protection et de drainage alvéolaire en PEHD (polyéthylène haute densité).
1 - Ossature bois
2 - Nappe à excroissances type Delta MS®

PROTEZIONE PER PARETE

Rotolo di protezione del drenaggio alveolare di HDPE (polietilene ad alta densità) per piscina in legno
1- Struttura in legno
2- Rotolo di protezione del drenaggio alveolare di HDPE

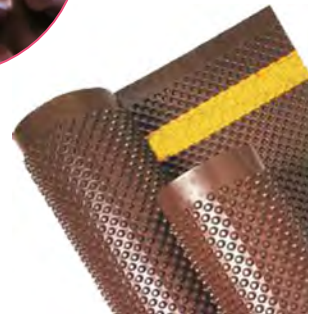

FLOOR PROTECTOR

REF. MPF819

PB PACK 7

81x81cmx4,5mm



PROTECTOR DE SUELO DE PISCINA

Material duradero (Etilvinilacetato (EVA))
Ofrece una protección adicional para el fondo de la piscina
Contiene 9 piezas de 81x81cm = 5,90m²

POOL FLOOR PROTECTOR

Durable material (Ethylene-vinyl acetate (EVA))
Provides added protection for pool floors
Package contains 9 pieces of 81x81cm = 5,90m²

PROTECTEUR DE SOL DE PISCINE

Matériau durable (Éthylène-acétate de vinyle (EVA))
Fournit une protection supplémentaire pour les sols de piscines
L'emballage contient 9 pièces 81x81cm = 5,90m²

PROTEZIONE PER IL FONDO DELLA PISCINA

In materiale resistente (Etilene vinil acetato (EVA))
Evita che il fondo della piscina si danneggi
Il package include 9 pezzi, 81x81cm = 5,90m²

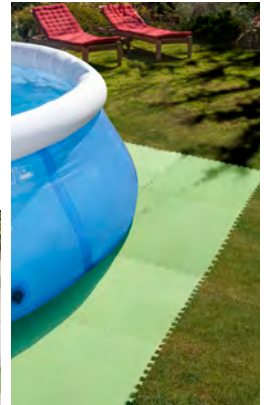

FLOOR PROTECTOR

REF. MPF509GR

PB PACK 8

50x50cmx4,5mm



PROTECTOR DE SUELO DE PISCINA

Material duradero (Etilvinilacetato (EVA))
Ofrece una protección adicional para el fondo de la piscina
Contiene 9 piezas de 50x50cm = 2,25m²

POOL FLOOR PROTECTOR

Durable material (Ethylene-vinyl acetate (EVA))
Provides added protection for pool floors
Package contains 9 pieces of 50x50cm = 2,25m²

PROTECTEUR DE SOL DE PISCINE

Matériau durable (Éthylène-acétate de vinyle (EVA))
Fournit une protection supplémentaire pour les sols de piscines
L'emballage contient 9 pièces 50x50cm = 2,25m²

PROTEZIONE PER IL FONDO DELLA PISCINA

In materiale resistente (Etilene vinil acetato (EVA))
Evita che il fondo della piscina si danneggi
Il package include 9 pezzi, 50x50cm = 2,25m²

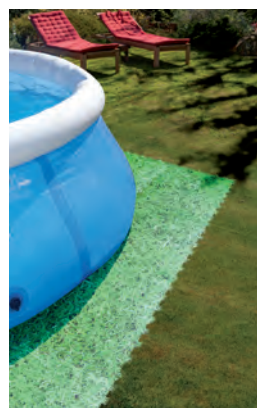
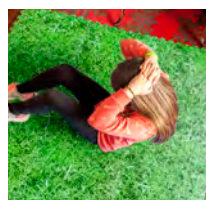

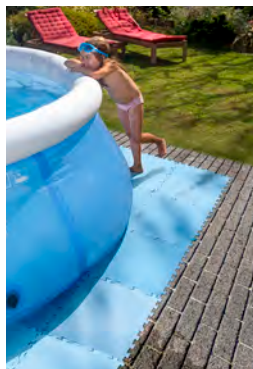

FLOOR PROTECTOR

REF. MPF509

PB PACK 14

50x50cmx4,5mm

8 412081 252001



PROTECTOR DE SUELO DE PISCINA

Material duradero (Etilvinilacetato (EVA)) Ofrece una protección adicional para el fondo de la piscina
Contiene 9 piezas de 50x50cm = 2,25m²

PROTECTEUR DE SOL DE PISCINE

Matériau durable (Éthylène-acétate de vinyle (EVA)) Fournit une protection supplémentaire pour les sols de piscines. L'emballage contient 9 pièces 50x50cm

POOL FLOOR PROTECTOR

Durable material (Ethylene-vinyl acetate (EVA)) Provides added protection for pool floors. Package contains 9 pieces of 50x50 = 2,25m²

PROTEZIONE PER IL FONDO DELLA PISCINA

In materiale resistente (Etilene vinil acetato (EVA)) Evita che il fondo della piscina si danneggi. Il package include 9 pezzi, 50x50cm



BOX MPF509

REF. MPF509BOX60

PB PACK 60

50x50cmx4,5mm

8 412081 258980



BOX PROTECTOR DE SUELO DE PISCINA

Material duradero (Etilvinilacetato (EVA)) El box contiene 60 unidades

BOX PROTECTEUR DE SOL DE PISCINE

Matériau durable (Éthylène-acétate de vinyle (EVA)). L'box contient 60 unités

BOX POOL FLOOR PROTECTOR

Durable material (Ethylene-vinyl acetate (EVA)). Box contains 60 units

BOX PROTEZIONE PER IL FONDO DELLA PISCINA

In materiale resistente (Etilene vinil acetato (EVA)). Il box include 60 unità

REPARADORES DE LINER LINER REPAIR RÉPARATION LINER RIPARAZIONE LINER



REF. 40080

BL PACK 24 DIS 8 427370 400803



Kit reparación liner
Liner repair kit
Kit réparation liner
Kit riparazione liner



REF. V12

BL PACK 50 8 412081 870236



Kit reparador de PVC
PVC repair kit
Kit réparation PVC
Kit per riparazioni PVC



REF. AR202

BL PACK 96 8 412081 960203



Film reparador de PVC
PVC repair film
Film réparation PVC
Pellicola per riparare i liner

ESCALERAS PARA PISCINA ENTERRADA INGROUND POOL LADDERS
ÉCHELLES POUR PISCINES ENTERRÉES SCALETTA PER PISCINA INTERRATA



REF. EIE30

BXL PACK 1



Escalera acero inoxidable AISI3014 para piscina enterrada
3 peldaños dobles

AISI3014 Stainless steel inground pool ladder
3 double steps

Échelle acier inoxydable AISI3014 pour piscine enterrée
3 marches double

Scaletta Inox AISI3014 per piscina interrata
3 gradini doppi



Ref. EPE30

BXL PACK 1



Escalera sintética para piscinas enterradas
4 peldaños

Easy access synthetic ladder for in ground pools
4 steps

Échelle synthétique d'entrée facile pour piscine enterrée
4 marches

Scaletta sintetica per piscina interrata
4 gradini



STANDARD

REF. 40272

BXL PACK 1



Escalera STANDARD para piscina enterrada de 4 peldaños Inox.

Stainless steel STANDARD inground pool ladder - 4 steps.

Échelle modèle STANDARD acier inoxydable pour piscine enterrée - 4 marches

Scaletta STANDARD per piscina interrata da 4 gradini - Inox



STANDARD

REF. 40110

BXL PACK 1



Escalera STANDARD para piscina enterrada de 3 peldaños Inox.

Stainless steel STANDARD inground pool ladder - 3 steps.

Échelle modèle STANDARD acier inoxydable pour piscine enterrée - 3 marches

Scaletta STANDARD per piscina interrata da 3 gradini - Inox

WALL

REF. 40274

BXL PACK 1



Escalera MURO para piscina enterrada de 4 peldaños – Inox

Échelle MURALE acier inoxydable pour piscine enterrée - 4 marches

Stainless steel inground pool WALL ladder - 4 steps

Scaletta MURO per piscina interrata da 4 gradini – Inox



WALL

REF. 40273

BXL PACK 1



Escalera MURO para piscina enterrada de 3 peldaños – Inox

Échelle MURALE acier inoxydable pour piscine enterrée - 3 marches

Stainless steel inground pool WALL ladder - 3 steps

Scaletta MURO per piscina interrata da 3 gradini – Inox

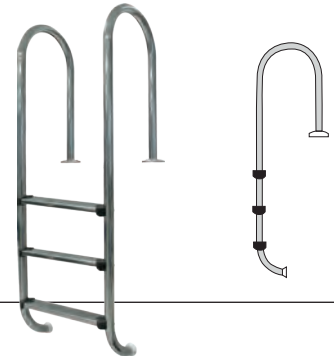

ESCALERA PARA PISCINA DE MADERA WOODEN POOL LADDER
ÉCHELLE POUR PISCINES BOIS SCALETTA PER PISCINA MADERA

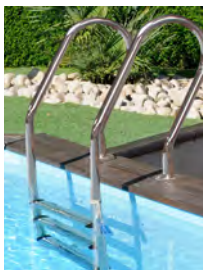

Ref. 126673

CBX PACK 1



Escalera de acero inoxidable 3 peldaños antideslizantes

Échelle acier inoxydable 3 marches anti-dérapantes

Stainless steel ladder 3 non-slip steps

Scaletta Inox per piscina 3 gradini



ESCALERAS PARA PISCINA SOBRE SUELO ABOVE-GROUND POOL LADDERS
ÉCHELLES POUR PISCINES HORS SOL SCALETTA PER PISCINA FUORI TERRA



INOX

REF. AR11680

BXL PACK 1



Escalera de acero inoxidable 142cm
2x4 peldaños + plataforma

Échelle acier inoxydable 142cm
2x4 marches + plateforme

Stainless steel ladder 142cm
2x4 steps + platform

Scala in acciai inossidabile 142cm
2x4 gradini + piattaforma



SAFETY

REF. ES1150

BXL PACK 1



Escalera de seguridad 134cm
2x3 peldaños + plataforma

Échelle sécurité 134cm
2x3 marches + plateforme

Safety ladder 134cm
2x3 steps + platform

Scala di sicurezza 134cm
2x3 gradini + piattaforma



SAFETY

REF. ES1100

BXL PACK 1



Escalera de seguridad 120cm
2x3 peldaños

Échelle sécurité 120cm
2x3 marches

Safety ladder 120cm
2x3 steps

Scala di sicurezza 120cm
2x3 gradini



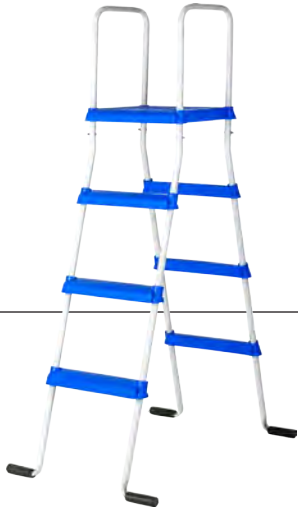

STANDARD

REF. ET1300

BXL PACK 1



Escalera 133cm
2x3 peldaños + plataforma
Échelle 133cm
2x3 marches + plateforme

Stainless 133cm
2x3 steps + platform
Scala 133cm
2x3 gradini + piattaforma



STANDARD

REF. ET1200

BXL PACK 1



Escalera tipo tijera 120cm
2x3 peldaños
Échelle 120cm
2x3 marches

Ladder 120cm
2x3 steps
Scala 120 cm
2x3 gradini



STANDARD

REF. AR109

BXL PACK 1



Escalera tipo tijera 98cm
2x2 peldaños
Échelle 98cm
2x2 marches

Ladder 98cm
2x2 steps
Scala 98cm
2x2 gradini

MONOBLOCS DE FILTRACIÓN FILTRATION KITS ENSEMBLES DE FILTRATION FILTRO MONOBLOCCO

Las impurezas quedan retenidas en el medio filtrante en el interior de la cuba. Son muy compactos, fáciles de instalar, utilizar y no requieren especial atención. Incorporan un prefiltro para retener las partículas excesivamente grandes y evitar dañar la bomba (*). Gracias a su válvula selectora (5/6/7 vías dependiendo del modelo), permiten realizar diferentes funciones: autolimpiado, filtración, vaciado... Los filtros FA6100 / FA6080 / FA6070 / FA6050 / FA6040 / FA6030 están certificados con la norma francesa NF P 90-318 que garantiza que cumplen con las normativas de seguridad establecidas.

Impurities are held by the filter media inside the tank. Sand filters are compact sized, easy to install and use and special care is not required. They include a prefilter to hold the largest particles to prevent pump from any damage (*). Thanks to their multiport valves (5/6 ways depending on the version), different functions can be carried out: self-cleaning, filtration, emptying... Filters FA6100 / FA6080 / FA6070 / FA6050 / FA6040 / FA6030 are certified with the standard French NF P 90-318 ensuring that they comply with the safety regulations set.



REF. FA6100



REF. FA6080



REF. FA6070



REF. FA6050



REF. FA6040



REF. FA6030



W

HP



EAN 13

FA6100	Ø 600 mm	10.000 l/h	485 W	0,66 CV/HP	±130 kg	6	BXL pack 1	
FA6080	Ø 500 mm	8.000 l/h	630 W	0,86 CV/HP	±90 kg	6	BXL pack 1	
FA6070	Ø 430 mm	7.000 l/h	230 W	0,31 CV/HP	±68 kg	6	BXL pack 1	
FA6050	Ø 380 mm	5.000 l/h	180 W	0,24 CV/HP	±46 kg	5	BXL pack 1	
FA6040	Ø 380 mm	4.000 l/h	125 W	0,17 CV/HP	±46 kg	5	BXL pack 1	
FA6030	Ø 300 mm	3.000 l/h	125 W	0,17 CV/HP	±23 kg	5	BXL pack 1	

Les impuretés sont retenues dans le média filtrant à l'intérieur de la cuve. Ces filtres sont très compacts et très faciles à installer et à utiliser, sans grandes exigences. Le filtre est muni d'un pré filtre qui retient les particules excessivement grandes pour éviter d'endommager la pompe (*). Sa vanne multivoie (5/6 voies, suivant le modèle), permet de réaliser diverses fonctions: auto nettoyage, filtrage, vidange... Les filtres FA6100 / FA6080 / FA6070 / FA6050 / FA6040 / FA6030 sont certifiés par la norme française NF P 90-318 garantissant qu'ils respectent les réglementations établies en matière de sécurité.

Le impurità rimangono intrappolate nelle carico filtrante all'interno del cestello. Sono molto compatti, facili da installare e da utilizzare e non richiedono cure particolari. Sono composti da un prefiltro per trattenere le particelle eccessivamente grandi ed evitare il danneggiamento della pompa(*). Grazie alla valvola selettiva della quale sono dotati (5/6/7 uscite a seconda del modello), consentono diverse funzioni: autopulizia, filtrazione, svuotamento... I filtri FA6100 / FA6080 / FA6070 / FA6050 / FA6040 / FA6030 sono certificati dalla normativa francese NF P 90-318 che garantisce la loro conformità alle normative di sicurezza vigenti.



REF. FS500



Con temporizador
With timer
Avec minuteur
Con temporizzatore

REF. FS400T



REF. FS400



REF. FS300



*Sin prefiltro
*Without prefilter
*Sans préfiltre
*Senza prefiltro

REF. FS300NP



*Sin prefiltro
*Without prefilter
*Sans préfiltre
*Senza prefiltro

REF. FS250NP



W

HP



EAN 13

			W	HP				EAN 13
FS500	Ø 500 mm	8.000 l/h	550 W	0,75 CV/HP	±85 kg	5	BXL pack 1	8 4 12081 252339
FS400T	Ø 400 mm	6.000 l/h	230 W	0,34 CV/HP	±40 kg	5	BXL pack 1	8 4 12081 257495
FS400	Ø 400 mm	6.000 l/h	230 W	0,31 CV/HP	±40 kg	5	BXL pack 1	8 4 12081 252322
FS300	Ø 300 mm	4.000 l/h	180 W	0,24 CV/HP	±20 kg	5	BXL pack 1	8 4 12081 252315
FS300NP	Ø 300 mm	4.000 l/h	180 W	0,24 CV/HP	±20 kg	5	BXL pack 1	8 4 12081 257488
FS250NP	Ø 250 mm	4.000 l/h	180 W	0,24 CV/HP	±14 kg	5	BXL pack 1	8 4 12081 264394

complementos complements

BOMBAS PUMPS POMPES POMPE

Gama de bombas autoaspirantes GRE con potencias comprendidas entre 1/3 CV y 2 CV. Se trata de bombas centrifugas de una sola etapa, autocebantes, concebidas para uso con un sistema de filtración de piscina.

Gamme de pompes GRE, avec des puissances comprises entre 1/3 CV et 2 CV. Il s'agit de pompes centrifuges, auto-amorçantes, conçues pour une utilisation avec un système de filtration de piscine.

The self-priming pump range GRE emits power between 1/3 CV and 2 CV. Centrifugal pumps are single stage, self-priming pumps designed for use in a swimming pool filtration systems.

Gamma di pompe autoaspiranti GRE con potenze comprese tra 1/3 CV e 2 CV. Si tratta di pompe centrifughe monostadio, autoadescanti, concepite per l'uso con un sistema di filtrazione per piscina.

PREMIUM

- Ref. PP201 CBX PACK 1
- Ref. PP151 CBX PACK 1
- Ref. PP101 CBX PACK 1



Curvas de rendimiento hidráulico
Hydraulic performance curves
Courbes de performances hydrauliques
Curve delle prestazioni idrauliche

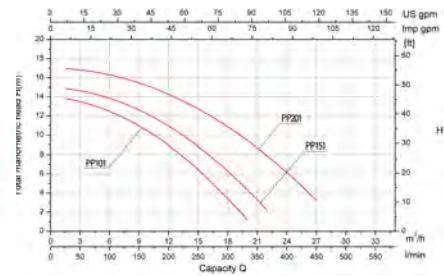

COMFORT

- Ref. PP076 CBX PACK 1
- Ref. PP051 CBX PACK 1
- Ref. PP031 CBX PACK 1



Curvas de rendimiento hidráulico
Hydraulic performance curves
Courbes de performances hydrauliques
Curve delle prestazioni idrauliche

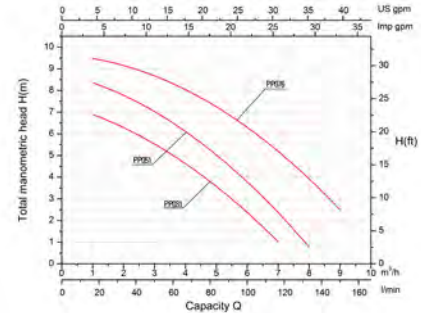

HP

W



EAN 13

Model	HP	W	Flow Rate (l/h)	Capacity (m³)	Ø (mm)	EAN 13
PP201	2 CV/HP	1600 W	27.000 l/h	170m³	Ø 800 mm	8 412081 269535
PP151	1,5 CV/HP	1100 W	22.000 l/h	135m³	Ø 700 mm	8 412081 269542
PP101	1 CV/HP	900 W	20.000 l/h	100m³	Ø 600 mm	8 412081 269559
PP076	3/4 CV/HP	550 W	9.500 l/h	65m³	Ø 500 mm	8 412081 269566
PP051	1/2 CV/HP	450 W	8.500 l/h	50m³	Ø 400 mm	8 412081 269573
PP031	1/3 CV/HP	250 W	7.000 l/h	35m³	Ø 300 mm	8 412081 269580



NEW



FILTRO AQUALOON

REF. FAQ200

BXL PACK 1



FILTRO AQUALOON
Tanque 200 mm. Caudal: 4m³/h.
Filtra cualquier residuo hasta 2 micras.
Conexiones 32 y 38 mm.
Incluye 320g de Aqualoon

AQUALOON FILTER
200 mm tank. Flow rate: 4m³/h.
Filters any residue until 2 micron.
32 and 38 mm connections.
Include 320g aqualoon

MOYEN DE FILTRATION
Cuve 200 mm. Débit 4m³/h.
Filtre n'importe quel résidu jusqu'à 2 microns. Embouts soudés 32 et 38 mm.
Comprend 320g aqualoon

SISTEMA FILTRANTE
Filtro 200 mm. Portata 4m³/h.
Filtra qualsiasi residuo fino a 2 micron
Raccordi 32 e 38 mm.
Include 320g di aqualoon

NEW



AQUALOON

REF. CAQ700

BXL PACK 1



MEDIO FILTRANTE para filtro de cartucho
700gr de AQUALOON = 25kg de ARENA
Filtra cualquier residuo hasta 1 micra
Polietileno. 100% reciclable

FILTER MEDIA cartridge filter
700g packaging equals to 25 Kg sand.
Filters any residue until 1 micron.
polyethylene. 100% Recyclable

MOYEN DE FILTRATION epurateur à cartouche.
700g d'AQUALOON = 25kg de SABLE.
Filtre n'importe quel résidu jusqu'à 1 microns.
Polyéthylène 100% recyclable

SISTEMA FILTRANTE filtri a cartuccia
700gr de AQUALOON = 25kg arena
Filtra qualsiasi residuo fino a 1 micron
Polietilene riciclabile al 100%.

CARGAS FILTRANTES FILTER MEDIA MÉDIAS FILTRANTS CARICO FILTRO



AQUALOON

REF. AQ700

BXL PACK 1



MEDIO FILTRANTE
700gr de AQUALOON = 25kg de ARENA
Filtra cualquier residuo hasta 3 micras
Polietileno 100% reciclable

FILTER MEDIA
700gr AQUALOON = 25kg SAND
Filters any residue up to 3 microns
Polyethylene 100% recyclable

MOYEN DE FILTRATION
700g d'AQUALOON = 25kg de SABLE
Filtre n'importe quel résidu jusqu'à 3 microns
Polyéthylène 100% recyclable

SISTEMA FILTRANTE
700gr de AQUALOON = 25kg de ARENA
Filtra qualsiasi residuo fino a 3 micron
Polietilene riciclabile al 100%.



REF. AR200
PB PACK 1



Arena - Silex 25kg.
Granulometría 0,4-0,8.
Sand - Silex 25 kg.
Grain size 0,4-0,8.
Sable - Silex 25kg.
Granulométrie 0,4-0,8.
Sabbia - Silex 25kg.
Granulometria 0,4-0,8.



REF. VF025
PB PACK 1



Vidrio filtrante saco 25kg
Granulometría 0,5 - 1 mm
Glass filter media 25 kg
Grain size 0,5 - 1 mm
Verre filtrant 25kg
Granulométrie 0,5 - 1 mm
Vetro filtrante 25kg
Granulometria 0,5 - 1 mm

MANGUERAS DE FILTRACIÓN FILTRATION HOSES TUYAUX POUR ÉPURATEURS TUBI DI FILTRAZIONE

Kit mangueras filtración
Kit tuyaux pour épurateurs

Filtration hoses kit
Kit tubi di filtraggio

2 (Ø38mm x 4,5m) + 1 (Ø38mm x 1,5m) + 1 (Ø38mm x 0,68m) + 1 (Ø38mm x 0,58m)
+ 1 (Ø38mm x 0,40m) + 7 abrazaderas / clamps / colliers / fascette

REF. AR2100

BX PACK 1



Manguera seccionable 36,5m
Tuyau sectionnable 36,5m

Sectionable hose 36,5m
Tubo sezionabile 36,5m

Ø38mm

REF. 90160

BX PACK 1



Ø32mm

REF. 90161

BX PACK 1



Manguera para filtro 4m
con 2 terminales
Tuyau pour filtration 4m
avec 2 embouts

Filter hose 4m
with 2 cuffs
Tubo filtrante 4m
con 2 terminali

Ø38mm

REF. 40180

BX pack 1



Ø32mm

REF. 40181

BX pack 1



Manguera de conexión
Tuyau de jonction

Connection hose
Tubo di giunzione

68 cm - Ø38mm

REF. 60222

PB pack 10



58 cm - Ø38mm

REF. 60218

PB pack 10



36 cm - Ø38mm

REF. 60205

PB pack 10

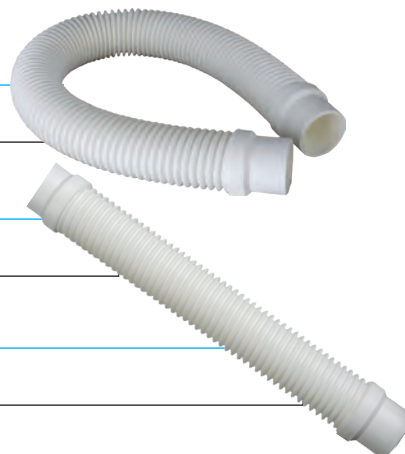

**ADAPTADORES ADAPTERS
ADAPTEURS ADATTATORI**



Adaptador de mangueras Ø32/38mm Ø32/38mm hose bard adaptor
Embout cannelé pour tuyau Ø32/38mm Adattatore per tubo Ø32/38mm

REF. 778196

BX PACK 12



Quitavueltas para manguera Ø38mm Ø38mm hose adaptor with threaded connection
Raccord tournant pour tuyaux Ø38mm Adattatore per tubo Ø38mm

REF. 40091

BX PACK 30



2 conectores Ø38 2 connectors Ø38
+ 4 abrazaderas Ø38 + 4 clamps Ø38
2 manchons pour branchement 2 raccordi Ø38
tuyaux Ø38 + 4 colliers Ø38 + 4 fascette Ø38

REF. AR509

CS pack 10



2 conectores Ø38/32 + 2 connectors Ø38/32
4 abrazaderas Ø38/Ø32 + 4 clamps Ø38/ Ø32
2 manchons pour branchement 2 raccordi Ø38/32 +
tuyaux Ø38/32 + 4 colliers Ø38/Ø32 4 fascette Ø38/Ø32

REF. AR511

CS pack 10

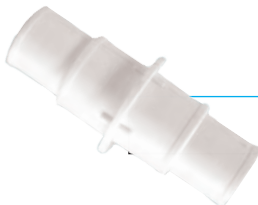

Unión 2 mangueras flotantes 2 vacuum hoses union
Ø38mm y 32mm Ø38mm and 32mm
Liaison pour tuyaux flottants Raccordo per unire 2 tubi
Ø38mm et 32mm Ø32mm – 38mm

REF. 40009

DIS PACK 12



Adaptador de mangueras 38/32mm 38/32mm hose adapter
Adaptateur de tuyaux Ø38/32mm Adattatore per tubo 32/38mm

REF. 40095

BX PACK 20



SKIMMERS PARA PISCINAS DE ACERO STEEL WALL POOLS SKIMMERS SKIMMERS POUR PISCINE PAROI ACIER SKIMMERS PER PISCINA IN ACCIAIO



REF. AR100 BXL PACK 1



Skimmer
+ boquilla de impulsión
Skimmer
+ buse de refoulement

Skimmer
+ return fitting
Skimmer
+ bocchetta



REF. AR100W BXL PACK 1



Skimmer
+ boquilla de impulsión
Skimmer
+ buse de refoulement

Skimmer
+ return fitting
Skimmer
+ bocchetta



REF. AR100G BXL PACK 1



Skimmer
+ boquilla de impulsión
Skimmer
+ buse de refoulement

Skimmer
+ return fitting
Skimmer
+ bocchetta

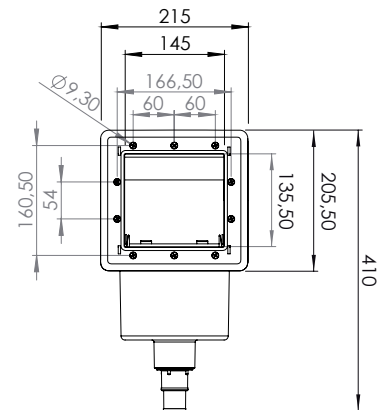

REPUESTOS DE FILTRACIÓN FILTRATION SPARE PARTS ACCESSOIRES POUR FILTRATION RICAMBI PER FILTRAZIONE



REF. AR500
CS PACK 6



Cesto para skimmer
Skimmer Basket
Panier pour skimmer
Cesto prefiltro
Ø ext. 16,2 cm ↑5,5 cm Ø int. 11 cm



REF. AR501
CS PACK 12



Compuerta para skimmer
Weir for skimmer
Volet pour skimmer
Sportellino
12 x 14,5 x 2 cm



REF. AR502
CS PACK 12



Junta doble skimmer
Skimmer layer
Joint pour skimmer
Giunto doppio di stagno
ext. 20,5 x 19,5 x 0,5 cm
int. 14,8 x 13,9 x 0,5 cm



REF. AR521
CS PACK 12



Junta doble skimmer + 2 juntas de
válvula de retorno
Double seal for skimmer + 2 seals for
return valve
Joint double skimmer + 2 joints
pour buse de refoulement
Guarnizione doppia standard Skimmer +
2 guarnizioni per la valvola di ritorno



REF. AR503
CS PACK 6 8 4 1 2 0 8 1 2 0 6 5 0 9

Boquilla de impulsión
Return fitting
Buse de refoulement
Valvola di impulsione completa



REF. AR505
CS PACK 8 8 4 1 2 0 8 1 2 0 8 6 1 9

Tapa para conexión de manguera
limpiafondos
Lid for connecting the vacuum
hose to the skimmer
Couvercle pour relier le tuyau
flottant au skimmer
Adattatore per puliscifondo



REF. AR506
CS PACK 8 8 4 1 2 0 8 1 2 0 8 6 0 2

Manómetro
Pressure gauge
Manomètre
Manometro



REF. AR508
CS PACK 6 8 4 1 2 0 8 1 2 0 8 5 8 9

Zuncho universal
Filter ring
Collier de fixation
Ghiera filtro



REF. AR512
CS PACK 12 8 4 1 2 0 8 1 2 2 1 6 0 1

Válvula apertura/cierre Ø38-Ø32
Open/close valve Ø38-Ø32
Vanne ouverture/fermeture Ø38-Ø32
Valvola di apertura/chisura Ø38-Ø32



REF. 621702
CBX PACK 1 3 6 0 5 2 1 6 2 1 7 0 2 9

Válvula cuarto de vuelta
¼ Turn valve
Vanne ¼ de tour
Valvola ¼ di giro



REF. AR510
CS PACK 24 8 4 1 2 0 8 1 2 1 5 7 8 5

Cintaflón y 4 abrazaderas
Cintaflon and 4 clamps
Teflon et 4 colliers
Nastro Teflon e 4 fascette

complementos complements

REF. 40045

CS PACK 30



10 filtros de skimmer
10 filtres pour skimmer

10 filter savers
10 filtri di skimmer

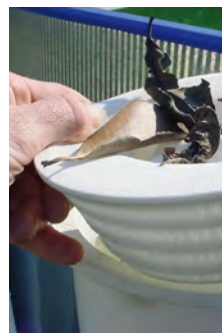

REF. FSK10

DIS pack 12



Filtros de skimmer con velcro
10 unidades
Prefiltres jetables de skimmer
aver velcro. 10 unités.

Pre-filter fabric bag for use in skimmer
using velcro. 10 units.
Filtri di skimmer con velcro
10 unità



REF. 042734

DIS PACK 36



Water Lily

Colocado en la superficie del agua en el interior de la cesta skimmer, absorbe y retiene las materias grasas acumuladas por la circulación del agua.

Water Lily

Posé à la surface de l'eau dans le panier de skimmer, Water Lily absorbe et retient les substances grasses.

Water Lily

Placed in the basket skimmer, absorbs and retains all oily substances brought through by the circulating water.

Water Lily

Posta sulla superficie dell'acqua nel cestello dello skimmer, assorbe e trattiene le sostanze grasse raccolte grazie alla circolazione dell'acqua.



REF. WFL6

DIS pack 12



Espojas absorbentes de grasa
6 unidades

Eponges absorbantes de residus gras
6 unités

Grease absorbing sponge for skimmer
6 units

Sugne che assorbe e trattiene le
sostanze grasse
6 unità



FILTROS DE CARTUCHO CARTRIDGE FILTER EPURATEUR À CARTOUCHE FILTRI A CARTUCCIA

Están especialmente concebidos para piscinas con un volumen de agua medio-inferior. Son muy sencillos de utilizar y su mantenimiento se limita a la limpieza o sustitución del cartucho o filtro de recambio, cuando éste ha quedado obstruido por la excesiva carga de suciedad.

Ils sont spécialement conçus pour les piscines d'un volume d'eau moyen inférieur. Ils sont très faciles à utiliser et l'entretien se limite au nettoyage ou au remplacement de la cartouche ou du filtre, quand il est bouché par un excès de saletés.

Specially designed for medium-low water volume pools. Cartridge filters are very easy to use and their maintenance is limited to the cartridge cleaning or replacement when dirt is blocking it.

Pensati specialmente per piscine con un volume di acqua medio-basso. Sono molto semplici da usare e la manutenzione si limita alla pulizia o sostituzione della cartuccia o della cartuccia di ricambio, quando questa è ostruita da eccessive impurità.



REF. AR125





REF. AR124
REF. AR121E



W



EAN 13

AR125	3.800 l/h	70 W	AR82	BXL pack 1	
AR124	3.800 l/h	70 W	AR82	BXL pack 1	
AR121E	2.000 l/h	72 W	AR86	BXL pack 1	

CARTUCHOS CARTRIDGES CARTOUCHES CARTUCCIA

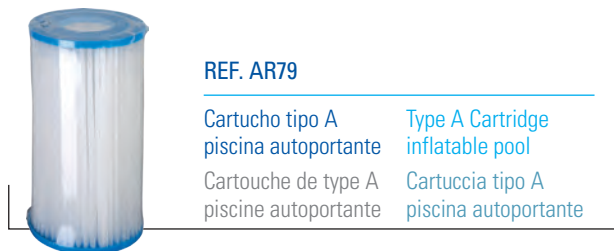

REF. AR79

Cartucho tipo A piscina autoportante
Type A Cartridge inflatable pool
Cartouche de type A piscine autoportante
Cartuccia tipo A piscina autoportante



REF. 90182

Limpiador de cartucho de filtro
Filter cartridge cleaner
Nettoyeur de cartouche de filtre
Pistola per pulire le cartucce







EAN 13



REF. AR86

Cartucho
Cartouche
Cartridge
Cartuccia

AR86	AR121/118	CS pack 12	
AR82	AR125/124/118	CS pack 12	
AR89	AR11806	CS pack 12	
AR79	Type A	PB pack 18	

ELECTRÓLISIS DE SAL SALT CHLORINATOR ELECTROLYSE AU SEL ELETTROLISI SALINA

Los cloradores por electrolisis de sal generan cloro para la desinfección de la piscina a partir de sal. La electrolisis de sal tiene varias ventajas: genera y dosifica automáticamente el cloro en la piscina, evita el almacenamiento y la manipulación de producto químico y es totalmente seguro, ya que sólo utiliza sal común.

Les chlorinateurs par électrolyse au sel génèrent du chlore pour la désinfection de la piscine grâce au sel. L'électrolyse au sel présente plusieurs avantages : Elle génère et dose automatiquement le niveau de chlore dans la piscine, évite le stockage et la manipulation de produits chimiques et est complètement sûre, étant donné qu'elle n'emploie que du sel commun.

Through electrolysis of salt, the chlorinators generate chlorine and salt to disinfect the swimming pool. The electrolysis of salt has various advantages: Generating and automatically dosing the chlorine in the swimming pool, avoids the handling and storage of chemical products and it completely safe, using only sodium chloride.

I clorinatori per elettrolisi salina producono cloro per la disinfezione della piscina partendo dal sale. L'elettrolisi salina ha diversi vantaggi: produce e provvede al dosaggio automatico del cloro nella piscina, evita l'immagazzinamento e l'uso di prodotti chimici ed è del tutto sicura in quanto fa uso del sale comune.

PARA PISCINAS ELEVADAS Y ENTERRADAS FOR ABOVE GROUND AND IN GROUND POOLS POUR PISCINES ENTERRÉES ET HORS SOL PER PISCINE INTERRATE E FUORI TERRA

GRE SALT OPTIMUS

REF. ESP100 BXL PACK 1



Hasta 100m³
Producción de cloro: 19-21 g/h
Jusqu'à 100m³
Production de chlore: 19-21 g/h

Until 100m³
Chlorine production: 19-21 g/h
Fino a 100m³
Produzione di cloro: 19-21 g/h

REF. ESP60 BXL PACK 1



Hasta 60m³
Producción de cloro: 13-15 g/h
Jusqu'à 60m³
Production de chlore: 13-15 g/h

Until 60m³
Chlorine production: 13-15 g/h
Fino a 60m³
Produzione di cloro: 13-15 g/h

REF. ESP30 CBX PACK 1



Hasta 30m³
Producción de cloro: 7,5-8,5 g/h
Jusqu'à 30m³
Production de chlore: 7,5-8,5 g/h

Until 30m³
Chlorine production: 7,5-8,5 g/h
Fino a 30m³
Produzione di cloro: 7,5-8,5 g/h



GRE BALANCE

REF. EESB55 CBX PACK 1



Hasta 55m³
Producción de cloro: 8 g/h
Fácil instalación, sin mantenimiento
Jusqu'à 55m³
Production de chlore: 8g/h
Facile à installer, sans maintenance

Until 55m³
Chlorine production: 8 g/h
Easy installation, maintenance free
Fino a 55m³
Produzione di cloro: 8 g/h
Semplice da installare, non necessita di manutenzione



PARA PISCINAS ENTERRADAS FOR IN GROUND POOLS
POUR PISCINES ENTERRÉES PER PISCINE INTERRATE

Electrolisis de sal para piscinas enterradas
 Generación automática de cloro y dureza del agua. Inversión automática de polaridad.
 Apta para temperatura de agua superior a 15°C y un pH entre 7,0 y 7,2.

Salt chlorinator for in-ground pools Automatic chlorine and water hardening creation. Automatic polarity reversal. Suitable for water temperatures above 15 °C and a pH reading between 7.0 and 7.2.

Chlorinateur pour piscines enterrées Production automatique de chlore et augmentation de la dureté de l'eau. Inversion automatique de la polarité. Adapté à la température de l'eau supérieure à 15 °c et un pH compris entre 7.0 et 7.2.

Clorinatore di piscine interrato Generazione automatica di cloro e durezza dell'acqua. Esclusivamente per piscine interrato. Inversione di polarità automatica. Adatto per acque con temperature superiori a 15°C e pH tra 7,0 e 7,2.

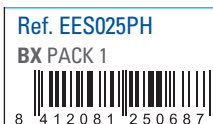
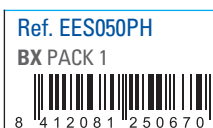

	EES025PH	EES050PH	EES080PH
Hasta Until Jusqu'à Fino a	25 m ³	50 m ³	80 m ³
Tensión de servicio Standard working voltage Tension de service standard Tensione di lavoro	230 V AC, 50 Hz./60 Hz.		
Salida (dc) Output (dc) Sortie (dc) Uscita (c.c.)	3.5 A x 2	6 A x 2	3.5 A x 6
Producción (g/h) Production (g/h) Production (g/h) Produzione (g/h)	6 - 7	10-12	17-21
Capacidad piscina (m ³) Pool volume (m ³) Capacité piscine (m ³) Volume piscine (m ³) Templado: 16-24°C Warm 16-24°C Tempéré: 16-24°C Calore: 16-24°C Cálido: +25°C Hot: +25°C Chaud: +25°C Calore: +25°C	40 25	60 50	100 80
Detector flujo Flow detector Détecteur flux Rilevatore di flusso	Detector gas Gas detector Détecteur gaz Rilevatore di gas		
Rango de salinidad/Temperatura: 3 12 g./l. / +15 - 40°C Salinity / Temperature range: 3 12 g./l. / +15 - 40°C Niveau de salinité / Température : 3 12 g./l. / +15 - 40°C Grado de salinitá / Range di temperatur: 3 12 g./l. / +15 - 40°C			
Electrodos : Titanio con recubrimiento AUTO-LIMPIANTE, calidad ESTANDAR. Duración estimada: 3.000-5.000 horas (dependiendo de la calidad del agua) Electrodes : SELF-CLEANING coated Titanium Estimated lifetime: 3.000-5.000 hours of operation (depending on water quality) Electrodes : Titane avec recouvrement AUTO-NETTOYANTE. Temps de vie PREVU: 3.000-5.000 heures (suivant la qualité de l'eau) Elettrodi : Autopulenti rivestiti in titanio. Tempo di vita 3.000 - 3.500 H (dipende dalla qualità' dell'acqua)			
Control producción Production control Contrôle production Controllo produzione	0 - 100 % (5 niveles de producción) 0 - 100 % (5 production levels) 0 - 100 % (5 niveaux de production) 0 - 100 % (5 livelli di produzione)		
Inversión polaridad Polarity switch Inversion polarité Inversione di polarità	Programmable: 2 ⁽¹⁾ / 3 horas (jumper en plac de control) + modo test Programmable: 2 ⁽¹⁾ / 3 hours (jumper in control board) + test mode Programmable: 2 ⁽¹⁾ / 3 heures (jumper en plaque de contrôle) + mode test Programmabile : 2 ⁽¹⁾ / 3 ore con quadro di controllo e test mode		
Protección nivel de sal Salt level protection Protection niveau de sel Protezione livello sale	Protección automática de producción Automatic protection of output current Protection automatique de production Protezione automatica di corrente in uscita		

⁽¹⁾ Configuración fábrica Factory default Réglages usine Impostazione di fabbrica

SAL ESPECIAL PARA PISCINA POOL SALT SEL SPÉCIAL PISCINE SALE PER PISCINE



REF. 90365

PB PACK 1



Sal compacta
saco 25kg

Sel compacté
sac 25kg

Compact salt
bag 25kg

Sale compatto
25kg

REF. AR2000

BXL PACK 1



Kit Bypass

Contiene: 3 Válvulas apertura/cierre + 2 mangueras Ø38 mm x 1,5 m + 6 piezas de reducción Ø38 - 50 mm para encolar + 4 abrazaderas

Kit Bypass

Comprend: 3 vannes ouverture / fermeture + 2 tuyaux Ø38 cm x 1,5 m + 6 pièces réduction Ø38 - 50 mm à coller + 4 colliers

Bypass kit

Contains: 3 opening/closing valves + 2 hoses Ø38 mm x 1,5 m + 6 reduction parts Ø38 - 50 mm to glue + 4 lamps

Kit Bypass

Contiene: 3 valvole di apertura/chiusura + 2 tubi flessibili Ø38 cm x 1,5 m + 6 pezzi adattatori Ø38 - 50 mm da incollare + 4 fascette

BOMBA DOSIFICADORA Y CONTROLADOR POOL DOSING SYSTEMS CONTRÔLEUR ET DOSEUSE REGOLATORE E DOSATORE

REF. CPH14

BXL PACK 1



El controlador de pH con bomba peristáltica para piscina enterrada automatiza la regulación del pH, lo que permite estabilizar el pH en el valor ideal para su confort y optimizar la eficacia del tratamiento de desinfección.

Le contrôleur de pH avec pompe péristaltique pour piscine enterrée automatise la régulation du pH, ce qui permet de stabiliser le pH sur la valeur idéale pour votre confort et optimiser l'efficacité du traitement de désinfection.

pH-Control dosing system is a peristaltic pump designed to maintain a chosen pH level on inground pools, allowing stabilize the pH in the ideal value for comfort and to optimize the efficiency of the disinfection treatment.

Il regolatore di pH con pompa peristaltica per piscine interrata automatizza la regolazione del pH consentendo di stabilizzarlo su un valore ideale e ottimizzando l'efficacia del trattamento di disinfezione.

REF. BDP4

BXL PACK 1



Bomba dosificadora peristáltica. Caudal variable 4 l/h y 1,5 Bar. Permite dosificar el producto químico de forma fácil y segura.

Pompe doseuse péristaltique. Vitesse variable 4l/h et 1,5 bar. Permet le dosage de produit chimique de façon facile et précise.

Peristaltic dosing pump. Variable flow rate. 4 l/h and 1,5 Bar.

Safe and easy way of dosing of the chemical product UV-C.

Pompa per il dosaggio del prodotto chimico.

Pressione variabile 4 l/h e 1,5 Bar

**SEGURIDAD PISCINA Y ACCESORIO POOL SECURITY AND ACESORY
PROTECTION POUR PISCINE ET ACCESSOIRE PROTEZIONE PER PISCINE E ACCESSORIO**



REF. 779700

CBX PACK 1



3 605217 797001

Barrera de protección para piscinas.

Módulo premontado.
Longitud adaptable.
Adaptable a diferentes formas de piscina.
Módulo de 3,66 m de uso individual.
Altura de la barrera: 1,25 m.
Tejido efecto transparente que permite una visibilidad excelente de la piscina.

Safety fence for swimming pool.

Ready to install.
Adjustable in length to answer all configurations.
3,66m module for individual use.
Fence height : 1,25m.
Transparent net witch allows an excellent visibility of the swimming pool.

Barrière de protection pour piscine.

Module pré-monté.
Adaptable en longueur pour répondre à toutes les configurations.
Module de 3,66m à usage individuel.
Hauteur de la barrière : 1,25m.
Toile effet «transparent» qui permet une excellente visibilité du bassin.

Barriera di protezione per piscine.

Modulo pre installato.
Lunghezza adattabile in base alle forme della piscina. Modulo di 3,66m ad uso individuale. Altezza della barriera:1,25 Tessuto effetto trasparente che permetta una visibilità eccellente della vasca.



REF. 770270

CBX PACK 1



3 605217 702708

Alarma de piscina

Vigilancia máxima.
Detector de inmersión certificado DE CONFORMIDAD con la norma NF P90 307/A1 por el LNE. Sin activación imprevista. Se coloca en modo vigilancia automática 15 minutos después del baño. Información permanente sobre el estado de la vigilancia.

Pool alarm

Maximum surveillance.
Immersion detector with CONFORMITY certificate with the NF P90 307/A1 Standard by LNE. Without unexpected activation. Automatically enters into surveillance mode 15 minutes after the last use of the pool. Permanent information about the surveillance status.



Alarme de piscine

Surveillance maxi.
Décteur d'immersion certifié CONFORME à la norme NF P90 307/A1 par le LNE. Aucun déclenchement intempestif. Remise en surveillance automatique 15 minutes après la baignade. Information permanente sur l'état de surveillance.

Allarme per piscina

Massimo livello di vigilanza.
Rilevatore di immersione certificato IN CONFORMITÀ con la normativa NF P90 307/A1 dell'LNE. Senza attivazione imprevista. Si posiziona in modalità di vigilanza automatica 15 minuti dopo l'utilizzo della piscina. Informazione permanente sullo stato di vigilanza.



ELASTIC SWIMMER

REF. PTR84

CBX PACK 1



8 412081 272573

Nueva manera revolucionaria de mantenerse en forma en la piscina. Posible color personalizado. Diseño especial para piscinas sobre el suelo. También apto para piscinas enterradas.

New revolutionary way to keep fit in the pool. Possible colour customization. Special design for above ground pools. Also suitable for in-ground pools..

Nouvelle manière révolutionnaire de rester en forme dans la piscine. Possibilité de personnaliser la couleur. Design special pour piscines hors sol et enterrées.

Nuovo modo rivoluzionario per mantenersi in forma in piscina. Possibilità di personalizzare il colore. Speciale design per piscine fuori terra. Adatto anche per piscine interrato

ILUMINACIÓN PARA PISCINAS ENTERRADAS IN GROUND POOLS LIGHTING ÉCLAIRAGE POUR PISCINES ENTERRÉES ILLUMINAZIONE PER PISCINE INTERRATE

REF. PLCH144 BL PACK 1



8 412081 250816

Proyector 144 LEDs COLOR (RGB) piscina enterrada de HORMIGÓN.
Projecteur de 144 LEDS de COULEUR pour piscine enterrée BÉTON.

Projector with 144 LEDs, colour RGB for CONCRETE pools.
Faretto Ø 28 x 7, 144 LED MULTICOLOR RGB, per piscine interrate in MURATURA

REF. PLCL144 BL PACK 1



8 412081 250823

Proyector 144 LEDs COLOR (RGB) piscina enterrada de LINER.
Projecteur de 144 LEDS de COULEUR pour piscine enterrée avec LINER.

Projector with 144 LEDs, colour RGB for LINER pools.
Faretto Ø 28 x 7, 144 LED MULTICOLOR RGB, per piscine interrate con LINER.



REF. PLBH144 BL PACK 1



8 412081 250793

Proyector 144 LEDs blanco piscina enterrada de HORMIGÓN.
Projecteur de 144 LEDS BLANCHES pour piscine enterrée BÉTON.

Projector with 144 white LEDs for CONCRETE pools
Faretto Ø 28 x 7, 144 LED color BIANCO, per piscine interrate in MURATURA.

REF. PLBL144 BL PACK 1



8 412081 250809

Proyector 144 LEDs BLANCO piscina enterrada de LINER.
Projecteur de 144 LEDS BLANCHES pour piscine enterrée LINER.

Projector with 144 WHITE LEDs for LINER in-ground pools.
Faretto Ø 28 x 7, 144 LED color BIANCO, per piscine interrate con LINER.



PISCINAS ENTERRADAS Y PISCINAS MADERA IN GROUND AND WODDEN POOLS POUR PISCINES ENTERRÉES ET BOIS PER PISCINE INTERRATE ED IN LEGNO

REF. PLREB BL PACK 1



8 412081 265254

Proyector LED BLANCO para piscina enterrada y de madera
Projecteur LED BLANCHE pour piscine enterrée et bois

WHITE LED projector for in-ground and wodden pools
Faretto LED BIANCO per piscina interrata e in legno

REF. PLREC BL PACK 1



8 412081 265261

Proyector LED COLOR para piscina enterrada y madera.
Con control remoto
Projecteur LED de COULEUR pour piscine enterrée et bois.
Avec télécommande.

COLOR LED projector for in-ground and wooden pools.
With remote control.
Faretto LED MULTICOLOR per piscina interrata e in legno.
Include telecomando.





REF. LLEDP56W

CBX PACK 1



Lámpara LED BLANCA PAR56 de muy fácil instalación 100% fabricada en EU (fábrica propia). Los LED ofrecen una vida útil de 100.000h y un flujo del 70% transcurridas 60.000h. Importantes ahorros en energía respecto a una lámpara halógena: hasta un 92%. 3 años de garantía.

Ampoule LED BLANCHE PAR56 très facile à installer 100% fabriquée dans la CEE (usine propre). Les ampoules offrent une durée de vie de 100 000 h et un flux de 70% après 60.000h. Importantes économies d'énergie par rapport à une ampoule halogène: jusqu'à 92%. 3 ans de garantie.

Easily installed PAR56 WHITE LED lamp 100% manufactured in EU (own production). LEDs has a useful life of 100,000 h and a 70% flow after 60,000 h. Important energy savings regarding a halogen lamp: up to 92%. 3 years guarantee.

Lampada PAR56 LED BIANCA PAR56 di semplicissima installazione, prodotta al 100% in EU (produzione propria). Offre una durata utile di 100.000 ore e un flusso del 70% dopo 60.000 ore. Ciò consente notevoli risparmi di energia rispetto a una lampada alogena: fino al 92% circa. 3 anni di garanzia.



REF. LLEDP56C

CBX PACK 1



Lámpara LED COLOR PAR56 de muy fácil instalación 100% fabricada en EU (fábrica propia). Los LED e ofrecen una vida útil de 100.000h y un flujo del 70% transcurridas 60.000h. Importantes ahorros en energía respecto a una lámpara halógena: hasta un 88%. 12 colores y 8 secuencias. 3 años de garantía.

Ampoule LED COULEUR PAR56 très facile à installer 100% fabriquée dans la CEE (usine propre). Les ampoules offrent une durée de vie de 100 000 h et un flux de 70% après 60 000 h. Importantes économies d'énergie par rapport à une ampoule halogène: jusqu'à 88%. 12 couleurs et 8 séquences. 3 ans de garantie.

Easily installed PAR56 COLOUR LED lamp 100% manufactured in EU (own production). LED has a useful life of 100,000 h and a 70% flow after 60,000 h. Important energy savings regarding a halogen lamp: up to 88% 12 colors and 8 sequences. 3 years guarantee.

Lampada LED COLOR PAR56 di semplicissima installazione, prodotta al 100% in EU (produzione propria). Offre una durata utile di 100.000 ore e un flusso del 70% dopo 60.000 ore. Ciò consente notevoli risparmi di energia rispetto a una lampada alogena: fino al 88% circa. 12 colori e 8 sequenze. 3 anni di garanzia.



REF. 40710

BX PACK 12



Bombilla 300w para proyector.
Ampoule 300w pour projecteur.

300w bulb for underwater light.
Lampada 300w per faro.

ILUMINACIÓN PARA PISCINAS SOBRE SUELO ABOVE GROUND POOLS LIGHTING ÉCLAIRAGE POUR PISCINES HORS SOL ILLUMINAZIONE PER PISCINE FUORI TERRA

Ref. PLPB14

CBX PACK 1



Projector LED BLANCO para conectar a la válvula de retorno. Hasta un 90% de ahorro de energía. Vida útil de 50,000h. 1.600 lumens.

Projecteur LED BLANCHE pour connecter à la buse de refoulement. Jusqu'à 90% d'économie d'énergie. Durée utile de 50,000. 1.600 lumens.

WHITE LED projector to connect to the return valve. Up to 90% energy saving. Useful life of 50,000h. 1.600 lumens.

Proiettore LED BIANCO per connessione alla valvola di ritorno. Fino al 90% di risparmio di energia. Durata utile di 50.000 ore. 1.600 lumens.



REF. LEDRW

CBX PACK 12



Projector LED BLANCO de alto rendimiento para conectar a la válvula de retorno. Adaptable a piscinas elevadas tanto autoportantes como de pared rígida. Caudal mínimo necesario: 3.000 l/h. Funciona sin necesidad de batería.

Projecteur LED BLANCHE à haut rendement pour connecter à la buse de refoulement. Adaptable à des piscines hors-sol, aussi bien autoportantes qu'avec des parois rigides. Débit minimum nécessaire : 3 000 l/h. Fonctionne sans nécessité de batterie.

WHITE LED projector for connecting to the return valve. Adaptable for movable above ground pools with rigid walls. High performance WHITE LEDs. Generates light at no cost, does not need batteries. Minimal flow needed: 3000 l/h

Proiettore LED BIANCO a resa elevata per connessione alla valvola di ritorno. Si adatta a piscine fuori terra, sia autoportanti che a parete rigida. Flusso minimo necessario: 3.000 l/h. Funziona senza batteria.



REF. LEDRC

CBX PACK 12



Projector LED COLOR de alto rendimiento para conectar a la válvula de retorno. Adaptable a piscinas elevadas tanto autoportantes como de pared rígida. Caudal mínimo necesario: 3.000 l/h. Funciona sin necesidad de batería.

Projecteur LED COULEUR à haut rendement pour connecter à la buse de refoulement. Adaptable à des piscines hors-sol, aussi bien autoportantes qu'avec des parois rigides. Débit minimum nécessaire : 3 000 l/h. Fonctionne sans nécessité de batterie.

COLOUR LED projector for connecting to the return valve. Adaptable for movable above ground pools with rigid walls. High performance COLOUR LEDs. Generates light at no cost, does not need batteries. Minimal flow needed: 3000 l/h

Proiettore LED COLOR a resa elevata per connessione alla valvola di ritorno. Si adatta a piscine fuori terra, sia autoportanti che a parete rigida. Flusso minimo necessario: 3.000 l/h. Funziona senza batteria.





x 8



x 8



x 12

REF. BL8812

BXL PACK 1



8 412081 268217

Box de projectores
90173 x 8 unidades
PLED2 x 8 unidades
PLED1C x 12 unidades

Light projector BOX
90173 x 8 units
PLED2 x 8 units
PLED1C x 12 units

Box de projecteurs
90173 x 8 unités
PLED2 x 8 unités
PLED1C x 12 unités

Contenitore con faretto
90173 x 8 unità
PLED2 x 8 unità
PLED1C x 12 unità



REF. PLED1C

BL PACK 12



8 412081 257518

Proyector LED COLOR para piscina elevada de acero. Fácil instalación, se pega a la chapa mediante un imán. Incorpora mando a distancia para fácil manejo. Tecnología Led de bajo consumo.

COLOR LED projector for above ground pools. Stick to the sheet with a magnet and ready to use. Includes remote control for easy operation. Energy-saving LED technology.

Projecteur LED de COULEUR pour piscine hors sol. Ils sont spécialement conseillés pour les piscines hors sol en tôle. Se fixe simplement sur la tôle grâce à un aimant. Ils incorporent une télécommande très simple à utiliser. Technologie LED à faible consommation.

Faretto LED MULTICOLOR per piscina fuoriterra. Foglio adesivo con un magnete pronto all'uso. Include telecomando a distanza per un facile funzionamento. Risparmio energetico tecnologia al LED.



REF. PLED2

CS PACK 4



8 412081 250830

Conjunto de 2 proyectores LED BLANCOS para piscina elevada de acero. Fácil instalación, se pega a la chapa mediante un imán. Incorpora mando a distancia para fácil manejo. Tecnología Led de bajo consumo.

Set of 2 WHITE LED projectors for above ground pools. Stick to the sheet with a magnet and ready to use. Includes remote control for easy operation. Energy-saving LED technology.

Ensemble de 2 projecteurs LED pour piscine hors sol. Ils sont spécialement conseillé pour les piscines hors sol en tôle. Se fixe simplement sur la tôle grâce à un aimant. Il incorpore une télécommande très simple à utiliser. Technologie LED à faible consommation.

2 Faretto LED per piscina fuoriterra. Foglio adesivo con un magnete pronto all'uso. Include telecomando a distanza per un facile funzionamento. Risparmio energetico tecnologia al LED.

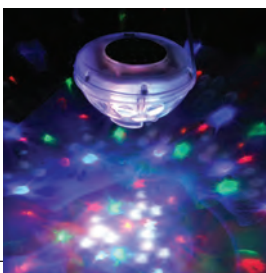

REF. 90173

CBX PACK 12



8 427370 901737

Lámpara fantasía
7 programas de luz diferentes.

Fancy lamp
7 different lighting programmes.

Lampe fantasie
sept jeux de lumière sur les parois et le fond de la piscine.

Lampada fantasia
sette giochi di luce differenti ai lati della piscina e sul fondo.



CALEFACCIÓN HEATING SYSTEMS CHAUFFAGE RISCALDAMENTO



Volumen max. Volume max	Max. volume Volume massimo	15 m ³	30 m ³	60 m ³	80 m ³	120 m ³
Referencia Référence	Reference Codice articolo	777590	777591	778375	778392	778393
Temperatura min/max Plage fonctionnement	Min/max temperature Temperature min.max	- 5 + 43 °C	- 5 + 43 °C	- 5 + 43 °C	- 5 + 43 °C	- 5 + 43 °C
Potencia calorífica Puissance de chauffage	Heating power Potenza di riscaldamento	3,5 Kw	5 Kw	8,7 Kw	12 Kw	24 Kw
COP COP	COP COP	5,8 W/W	5,6 W/W	6,0 W/W	6,0 W/W	6,0 W/W
Potencia enfriamiento Puissance refroidissement	Coolness power Potenza di raffreddamento	2,4 kW	3,3 kW	6,0 kW	8,0 kW	15,0 kW
Potencia de absorción Puissance absorbée	Absorption power Potenza assorbimento	0,6 kW	0,9 kW	1,45 kW	2 kW	2,6 kW
Compresor de rotación Hitachi. Rotation compressor of Hitachi. Compresseur à rotation Hitachi. Compressore di rotazione Hitachi						
Carga Charge	Charge Peso	800 g	800 g	1100 g	1200 g	2500 g
Alimentación eléctrica monofásica Alimentation électrique monophasée	Electrical source power single-phase Alimentazione elettrica monofase	220-240/50 V/Hz				
Conexión eléctrica Raccordement électrique	Electrical connection connessione elettrica	Toma tierra earth ground Avec terre messa a terra	Diferencial (no incluido) Dfferential (not included) Boite de dérivation (non fournie) differenziale(non incluso)			
Resistencia titanio Résistance en titane	Titanium resistance Resistenza in titanio	Titanio Titanium Titane Titano				
Flujo de salida mínimo Débit minimum à la sortie	Minimal flow of exit Flusso minimo in uscita	2,5m ³ /h	2,8m ³ /h	5,2m ³ /h	6,9m ³ /h	12m ³ /h
Conex Raccords	Conexión Connessione	50 mm				
Nivel de ruido del 1 al 10 Niveau sonore de 1 à 10 m	Sound level from 10m to 1m Livello sonoro da 1 a 10	35/42 dB(A)	35/44 dB(A)	36/45 dB(A)	36/45 dB(A)	47/56 dB(A)

Visualización de los parámetros de funcionamiento por pantalla LED. [Display of operating parameters through LED screen.](#)

Affichage des paramètres de fonctionnement par écran LED. [Visualizzazione dei parametri di funzionamento mediante LED](#)

Medida producto Dimensions l'appareil	Product size Misura prodotto	750 x 500 x 290 mm	750 x 500 x 325 mm	930 x 550 x 360 mm	1000 x 620 x 360 mm	1045 x 855 x 410 mm
Medida con caja Dimensions du carton	Packaging size Misura imballaggio	850 x 530 x 330 mm	855 x 530 x 330 mm	1060 x 600 x 380 mm	1065 x 670 x 380 mm	1140 x 955 x 430 mm
Peso net/bru Poids net/brut	Net/brut weight Peso net/brut	32/37 kg	37/42 kg	50/56 kg	65/72 kg	110/117 kg

Código EAN
Gencod

EAN Code
Codice a barrie





**CALEFACCIÓN SOLAR SOLAR HEATING SYSTEM
CHAUFFAGE SOLAIRE RISCALDAMENTO SOLARE**

Sistemas para calentamiento del agua de la piscina mediante la acción solar. Solar pool water heating systems.
Chauffage solaire pour piscine. Fabriqué en polyéthylène. Sistema per il riscaldamento dell'acqua della piscina per mezzo dell'azione del sole.



REF. AR2069 CBX PACK 1



Fabricado en polietileno. Aumenta la Temperatura del agua hasta 6°C. Mas de 12 kw/h de calor al dia. 600x60 cm. Peso 7 kg. Potencia de la bomba mínima recomendada: 1/3 CV.

Made of polythene. Water temperature can be increased up to 6 °C. 600x60 cm. Wight: 7 kg. Minimum recommended pump output: 1/3 hp.

Il augmente la température de l'eau jusqu'à 6°C. 600x60 cm. Poids 7 kg. Puissance de la pompe minimale recommandée: 1/3 CV.

In polietilene. Aumenta la temperatura dell'acqua fino a 6°C. 600x60 cm. Peso 7 kg. Potenza minima della pompa raccomandata: 1/3 CV.



REF. AR20693 CBX PACK 1



Calentador solar de agua para piscinas autoportantes. Fabricado con materiales flexibles (nylon y pvc). Medidas: 130x80 cm. Peso 1,2 kg. Aumenta la Temperatura del agua hasta 4°C. Funciona con bomba de piscina desde 2m³/h.

Solar pool water heating system for inflatable pools. Made of flexible materials (nylon and pvc). Dimensions: 130x80 cm. Weight: 1,2 kg. Water temperature can be increased up to 4°C. Minimum water volume: 2m³/h.

Rechauffeur solaire pour piscines autoportantes. Fabriqué avec des matériaux souples (nylon et pvc). Dimensions: 130x80cm. Poids 1,2 kg. Augmente la température de l'eau jusqu'à 4°C. Puissance de la pompe minimum recommandée: 2m³/h.

Sistema di riscaldamento solare di acqua per piscine autoportanti. Fabbriato con materiali flessibili (nylon e pvc). Misure: 130x80 cm. Peso 1,2 kg. Aumenta la temperatura dell'acqua fino a 4°C. Funziona con pompe da piscina da 2m³/h.



REF. 90230 CBX PACK 1



Permite aumentar la temperatura de su piscina por la acción del sol. Los calentadores pueden conectarse entre sí en serie. Aumenta la temperatura del agua 3°C en piscinas entre 7,5m³ y 10m³.

Solar pool water heating system. The heaters should be connected in series to heat the pool. Each solar heater increases the temperature of the swimming pool by 3°C due to solar action.

Système pour le chauffage solaire de l'eau de la piscine. Les réchauffeurs peuvent se connecter entre eux en série. Augmente la température de 3°C max. pour les piscines entre 7,5m³ et 10m³.

Permette di aumentare la temperatura della sua piscina tramite l'azione dei raggi solari. Ogni riscaldatore solare permette di aumentare la temperatura della piscina no a 3°C tramite l'azione naturale del sole.

DUCHAS SHOWERS DOUCHES DOCCIA



REF. DSALR32W
BXL PACK 1



Ducha solar redonda 32l
Aluminio aspecto madera
Con grifo lavapies

Round solar shower 32l
Aluminium Woodlike
With footwash tap

Douche solaire ronde 32l
Aluminium Aspect bois
Avec robinet lave pieds

Doccia solare round 32l
Alluminio Imitazione legno
Rubinetto lavapiedi



REF. DSALC32W
BXL PACK 1



Ducha solar cuadrada 32l
Aluminio Aspecto madera
Con grifo lavapies

Square solar shower 32l
Aluminium Woodlike
With footwash tap

Douche solaire carrée 32l
Aluminium Aspect bois
Avec robinet lave pieds

Doccia solare square 32l
Alluminio Imitazione legno
Rubinetto lavapiedi

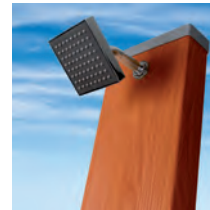

NEW



Ref. DSPS35
BXL PACK 1



Ducha solar 35l
PVC-Con grifo lavapies

Solar shower 35l
PVC. With footwash tap

Douche solaire 35l
PVC. Avec robinet
lave pieds

Doccia solare 35l
PVC. Rubinetto lavapiedi



Ref. AR1035W
BXL PACK 1



Ducha solar 35l
PVC aspecto madera

Solar shower 35l
Woodlike PVC

Douche solaire 35l
PVC Aspect bois

Doccia solare 35l
PVC Imitazione legno



REF. AR1130
BXL PACK 1



Ducha solar de jardín 32l
Aluminio
Con nebulizador y grifo
lavapies

Round solar shower 32l
Aluminium
With footwash tap

Douche solaire 32 litres
avec brumisateuse et
lave-pieds
Aluminium

Doccia solare 32l
Alluminio
Nebulizzatore e rubinetto
lavapiedi



REF. AR1035
BXL PACK 1



Ducha solar 38l - PVC
Douche solaire de jardin
38l - PVC

Garden solar shower
38l - PVC
Doccia solare 38l - PVC



REF. AR1030
BXL PACK 1



Ducha solar 30l
PVC
Douche solaire de
jardin 30l - PVC

Garden solar
shower 30l - PVC
Doccia solare 30l - PVC



REF. AR10250
BXL PACK 1



Ducha solar 20l
PVC
Douche solaire de
jardin 20l - PVC

Garden solar
shower 20l - PVC
Doccia solare 20l - PVC

complementos complements



REF. AR1020W

BXL PACK 1



8 412081 264387

Ducha solar 20l
PVC aspecto madera

Solar shower 20l
Woodlike PVC

Douche solaire 20l
PVC Aspect bois

Doccia solare 20l
PVC Imitazione legno



REF. 40664A

BXL PACK 1



8 427370 406645

Ducha solar 20l
PVC

Garden solar
shower 20l - PVC

Douche solaire de
jardin 20l - PVC

Doccia solare 20l - PVC



REF. AR1020P

BXL PACK 1



8 412081 240817

Ducha solar 20l - PVC

Garden solar shower
20l - PVC

Douche solaire de jardin
20l - PVC

Doccia solare 20l - PVC



REF. AR1009

BXL PACK 1



8 412081 264370

Ducha solar 9l - PVC

Garden solar shower
9l - PVC

Douche solaire de jardin
9l - PVC

Doccia solare 9l - PVC





REF. AR104

CBX PACK 6



8 4 12081 950716

Ducha aluminio. Fácil instalación y conexión

Aluminium shower. Easy installation and connection

Douche en aluminium. Montage et raccordement facile

Doccia alluminio. Facilità di installazione e collegamento



REF. DPE10

CBX PACK 12



8 4 12081 257501

Ducha para piscina sobre suelo. Con sistema de fijación al pasamanos de la escalera

Above-ground pool shower. With stair railings fixing system. No tools required

Douche pour piscine hors sol. Système de fixation à mâchoire universelle pour échelle tubulaire ou autres supports

Doccia per piscine fuori terra. Con sistema di fissaggio al corrimano della scaletta



REF. SBP4

CBX PACK 1



8 4 12081 268576

Base para ducha solar 60x60cm. Lamas imitación madera 4 piezas

Solar shower base 60x60cm Wood aspect slat 4 pieces

Socle pour douche solaire 60x60cm. Lattes aspect bois 4 parties

Base per doccia solare 60x60cm Listelli imitazione legno 4 parti



REF. LP01

PB PACK 12



8 4 12081 237695

Lavapiés

Footwash

Pédiluve

Lavapiedi

LOCAL TÉCNICO TECHNICAL ROOM LOCAL TECHNIQUE LOCALE TECNICO



DESIGNED,
MACHINED
AND
ASSEMBLED
IN EU

TECHNICAL ROOM

BXL PACK 1

LOCAL TÉCNICO

Pino silvestre autoclave clase III.
Paneles pre-ensamblados para montaje por usted mismo. Para todos los tipos de piscinas. Abertura superior mediante trampilla. Para adosar a la piscina o a una pared (con fondo).
L. 100 x a. 88 cm - 3 alturas disponibles.

LOCAL TECHNIQUE

En pin Sylvestre autoclave classe III.
Panneaux pré-assemblés, à monter soi-même. Pour tous types de piscines. Ouverture sur le dessus par une trappe. à adosser à la piscine ou à un mur (avec fond). L. 100 x l. 88 cm - 3 hauteurs disponibles.

TECHNICAL ROOM

Autoclave class III pine.
Pre-assembled panels for you to assemble yourself. For all types of swimming pools.
Top opening through a flap.
To fit to a pool or to a wall (with a base).
L 100 x h 88 cm - 3 heights available.

LOCALE TECNICO

Pino silvestre trattamento in autoclave classe III. Pannelli pre-assemblati che è possibile montare da soli. Per tutti i tipi di piscina. Apertura superiore mediante botola. Da appoggiare alla piscina o a una parete (con fondo).
L. 100 x a. 88 cm - 3 altezze disponibili.

Ref. 787247
H. 118cm



3 605217 872470

Ref. 787248
H. 131cm



3 605217 872487

Ref. 787249
H. 143cm



3 605217 872494

RACORDERÍA PVC FITTINGS RACCORDS PVC RACORDERIA IN PVC



REF. 40537
BX PACK 15



8 427370 405372

Enlace Ø 50 HXH PN16
PVC screw Ø 50 mm PN16
Raccord PVC Ø 50 HXH PN16
Raccordo Ø 50 HXH PN16



REF. 40538
BX PACK 20



8 427370 405389

Enlace 3P. Ø 50 macho 1" 1/2 PN16
PVC 3 piece union solvent socket
Ø50mm1"1/2
Raccord PVC en 3 parties Ø50 macho 1" 1/2
PN16
Raccordo 3P. Ø 50 maschio 1" 1/2 PN16



REF. 40539
BX PACK 15



8 427370 405396

Raccordo 3P. Ø 50 macho 2" PN16
PVC 3 piece union solvent socket Ø
50mm 2"
Raccord PVC en 3 parties Ø 50 macho
2" PN16
Raccordo 3P. Ø 50 maschio 2" PN16



REF. 40541
BX PACK 8



8 427370 405419

Válvula antiretorno Ø 50 PN16
Check valve Ø 50 mm
Valve anti-retour Ø 50 PN16
Valvola ritorno Ø 50 PN16



REF. 40543
BX PACK 6



Válvula Ø 50 PN10 PN10
PVC ball valve Ø 50 mm PN10
Valve anti-retour Ø 50 PN10
Valvola Ø 50 PN10 PN10



REF. 40555
BX PACK 10



Racord curva Ø 50 90° PN16
PVC elbow fitting 90° Ø 50 mm PN16
Valve anti-retour 90° Ø 50 PN16
Valvola 90° Ø 50 PN16



REF. 40590
BX PACK 30



Codo Ø 50 90° PN16 - para encolar
PVC 90° elbow solvent socket Ø 50 mm
Coude PVC à coller Ø 50 90° PN16
Gomito Ø 50 90° PN16 - da incollare



REF. 40591
BX PACK 40



Codo Ø 50 45° PN16
PVC 45° elbow solvent socket Ø 50 mm
Coude PVC Ø 50 45° PN16
Gomito Ø 50 45° PN16



REF. 40592
BX PACK 24



Te Ø 50 PN16 - para encolar
PVC-Tee 90° solvent socket Ø 50 mm
Raccord en T à coller Ø 50 PN16
Raccordo a T Ø 50 PN16 - da incollare



REF. 40593
BX PACK 60



Racord Ø 50 PN16 - para encolar
PVC union solvent socket Ø 50 mm
Raccord PVC à coller Ø 50 PN16
Raccordo Ø 50 PN16 - da incollare



REF. 40646
BX PACK 8



Válvula Ø50 PN10, manguito rosca macho
Ball valve Ø50 mm
Vanne Ø50 PN10 embout mal
Valvola Ø50 PN10, tubo filettato maschio



REF. 40553
BX PACK 12



Adhesivo para PVC 250 g
Blue Adhesive for flexible PVC pipes 250 g
Colle PVC 250gr
Adesivo per PVC 250 g

NEW



REF. 787104 **BX PACK 1**



Manguera semirígida reforzada, transparente, Ø38mm. 25m
Tuyau semi-rigide reforcé, Transparent, Ø38mm. 25m
Semi-rigid reinforced hose, transparent, Ø38mm. 25m
Tubo semirigido inforzato, trasparente, Ø38mm. 25m



REF. 40557 **PB PACK 1**



Tubo PVC semirígido Ø 50, 25m
Couronne PVC semi-rigide Ø 50, 25m
Semi-rigid PVC hose Ø 50 mm, 25m
Tubo PVC semirígido Ø 50, 25m



Leyenda Legend Légende Legenda

BX

caja
box
box
scatola

BXL

caja con etiqueta
box and label
carton avec étiquette
scatola con etichetta

CB

cartoncillo
cardboard wrap
bande carton
cartone

CBX

caja litografiada
colour box
boîte de couleur
scatola serigrafata

PB

bolsa de plástico
polybag
sac plastique
busta di plastica

PBH

bolsa de plástico con cartoncillo
polybag with header
sac plastique avec bande carton
sacchetto di plastica con cartone

BL

blisters
blister
blister
blister

CS

doble burbuja
clamshell
double coque
doppio rivestimento

DIS

display
display
display
display



manguera
hose
tuyau
tubo



cable
wire
câble
cavo

material de cleaning limpieza material

MATERIAL DE LIMPIEZA	121	CLEANING MATERIAL
Robots	122	Robots
Limpiafondos eléctricos	126	Electric cleaners
Limpiafondos automáticos	128	Automatic cleaners
Limpiafondos de aspiración	131	Vacuum cleaners
Kits limpiafondos	132	Vacuum cleaners kits
Limpiafondos Ventury	133	Ventury vaccum
Gama confort	134	Confort range
Gama Superluxe	136	Superluxe range
Limpiafondos manuales	137	Vacuum heads
Recogehojas	138	Leaf nets and rakes
Cepillos	139	Brushes
Termómetros	140	Thermometers
Mangos telescópicos	141	Telescopic handles
Dosificadores	142	Dispensers
Cardboard range	143	Cardboard range
ECO	147	ECO range
Espónjas	150	Sponges
Protección invierno	151	Winter protection
Mangueras flotantes	152	Vacuum hoses

matériel de nettoyage materiale di pulizia

MATÉRIEL DE NETTOYAGE	121	MATERIALE DI PULIZIA
Robots	122	Robots
Nettoyeurs de fond électriques	126	Pulitore elettrico
Nettoyeurs automatiques	128	Puliscifondi automatici
Nettoyeurs pour aspiration	131	Pulitore fondo ad aspirazione
Kit nettoyeurs	132	Kit Pulitore fondo
Aspirateurs de fond ventury	133	Puliscifondi Ventury
Gamme confort	134	Gamma confort
Gamme Superluxe	136	Gamma Superluxe
Balais manuels	137	Puliscifondo manuale
Époussettes	138	Raccoglitori
Brosses	139	Spazzole
Thermomètres	140	Termometri
Manches télescopiques	141	Manico telescopico
Doseurs	142	Dosatori
Cardboard range	143	Cardboard range
ECO	147	ECO
Eponges	150	Spugne
Protection hiver	151	Protezione inverno
Tuyaux flottants	152	Tubi galleggianti

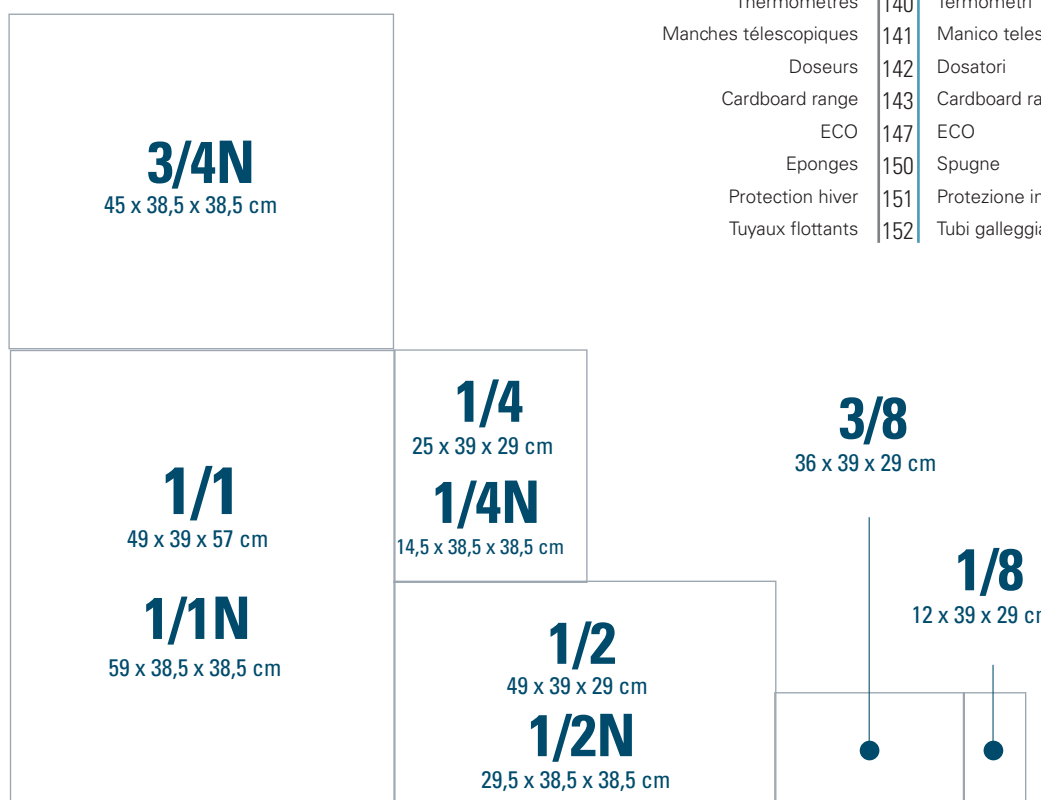

material de limpieza

cleaning material

ROBOTS ROBOTS
ROBOTS ROBOTS



KAYAK FUTURE REMOTE CONTROL

REF. RKFA100CR

18 m

CBX PACK 1



El Kayak Future CR se adapta a todo tipo de piscinas hasta 120m² de superficie y limpia el fondo, las paredes y la línea de agua de su piscina.

Le robot Kayak Future RC convient pour tout type de piscine d'une superficie jusqu'à 120 m². Il nettoie le fond, les parois ainsi que la ligne d'eau.

The Kayak Future CR adapts to all types of pools measuring up to 120m² in surface area, cleaning the bottom, walls and water line.

Il Robot Kayak Future CR si adatta a tutti i tipi di piscine fino a 120m² di superficie, pulendo il fondo, le pareti e linea dell'acqua.

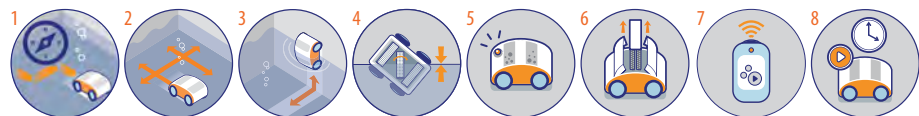

KAYAK FUTURE

REF. RKFA100

18 m

CBX PACK 1



El Kayak Future se adapta a todo tipo de piscinas hasta 120m² de superficie y limpia el fondo, las paredes y la línea de agua de su piscina.

Le robot Kayak Future convient pour tout type de piscine d'une superficie jusqu'à 120 m². Il nettoie le fond, les parois ainsi que la ligne d'eau.

The Kayak Future adapts to all types of pools measuring up to 120m² in surface area, cleaning the bottom, walls and water line.

Il Robot Kayak Future si adatta a tutti i tipi di piscine fino a 120m² di superficie, pulendo il fondo, le pareti e linea dell'acqua.



- 1. GYRO:** Nuevo Sistema de Navegación Giroscópica que maximiza el ciclo de lavado y evita que el cable se enrede **New Gyroscopic Navigation System to improve navigation of the robot, maximize efficacy and prevent cable tangling** Nouveau système de navigation qui maximise le cycle de lavage et empêche câble enchevêtrement **Nuovo sistema di navigazione che massimizza il ciclo di lavaggio e previene l'aggraviamento del cavi**
- 2. Aquasmart System:** Algoritmo patentado para limpiar la piscina en menos tiempo **Patented algorithm for covering a pool with less time** La fonction Aquasmart est un algorithme permettant un nettoyage plus rapide et plus efficace **Algoritmo certificato per pulire una piscina in minor tempo**
- 3. Floor & Walls:** Limpia el suelo y las paredes de la piscina **Cleans the bottom and walls** Nettoie le fond et les parois de la piscine **Pulisce fondo e pareti della piscina**
- 4. Water line:** Limpia la línea de flotación **Cleans the water line** Nettoyage de la ligne d'eau **Pulisce la linea dell'acqua**
- 5. Filter check:** Indicador de filtro lleno mediante LED **Full filter LED indicator** Indicateur LED dans le transformateur indiquant que le filtre est plein **Indicatore filtro pieno mediante un LED luminoso**
- 6. Top access:** Filtro de acceso superior **Top access filter** Filtre facile à nettoyer avec le système top access **Accesso al filtro nella parte superiore del robot**
- 7. Remote Control:** Con mando a distancia **With easy remote control** Télécommande de contrôle **Telecomando a distanza**
- 8. Timer:** Ciclo de limpieza programable **Programmable cleaning cycle** Cycle de nettoyage programmable **Ciclo di pulizia programmabile**

matériel de nettoyage materiale di pulizia



TRACK 4x4

REF. R44SP

18 m

CBX PACK 1



El Track 4x4 se adapta a todo tipo de piscinas hasta 90m² de superficie y limpia el fondo, las paredes y la línea de agua de su piscina.

The Track 4x4 adapts to all types of pools measuring up to 90m² in surface area, cleaning the bottom, walls and water line.

Le robot Track 4x4 convient pour tout type de piscine d'une superficie jusqu'à 90 m². Il nettoie le fond, les parois ainsi que la ligne d'eau.

Il Robot Tracks 4x4 si adatta a tutti i tipi di piscine fino a 90m² di superficie, pulendo il fondo, le pareti e linea dell'acqua.



KAYAK ADVENTURE

REF. RKA80

18 m

CBX PACK 1



El Kayak Adventure se adapta a todo tipo de piscinas hasta 100m² de superficie y limpia el fondo, las paredes y la línea de agua de su piscina.

The Kayak Adventure adapts to all types of pools measuring up to 100m² in surface area, cleaning the bottom, walls and water line.

Le robot Kayak Adventure convient pour tout type de piscine d'une superficie jusqu'à 100m². Il nettoie le fond, les parois ainsi que la ligne d'eau.

Il Robot Kayak Adventure si adatta a tutti i tipi di piscine fino a 100m² di superficie, pulendo il fondo, le pareti e linea dell'acqua.

1. **GYRO:** Nuevo Sistema de Navegación Giroscópica que maximiza el ciclo de lavado y evita que el cable se enrede **New Gyroscopic Navigation System to improve navigation of the robot, maximize efficacy and prevent cable tangling** Nouveau système de navigation qui maximise le cycle de lavage et empêche câble enchevêtrement **Nuovo sistema di navigazione che massimizza il ciclo di lavaggio e previene l'aggraviamento dei cavi**
2. **Floor & Walls:** Limpia el suelo y las paredes de la piscina **Cleans the floor and the wall of the pool** Nettoie le fond et les parois de la piscine **Pulisce fondo e pareti della piscina**
3. **Top access:** Filtro de acceso superior **Top access filter** Filtre facile à nettoyer avec le système top access **Acceso al filtro nella parte superiore del robot**
4. **Max scrubber:** Cepillo rotativo de gran velocidad **Fast moving brush** Brosse rotative de grande vitesse **Spazzola rotante di grande velocità**
5. **Easy view:** Ventana transparente para ver el filtro **Transparent window for seeing inside the filters** Système easy view pour avoir un aperçu sur le niveau de remplissage du filtre **Finestrella trasparente per controllare meglio la situazione del filtro**
6. **4x4:** Tecnología 4x4 patentada con un sólo motor de tracción **4x4 patented technology with only one drive motor** Système de traction 4x4 breveté avec 1 seul moteur pour une longévité accrue **Tecnología 4x4 brevettata con un solo motore di trazione**
7. **Plug&Play:** Conectar y listo para usar **Put the robot in the water and it's ready to clean** Prêt à fonctionner **Una volta collegato è pronto per lavorare**
8. **Easy clean:** Filtro fácil y rápido de limpiar **Filter that enables quick and easy cleaning** Facilité d'accès pour nettoyer le robot **Filtro facile e rapido da pulire**
9. **Light:** Robot ligero **Light robot** Robot léger **Leggero**
10. **Filter check:** Indicador de filtro lleno mediante LED **Full filter LED indicator** Indicateur LED dans le transformateur indiquant que le filtre est plein **Indicatore filtro pieno mediante un LED luminoso**
11. **Cl₂:** Con generador automático de cloro mediante sal **With automatic chlorine generator by salt** Avec générateur automatique du chlore avec le sel **Genera automaticamente cloro mediante il sale**

material de limpieza

cleaning material

KAYAK ADVENTURE COMPACT

REF. RKA80C

15 m

CBX PACK 1



El Kayak Adventure Compact se adapta a todo tipo de piscinas hasta 100m² de superficie. Limpia el fondo y las paredes de su piscina.

Le robot Kayak Adventure Compact convient pour tout type de piscine d'une superficie jusqu'à 100m². Il nettoie le fond et les parois.

The Kayak Adventure Compact adapts to all types of pools measuring up to 100m² in surface area, cleaning the bottom and walls.

Il Robot Kayak Adventure Compact si adatta a tutti i tipi di piscine fino a 100m² di superficie, pulendo il fondo e le pareti.

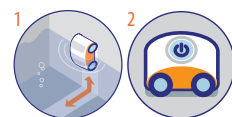

- 1. Floor & Walls:** Limpia el suelo y las paredes de la piscina Cleans the bottom and walls Nettoie le fond et les parois de la piscine Pulisce fondo e pareti della piscina
2. Plug&Play: Conectar y listo para usar Put the robot in the water and it's ready to clean Prêt à fonctionner Una volta collegato è pronto per lavorare

TRACK 1

REF. RT1S

15 m

CBX PACK 1



El Track 1 se adapta a todo tipo de piscinas hasta 60m² de superficie y limpia el suelo y la media caña de piscinas con borde curvo.

Le Track 1 s'adapte à toutes les piscines de jusqu'à 60m² de surface et il permet de nettoyer le fond et les bords arrondis des piscines.

The Track 1 adapts to all types of pools measuring up to 60m² in surface area, cleaning the floor and the half tube with curved edge.

Il Track 1 si adatta a tutte le tipologie di piscine fino a 60m² di superficie e pulisce il fondo e le stonature delle pareti delle piscine a bordo curvo.

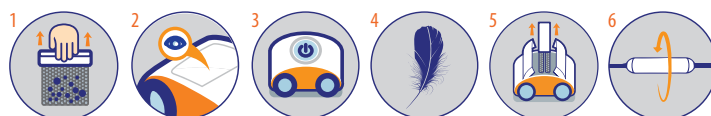

- 1. Easy clean:** Filtro fácil y rápido de limpiar Filter that enables quick and easy cleaning Facilité d'accès pour nettoyer le robot Filtro facile e rapido da pulire
2. Easy view: Ventana transparente para ver el filtro Transparent window for seeing inside the filters Système easy view pour avoir un aperçu sur le niveau de remplissage du filtre Finestrella trasparente per controllare meglio la situazione del filtro
3. Plug&Play: Conectar y listo para usar Put the robot in the water and it's ready to clean Prêt à fonctionner Una volta collegato è pronto per lavorare
4. Light: Robot ligero Light robot Robot léger Leggero
5. Top access: Filtro de acceso superior Top access filter Filtre facile à nettoyer avec le système top access Accesso al filtro nella parte superiore del robot
6. Anti-tangle system: Sistema anti-enredo para un funcionamiento óptimo With anti-tangle system allowing optimal performance Système « anti-emmêlement » pour un rendement optimal Sistema "anti-impigliamento" che consente un'ottima resa

matériel de nettoyage materiale di pulizia



KAYAK CLEVER

REF. RKC100J

12 m

CBX PACK 1



El Kayak Clever limpia el fondo inclinado o plano de piscinas hasta 60m² de superficie.

The Kayak Clever adapts to all types of pools measuring up to 60m² in surface area, cleaning the bottoms whether they are flat or inclined.

Le robot Kayak Clever RKC100J convient pour tout type de piscine à fond plat ou pente douce d'une superficie jusqu'à 60m².

Il Robot Kayak Clever RKC100J si adatta a tutti i tipi di piscine fino a 60m² di superficie, pulendo il fondo in piano che inclinato.



KAYAK JET BLUE

REF. RKJ14

12 m

CBX PACK 1



El Kayak Jet Blue limpia el fondo inclinado o plano de piscinas hasta 60m² de superficie.

The Kayak Jet Blue adapts to all types of pools measuring up to 60m² in surface area, cleaning the bottoms whether they are flat or inclined.

Le robot Kayak Jet Blue convient pour tout type de piscine à fond plat ou pente douce d'une superficie jusqu'à 60m².

Il Robot Kayak Jet Blue si adatta a tutti i tipi di piscine fino a 60m² di superficie, pulendo il fondo in piano che inclinato.



1. **Plug&Play:** Conectar y listo para usar Put the robot in the water and it's ready to clean Prêt à fonctionner Una volta collegato è pronto per lavorare
2. **Light:** Robot ligero Light robot Robot léger Leggero
3. **Top access:** Filtro de acceso superior Top access filter Filtre facile à nettoyer avec le système top access Accesso al filtro nella parte superiore del robot

RECAMBIOS BOLSA FILTRANTE SPARE FILTRATION BAGS RECHARGES SAC POUR ROBOTS RICAMBI SACCO FILTRO

Recambio de bolsa filtrante textil - reutilizable - lavable
Recharge sac textile pour Robot Kayak - Réutilisable - Lavable

Spare filtration bag - 1 unit. Reusable - Washable
Busta per Robot Kayak - textil - scatola di 1 unità. Riutilizzabile - Lavabile



REF. 40683

PB pack 2



3 bolsas recambio desechables para robot
Sac jetable pour robot - carton de 3 pièces

Non-returnable spare filtration bag - 3 units
Busta per robot usa e getta - scatola di 3 unità

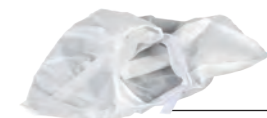

REF. 40684

CBX pack 8



LIMPIAFONDOS ELÉCTRICOS ELECTRIC CLEANERS

NETTOYEUR DE FOND ÉLECTRIQUE PULITORE ELETTRICO PER FONDO PISCINA

Los limpiafondos eléctricos son una solución cómoda y sencilla para la limpieza de la piscina. Son recargables, sin necesidad de cables y muy manejables debido a su tamaño y forma.

Electric cleaners are a convenient and simple solution for cleaning the pool. They are rechargeable, wirelessly and very manageable because of its size and shape.



ELECTRIC VAC PLUS

REF. VCB50

CBX PACK 4



8 412081 272528

Limpiafondos eléctrico autónomo - Potencia: 36 W. Se puede utilizar con su propio mango o conectado a un mango telescópico estándar para facilitar su uso en piscinas más profundas. Recargable, sin cables. Incluye 3 baterías recargables litio (4000mah/11,1V). Potencia de succión: 90 l/h. Tiempo de trabajo: 90 minutos. Ligero, fácil de manejar.

Autonomous electric cleaner – Power: 36 W. Can be used with its own handle or connected to a standard telescopic handle for ease use in deeper pools. Rechargeable, without cables. It includes 3 rechargeable lithium batteries (4000mah/11.1V). Suction power: 90 l/h. Working time: 90 minutes. Lightweight, easy to handle.

Nettoyeur électrique autonome -Puissance: 36 W. Il peut être utilisé avec sa propre poignée ou attaché à une poignée télescopique standard pour faciliter son utilisation dans des bassins plus profonds. Rechargeable, sans câbles. Comprend 3 batteries rechargeables au lithium (4000mah / 11.1V). Puissance d'aspiration: 90 l / h. Temps de travail: 90 minutes. Léger, facile à manipuler.

Pulitore elettrico autonomo - Potenza: 36 W. Si può usare con il manico in dotazione o collegato ad un'asta telescopica per agevolare il suo utilizzo in piscine più profonde. Ricaricabile, senza cavo. Include 3 batterie ricaricabili litio. (4000mah/11,1V). Potenza di assorbimento: 90 l/h. Tempo di lavoro: 90 minuti. Leggero, facile da maneggiare.



ELECTRIC VAC

REF. VCB10

CBX PACK 4



8 412081 263298

Especialmente indicado para piscinas enterradas, limpia las escaleras y esquinas donde el limpiafondos automático no llega. Posee un depósito removible de gran capacidad e incorpora un filtro que retiene partículas de pequeño tamaño. Ligero y de fácil manejo. Recargable y sin cables: funciona con batería de litio recargable de 11,1 V. Posibilidad de uso con su propio asa o conectándolo a una pértiga.

Especially indicated for embedded pools, cleans stairs and corners where automatic cleaners do not reach. It has a large capacity removable tank and includes a filter to retain small- size particles. Lightweight and easy to use. Rechargeable and without cables: operates with an 11.1 V lithium battery. Possibilities of use with its own handle or connected to a pole.

Spécialement conçu pour les piscines enterrées. Il nettoie les escaliers et les angles, contrairement au nettoyeur de fond automatique. Il est muni d'un réservoir amovible de grande capacité et il incorpore un filtre qui retient les particules de petite taille. Léger et facile à manipuler. Rechargeable et sans câbles : il fonctionne avec un accumulateur lithium rechargeable de 11,1 V. Il peut être utilisé avec sa poignée ou bien connecté à une perche.

Particolarmente indicato per piscine interrate, pulisce le scalette e gli angoli che il pulitore automatico non riesce a raggiungere. È dotato di un capiente serbatoio removibile e di un filtro in grado di trattenere le particelle più piccole. Leggero e maneggevole. Ricaricabile e senza fili: funziona con batteria al litio ricaricabile da 11,1V.

matériel de nettoyage materiale di pulizia

Les nettoyeurs de fond électriques sont une solution pratique et simple pour le nettoyage des piscines. Ils sont rechargeables, sans besoin de câbles et très faciles à utiliser en raison de leur taille et de leur forme.

I pulitori elettrici per fondo piscina rappresentano una soluzione comoda e semplice per la pulizia della piscina. Sono ricaricabili, non necessitano di cavi e sono maneggevoli grazie alle loro dimensioni e alla forma.



POOL & SPA VAC

REF. CSPA

CBX PACK 6



8 412081 265315

Limpiafondos para piscinas y spas con mango. Recargable y sin cables. Posibilidad de uso con su propio mango o conectado a una pértiga. Ligero y manejable.

Nettoyeur de fonds pour piscines et spas avec manche. Rechargeable et sans câbles. Il peut être utilisé avec sa poignée ou bien connecté à une perche. Léger et facile à manipuler.

Pool and spa vac with handle. Rechargeable and without cables. Possibilities of use with its own handle or connected to a pole. Lightweight and easy to use.

Pulitore per fondo piscina e spa con manico. Ricaricabile e senza fili. Può essere utilizzato con il manico in dotazione o collegato a un'asta.



STICK VAC

REF. VCB08

CBX PACK 6



8 412081 272535

Limpiafondos eléctrico para piscinas y Spa. Limpiador eléctrico autónomo - Potencia: 10 W. Sin cables. Necesita 8 baterías AA. Poste de extensión de 1,65 m incluido. Peso ligero, fácil manejo. Sin cables.

Nettoyeur de piscine et de spa électrique. Nettoyeur électrique autonome - Puissance: 10 W. Sans câbles. Nécessite 8 piles AA. Poste d'extension de 1,65 m inclus. Poids léger, manipulation facile. Pas de câbles.

Pool and spa electric cleaner. Autonomous electric cleaner. Power: 10 W. Without cables. 8 pieces of AA battery needed. Extension pole of 1,65 m included. Lightweight, easy to handle. Without cables.

Pulitore elettrico per piscine e Spa. Pulitore elettrico autonomo - Potenza: 10 W. Senza cavo. Necessita di 8 batterie AA. Asta estensibile di 1,65 m inclusa. Peso leggero, facile da maneggiare. Senza cavi.

LIMPIAFONDOS AUTOMÁTICOS AUTOMATIC CLEANERS NETTOYEURS AUTOMATIQUES PULISCIFONDI AUTOMATICI

WHEELS VAC

REF. SC600

10m - Ø 38

CBX PACK 1



8 412081 272580



Limpiafondos programado. Baja potencia. Funciona con bomba 0,25 CV (180W). Incluye 10m de manguera. Especial para esquinas y peldaños. Fácil instalación y mantenimiento

Nettoyeur programmé. Faible puissance. Fonctionne avec une pompe de 0,25 CV (180W). 10m de tuyau inclus. Spécial pour les coins et les marches. Installation et maintenance facile.

2 Wheels suction cleaner
Programmed cleaning. Low flow requirement. It works with 0,25 CV (180W) pumps. Includes 10m of hose. Specially design to work in corners and steps. Easy installation and maintenance

Pulitore programmato. Bassa potenza. Funziona con pompa 0,25 CV (180W). Inclusi 10m di tubi. Speciali per angoli e scalini. Facile installazione e manutenzione.



ACROBAT

REF. ACD10

9m - Ø 38

CBX PACK 1



8 412081 268477

Limpiafondos automático de membrana. Limpia el fondo y las paredes de cualquier piscina. Funciona con sistemas de filtración de una potencia mínima de 1/2CV.

Nettoyeur automatique avec système unique de membrane. Nettoie le fond et les parois de la piscine. Il fonctionne avec des systèmes de filtration d'une puissance minimum de 1/2cv.

Automatic pool cleaner with membrane system. The Professional Vac cleans the bottom and walls of your pool. Works with 1/2 hp minimum.

Puliscifondo automatico con sistema a membrana. Il Professional Vac pulisce il fondo e le pareti della piscina. Funziona con sistemi di filtrazione che hanno una potenza minima di 1/2cv.



PROFESSIONAL VAC

REF. 19007

9,6m - Ø 38

CBX PACK 1



8 427370 190070

Limpiafondos automático de membrana. Limpia el fondo y las paredes de cualquier piscina. Funciona con sistemas de filtración de una potencia mínima de 0,33CV.

Nettoyeur automatique avec système unique de membrane. Nettoie le fond et les parois de la piscine. Il fonctionne avec des systèmes de filtration d'une puissance minimum de 0,33cv.

Automatic pool cleaner with membrane system. The Professional Vac cleans the bottom and walls of your pool. Works with 0,33 hp minimum.

Puliscifondo automatico con sistema a membrana. Il Professional Vac pulisce il fondo e le pareti della piscina. Funziona con sistemi di filtrazione che hanno una potenza minima di 0,33cv.



matériel de nettoyage materiale di pulizia



Max. 1,80m



SILENCE VAC

REF. 90397

9,6m - Ø 38

CBX PACK 2



8 427370 903977

Limpiafondos automático más silencioso que los sistemas tradicionales de "martillo". Limpia el fondo y las paredes de su piscina. Funciona con sistemas de filtración de una potencia mínima de ½cv y máxima de 1½cv.

Automatic pool cleaner which is quieter than the traditional "hammer" systems. The Silence Vac cleans the bottom and walls of your pool. Works with ½ hp minimum and 1½hp maximum power filtration systems.

Nettoyeur automatique plus silencieux que les systèmes traditionnels à "marteau". Nettoie le fond et les parois de la piscine. Il fonctionne avec des systèmes de filtration d'une puissance minimum de ½cv et maximale de 1½cv.

Puliscifondo automatico più silenzioso dei sistemi tradizionali a "martello". Il Silence Vac pulisce il fondo e le pareti della piscina. Funziona con sistemi di filtrazione che hanno una potenza minima di ½cv e massima di 1½cv.



CLASSIC VAC

REF. 19001

8m - Ø 38

CBX PACK 1



8 427370 190018

Limpiafondos automático para piscinas enterradas y elevadas dotadas de un equipo de filtración con una bomba de una potencia mínima de 3/4 cv.

Automatic pool cleaner for in ground and above ground pools equipped with filtering equipment with a minimum power pump of 3/4 hp.

Nettoyeur automatique de piscines enterrées et hors-sol équipé d'une filtration avec une pompe d'une puissance minimum de 3/4cv.

Puliscifondo automatico per piscine interrate e fuori terra dotate di un sistema di filtrazione con una potenza minima di 3/4 cv.

material de limpieza

cleaning material

WIKI VAC

REF. 90399

6m - Ø 32

CBX PACK 2



Limpiafondos automático para piscinas autoportantes y elevadas. Funciona con equipos de filtración de baja potencia: a partir de 0,1cv. Dispone de un prefiltro exclusivo que permite proteger el cartucho y la filtración.

Nettoyeur automatique pour piscines autoportantes et hors-sol. Il fonctionne avec des filtrations de très faible puissance: à partir de 0,1cv minimum. Il dispose d'un préfiltre exclusif qui protège la cartouche et la filtration.

The automatic pool cleaner for inflatable or above ground pools. Works with low-power filtering equipment: ranging from 0.1hp. It has a unique pre-filter which protects the cartridge and filtration.

Puliscifondo per piscine autoportanti e fuoriterra. Funziona con un sistema di filtrazione a partire da 0,1 cv di potenza. E' dotato di un prefiltro esclusivo che permette una maggior cura della cartuccia e della filtrazione.



SMALL CONFORT

REF. AR20682

6m - Ø 32

CBX PACK 4



Limpiafondos automático por aspiración. Se conecta directamente al skimmer y es compatible con bombas a partir de 1/3CV.

Nettoyeur de fond automatique par aspiration. Il se branche directement sur le skimmer et il est compatible avec des pompes à partir de 1/3 de CV.

Automatic suction pool cleaner that is directly connected to the skimmer. Compatible with pumps from 1/3HP.

Puliscifondo automatico ad aspirazione. Si collega direttamente allo skimmer ed è compatibile con pompe a partire da 1/3CV.



matériel de nettoyage materiale di pulizia

LIMPIAFONDOS DE ASPIRACIÓN MANUAL VACUUM CLEANERS NETTOYEURS ASPIRANTS PULITORI AD ASPIRAZIONE MANUALE

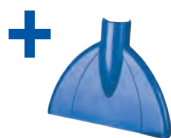

MEDIUM VAC

REF. AR20637

9m - Ø 32

CBX PACK 6



8 412081 231099

Kit de mantenimiento para piscinas autoportantes o elevadas. Contiene dos boquillas (una de ellas con cepillo).

Le Kit d'entretien pour piscines autoportantes ou hors-sol. Contient: un aspirateur de fond à aspiration manuelle qui inclut deux embouts.

Maintenance kit for inflatable or above ground pools. The pool cleaner includes: two suction nozzles, one with a brush.

Kit di mantenimento per piscine autoportanti o fuori terra. Contiene due aspiratori, uno con pennello



LITTLE VAC

REF. 08011A

5m - Ø 32

CBX PACK 6



8 427370 080111

Kit de mantenimiento para piscinas autoportantes o elevadas.

Le Kit d'entretien pour piscines autoportantes ou hors-sol.

Maintenance kit for inflatable or above ground pools.

Kit di mantenimento per piscine autoportanti o fuori terra.



REF. PSV51

CBX PACK 6



8 412081 250137

Pool & Spa Vac: Limpiafondos manual con accesorios Incluye: recogedor superficie, boquilla ancha aspiración, cepillo acoplable, soporte para pared.

Pool & Spa Vac: Nettoyeur de fond manuel avec accessoires Il inclut: un ramasseur de surface, un bec large d'aspiration, une brosse et un support pour le mur.

Pool & Spa Vac: Includes: Leaf net+ Suction nozzle+ Attachable brush + Wall bracket.

Pool & Spa Vac: Puliscifondo manuale con accessori Include: rete foglie, bocchetta di aspirazione, spazzola, staffa per muro.

KITS LIMPIAFONDOS VACUUM CLEANER KITS

KIT NETTOYEUR ASPIRANTS KIT PULITORI FONDO AD ASPIRAZIONE

REF. AR20641

CBX PACK 2



Limpiafondos para pértiga + pértiga 3 secciones + recogedor de fondo + termómetro flotante + dosificador oval + cepillo para liner + manguera 6m + bote de tiras reactivas (tester)

Pack d'entretien comprenant: un nettoyeur de fond pour manche + perche 3 sections + epuisette de fond + thermomètre flottant + doseur ovale pour galets de 200gr + brosse pour liner + 6m tuyau + boîte de bandelettes de test (tester)

Bottom cleaner for pole + 3 section pole + leaf rake + floating thermometer + oval dispenser + brush for liner + 6m hose + can of reactive test strips (tester)

Puliscifondi + pertica 3 sezioni + raccogliore di fondo + termometro galleggiante + dosatore ovale + spazzola per liner + 6m tubo + confezione da striscie reattive (tester)



REF. AR2064

CBX PACK 4



Kit limpiafondos + pértiga 3,60m (3x1,20m) + manguera 6m

Kit nettoyeur + manche 3,60m (3x1,20m) + tuyau 6m

Vacuum head kit + handle 3,60m (3x1,20m) + 6m hose

Kit puliscifondo + pertica 3,60m (3x1,20m) + tubo 6m



REF. KMA05

CS PACK 6



Kit mantenimiento piscinas: analizador pH/Cl, cepillo 45 cm, recogehojas superficie, termómetro y limpiafondos

Kit de nettoyage pour piscines: analyse pH/Cl, brosse 45 cm, époussette de surface, thermomètre et balai manuel

Pool maintenance kit: pH/Cl Test kit, 45 cm Brush, leaf net, thermometer and Vacuum head

Kit di mantenimento per piscine: analizzatore ph/cl, spazzola 45 cm, raccogliore di superficie, termometro e puliscifondo



REF. KMSPA

CS PACK 6



Kit mantenimiento para spa hinchable o rígido. Incluye: Recogehojas · cepillo · Limpiador de cartuchos

Kit d'accessoires pour spa gonflable ou rigide. Le kit comprend: Une époussette · Une brosse · Un nettoyeur de cartouche

Maintenance kit for Inflatable and rigid spas. Includes: Leaf skimmer · Brush · Filter cartridge cleaner

Mantenimento per spa gonfiabili o parete rigida. Include: Raccogliore · Spazzola · Pistola per pulire le cartucce



LIMPIAFONDOS VENTURY VENTURY VACUUM ASPIRATEURS DE FOND VENTURY PULISCIFONDI VENTURY



REF. 08050

CS PACK 6



8 427370 080500

Kit piscina autoportante: analizador pH/Cl, cepillo, recogehojas de superficie, mango 1,20m (3 tramos) termómetro tubular, dosificador y jet vac ventury.

Special inflatable pool kit: pH/chlorine test kit, brush, leaf net, tubular thermometer, 1,20m handle (3 sections), fl oating dispenser and ventury vacuum.

Kit spécial piscine autoportante: trousse d'analyse pH/Cl, brosse, époussette de surface, manche 1,20m (3 parties), thermomètre tubulaire, doseur pastilles rétractable and jet vac ventury.

Kit speciale per piscina autoportante: analizzatore pH/Cl, spazzola, Raccogliatore di superficie, manico 1,20m (3 sezioni) termometro tubolare, dosatore e aspiratore jet vac ventury.



REF. 90111

DIS 3/4N PACK 8



8 427370 901119

Limpiafondos Micro-Ventury.
Nettoyeur Micro-Venturi.

Micro-Ventury Vacuum.
Puliscifondi Micro-Ventury.



REF. Y15

CBX PACK 12



8 412081 201214

Kit limpiafondos Ventury+ pértiga.
Kit Aspirateur de fond Venturi + manche.

Ventury vacuum kit + handle.
Aspiratore Ventury+ pertica.



REF. Y10

CBX PACK 6



8 412081 890180

Limpiafondos Ventury+ pértiga
Aspirateur de fond Venturi + manche.

Ventury vacuum + handle.
Aspiratore Ventury+ pertica.



REF. Y12

CS PACK 50



8 412081 940861

2 filtros para limpiafondos ventury
2 filtres pour aspirateur de fond

2 filters for ventury bottom cleaner
2 filtri per puliscifondo venturi

material de limpieza

cleaning material

GAMA CONFORT CONFORT RANGE
GAMME CONFORT GAMMA CONFORT

Recogehojas de superficie
Gama confort
Époussette de surface
Gamme confort

Confort range
Leaf net
Raccoglitore di superficie
Gamma confort



NEW



REF. 40030N

DISPACK 12



8 4 1 2 0 8 1 2 7 2 9 6 2

Recogehojas de fondo
Gama confort
Époussette de fond
Gamme confort

Confort range
leaf rake
Raccoglitore di fondo
Gamma confort



REF. 40032N

DIS PACK 12



8 4 1 2 0 8 1 2 7 2 9 5 5

Recogehojas superficie
aluminio
Époussette de surface
aluminium

Aluminium
Leaf net
Raccoglitore di superficie
alluminio



REF. RHSALN

DIS PACK 12



8 4 1 2 0 8 1 2 7 2 9 7 9

Recogehojas fondo
aluminio
Époussette de fond
aluminium

Aluminium
Leaf rake
Raccoglitore di fondo
alluminio



REF. RHFALN

DIS PACK 12



8 4 1 2 0 8 1 2 7 2 9 8 6

Termómetro UFO
Thermomètre UFO

UFO thermometer
Termometro UFO



REF. TTUFO

DIS PACK 12



8 4 1 2 0 8 1 2 7 3 0 6 8

Colgador metálico para
material de limpieza
Cintre en métal pour le
rangement du matériel

Metalic hanger for
cleaning material
Portautensili metallico per
attrezzi di pulizia



REF. BHM5

DIS PACK 6



8 4 1 2 0 8 1 2 7 3 0 7 5

matériel de nettoyage materiale di pulizia

NEW



Cepillo 45 cm
Brosses 45 cm

45 cm brushes
Spazzole 45 cm

REF. 40041N

DIS PACK 12



8 4 1 2 0 8 1 2 7 3 0 1 3



Cepillo 25 cm
Brosses 25 cm

25 cm brushes
Spazzole 25 cm

REF. 40041SN

DIS PACK 12



8 4 1 2 0 8 1 2 7 3 0 2 0



Cepillo aluminio
Gran formato 45 cm
Brosse aluminium
Grand Format 45 cm

Big Format 45 cm
Aluminium brush
Spazzola alluminio
Gran Formato 45 cm

REF. 40046N

DIS PACK 12



8 4 1 2 0 8 1 2 7 2 9 9 3



Limpiafondos triangular
rotativo con cepillos
Balai triangulaire
rotatif avec brosses

Triangular swivelling vac
head with brushes
Puliscifondo triangolare
rotante con spazzole

REF. 40016N

DIS PACK 4



8 4 1 2 0 8 1 2 7 3 0 4 4



Limpiafondos ovalado
rotativo con cepillos
Balai oval rotatif avec
brosses

Oval swivelling vac head
with brushes
Puliscifondo ovale rotante
con spazzole

REF. 40017N

DIS PACK 6



8 4 1 2 0 8 1 2 7 3 0 3 7



Limpiafondos manual rotativo 8
ruedas con cepillos laterales
Balai manuel rotatif 8 roues
avec brosses latérales

Swivelling vacuum head 8
wheels with lateral brushes
Puliscifondo manuale con 8
ruote e spazzole laterali

REF. 40018N

DIS PACK 12



8 4 1 2 0 8 1 2 7 3 0 5 1



Cepillo manual
multifunción
Brosse manuelle
multifonction

Multifunctional manual
brush
Spazzola manuale
multifunzione

REF. 40040N

DIS PACK 12



8 4 1 2 0 8 1 2 7 3 0 0 6

material de limpieza

cleaning material

GAMA SUPERLUXE SUPERLUXE RANGE
GAMME SUPERLUXE GAMMA SUPERLUXE

Cabezal Luxe aspirador
manual flexible con cepillos
Nettoyeur de fonds aspiration
flexible Luxe avec de brosses

Flexible Luxe suction pool
cleaner with brushes
Puliscifondo aspirazione
Luxe flessibile con spazzole

REF. LAMF10

CS PACK 6



Recogehojas de fondo
Luxe con malla de nylon
Époussette de fond Luxe avec
filet de nylon

Nylon net Luxe
leaf rake
Raccogliatore di fondo Luxe
con la maglia di nylon

REF. LRF10

CB PACK 12



Recogehojas de superficie
Luxe con malla de nylon
Époussette de surface Luxe avec
filet de nylon

Nylon net Luxe
leaf net
Raccogliatore di superficie
Luxe con la maglia di nylon

REF. LRS10

CB PACK 12



matériel de nettoyage materiale di pulizia

LIMPIAFONDOS MANUALES VACUUM HEADS BALAIS MANUELS PULISCIFONDO MANUALI



Limpiafondos triangular rotativo
Balai triangulaire rotatif

Triangular swivelling vac head
Puliscifondo triangolare rotante



REF. 40016

DIS 1/2N pack 4



Limpiafondos ovalado rotativo con cepillos laterales
Balai oval rotatif avec brosses latérales

Oval swivelling vac head with lateral brushes
Puliscifondo ovale rotante con spazzole laterali



REF. 40017

DIS 1/2N pack 6



Limpiafondos manual rotativo 8 ruedas con cepillos laterales
Balai manuel rotatif 8 roues avec brosses latérales

Swivelling vacuum head 8 wheels with lateral brushes
Puliscifondo manuale con 8 ruote e spazzole laterali



REF. 40018

DIS 3/4N pack 12



Limpiafondos de aluminio
Balai en aluminium

Aluminium vac head
Alluminio puliscifondo

REF. 40022

BX PACK 6

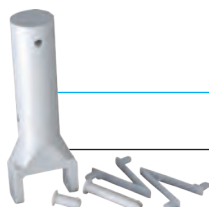

Empuñadura clip Ø28mm
Poignée clip Ø28mm

Clip handle Ø28mm
Impugnatura clip Ø28mm



REF. 40092

DIS 1/4N pack 20



material de limpieza

cleaning material

RECOGHOJAS LEAF NETS AND RAKES
ÉPUISETTES RACCOGLITORI

Recogehojas fondo aluminio
Épuiette de fond aluminium

Aluminium Leaf rake
Raccoglitore di fondo alluminio



REF. RHFAL

DIS 1/1N PACK 12



Recogehojas superficie aluminio
Épuiette de surface aluminium

Aluminium Leaf net
Raccoglitore di superficie alluminio

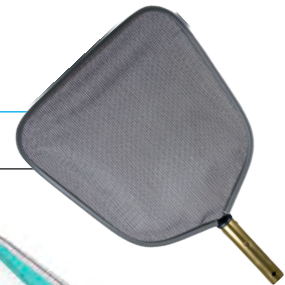

REF. RHSAL

DIS 1/1N PACK 12



Recogehojas de superficie
+ mango telescópico
Épuiette de surface
+ manche télescopique

Leaf net
+ telescopic handle
Raccoglitore di superficie
+ Manico telescopico



REF. 40031

CB PACK 12



Recogehojas de fondo
Gran Formato
Épuiette de fond
Grand Format

Big format
Leaf rake
Raccoglitore di fondo
Grand formato



REF. 40032

DIS 1/1 PACK 12



Recogehojas de superficie
Gran Formato
Épuiette de surface
Grand Format

Big format
Leaf net
Raccoglitore di superficie
Grand formato



REF. 40030

DIS 1/1 PACK 12



matériel de nettoyage materiale di pulizia

CEPILLOS BRUSHES BROSSES SPAZZOLE



Cepillo aluminio
Brosse aluminium

Aluminium brush
Spazzola alluminio

REF. 40046

DIS 3/4N pack 12



Cepillo aluminio para
eliminar algas
Brosse aluminium pour
éliminer les algues

Aluminium brush to
eliminate the algae
Spazzola alluminio
per eliminare le alghe

REF. CAA25

DIS 1/2N pack 32



Cepillo aspirante
Brosse aspirante

Vacuum brush
Spazzola con attacco per aspirare

REF. 40802

DIS 3/4N pack 10



Cepillo Gran Formato
Brosse Grand Format

Big Format brush
Spazzola Gran Formato

REF. 40041

DIS 3/4N pack 12



Cepillo línea de agua
Brosse ligne d'eau

Waterline brush
Spazzola per bordo acqua

REF. 40040

DIS 1/4N pack 12



Cepillo aspirador limpia-esquinas
Brosse aspirante d'angle

Corners-cleaner vacuum brush
Spazzola aspiratutto per angoli

REF. 40806

DIS 1/4N pack 18



TERMÓMETROS THERMOMETERS
THERMOMÈTRES TERMOMETRI

Termómetro pez payaso
Thermomètre de poisson clown

Clown fish thermometer
Termometro pesce pagliaccio



REF. TBF20

BXL PACK 12



Termómetro bola
Thermomètre boule

Ball thermometer
Termometro a sfera



REF. 40055

CB pack 15



Termómetro boya
Thermomètre bouée

Buoy thermometer
Termometro galleggiante



REF. 40054

DIS 1/2N pack 10



Termómetro tubular flotante
Thermomètre flottant tubulaire

Tubular floating thermometer
Termometro tubolare



REF. 40051

DIS 1/2N PACK 18



Termómetro "Big"
Doble lectura
"Big" Thermomètre
Double lecture

"Big" thermometer
Double reading
Termometro "Big"
Doppio lettura



REF. 40050

CS pack 12



matériel de nettoyage materiale di pulizia



Box mixto de termómetros pez versión standard y versión Led.

Box mixte de thermomètres poisson version standard et version Led.

Mixed box with standard and LED version fish thermometers.

Contenitore con misto di termometri a forma di pesce in versione standard e led.

REF. BT474

BXL pack 1



8 4 1 2 0 8 1 2 6 2 3 1 4

MANGOS TELESCÓPICOS TELESCOPIC HANDLES MANCHES TÉLESCOPIQUES MANICO TELESCOPICO



Mango telescópico de aluminio
Manche télescopique argenté
3,60 m (3 x 1,20m)

Telescopic aluminium handle
Manico telescopico argentato

REF. 40014

BX pack 12



8 4 2 7 3 7 0 4 0 0 1 4 8

Mango telescópico de aluminio
Manche télescopique argenté
4,80 m (2 x 2,40m)

Telescopic aluminium handle
Manico telescopico argentato

REF. 40011

BX pack 10



8 4 2 7 3 7 0 4 0 0 1 1 7

Mango telescópico de aluminio
Manche télescopique argenté
3,60 m (2 x 1,80m)

Telescopic aluminium handle
Manico telescopico argentato

REF. 40010

BX pack 10



8 4 2 7 3 7 0 4 0 0 1 0 0

Mango telescópico de aluminio
Manche télescopique argenté
2,40 m (2 x 1,20m)

Telescopic aluminium handle
Manico telescopico argentato

REF. 40013

BX pack 20



8 4 2 7 3 7 0 4 0 0 1 3 1

material de limpieza

cleaning material

DOSIFICADORES DISPENSERS DOSEURS DOSATORI

Combi Thermo-dosificador:
Dosificador Capacidad 1,5 Kg
(pastillas de 20 a
500 g) + Termómetro + Visor
de consumo de producto

Combi Thermo-doseur: Doseur
Capacité 1,5 Kg (pastilles de
20 à 500 g) + Thermomètre +
Témoin de consommation de
produit

Combi Thermo-dosifier:
Dosifier Capacity 1,5 kg (20
500 g tablets) +
Thermometer + Product
Consumption Viewer

Combi Thermo-Dosatore
Capacità 1,5 kg (Tavolette da
20 a 500 g)
+ Termometro + Controllo
livello del prodotto



REF. 40070

DIS 1/2N PACK 5



Combi Thermo-dosificador:
Dosificador pastillas de 20 g +
Termómetro + Visor de consumo
de producto

Combi Thermo-doseur:
Doseur pastilles de 20 g +
Thermomètre + Viseur de
consommation de produit

Combi Thermo-dosifier:
Dosifier 20g tablets +
Thermometer + Product
Consumption Viewer

Combi Thermo-Dosatore
Tavolette da 20 g +
Termometro + Controllo
livello del prodotto



REF. DCT20

DIS 1/2N PACK 36



Dosificador flotante.
Capacidad: 7 pastillas de 20 g
Doseur flottant.
Capacité 7 pastilles de 20 g

Floating dispenser.
Capacity: 7 tablets 20 g
Dosatore galleggiante.
Capacità 7 pastiglie da 20 g



REF. 40071

DIS 1/2N PACK 30



matériel de nettoyage materiale di pulizia

BOX
REF.786498

DIS PACK 1



REF	N°	Descripción. Describe. Désignation. Descrizione	CTD	EAN 13
778191	1	Dosificador. Dispenser. Diffuseur. Desatore	24	3 605217 781918
621201	2	Kit reparación liner. Liner repair kit. Kit réparation liner. Kit riparazione liner	36	3 605216 212017
777580	3	Recogehojas fondo. Leaf rake. Épuisette de fond. Raccogliatore di fondo	20	3 605217 775801
770311	4	Aspirador efecto venturi+bolsa. Jet vac with brush+bag. Aspirateur effet venturi+ beutel. Aspiratore effetto venturi	6	3 605217 703118
783810	5	Recogehojas superficie. Leaf net. Épuisette surface. Raccogliatore superficie	12	3 605217 838100
772804	6	Recogehojas superficie PVC. PVC Leaf net. Épuisette surface PVC. Raccogliatore superficie PVC	20	3 605217 728043
778201	7	Termómetro 16 cm. thermometer 16 cm. Thermomètre 16 cm. Termometro 16 cm.	33	3 605217 782014
770340	8	Cepillo manual. Hand brush. Brosse à main. Spazzola manuale	21	3 605217 703408
770326	9	Termómetros animal. Animals thermometer. Thermomètre animaux. Termometro animale	12	3 605217 703262
772876	10	Cepillo de pared 45 cm. 45 cm wall brush. Brosse de paroi 45 cm. Spazzola parete 45 cm	12	3 605217 728760
777917	11	Lavapiés. Footwash. Pédiluve. Lavapiedi	24	3 605217 779175
770342	12	Mango telescópico. telescopio handle. Manche télescopique. Manico telescopico	16	3 605217 703422

material de limpieza

cleaning material

NEW

CARDBOARD RANGE

Recogehojas de superficie
clásico

Époussette de surface
classique

Classic
Leaf net

Raccogliatore di superficie
classico

REF. 772804

CB PACK 12



3 605217 728043



Recogehojas de superficie
profesional

Époussette de surface
professionnelle

Professional
Leaf net

Raccogliatore di superficie
professionale

REF. 772868

CB PACK 12



3 605217 728685



Recogehojas de superficie +
mango aluminio

Époussette de surface + manche
aluminium

Leaf net + aluminium
telescopic handle

Raccogliatore di superficie
+ Manico telescopico alluminio

REF. 772869

CB PACK 12



3 605217 728692



Recogehojas fondo
clásico

Époussette de fond
classique

Classic
Leaf rake

Raccogliatore di fondo
classico

REF. 777580

CB PACK 12



3 605217 775801



Recogehojas fondo
profesional

Époussette de fond
professionnelle

Professional
Leaf rake

Raccogliatore di fondo
professionale

REF. 772872

CB PACK 12



3 605217 728722



matériel de nettoyage materiale di pulizia

NEW



Limpiafondos triangular rotativo con cepillos
Balai triangulaire rotatif avec brosses

Triangular swivelling vac head with brushes
Puliscifondo triangolare rotante con spazzole



REF. 777584

CS PACK 6



3 605217 775849



Limpiafondos ovalado rotativo con cepillos
Balai oval rotatif avec brosses

Oval swivelling vac head with brushes
Puliscifondo ovale rotante con spazzole

REF. 770306

CS PACK 6



3 605217 703064



Limpiafondos rotativo 8 ruedas con cepillos laterales
Balai rotatif 8 roues avec brosses latérales

Swivelling vacuum head 8 wheels with lateral brushes
Puliscifondo con 8 ruote e spazzole laterali



REF. 777573

CS PACK 6



3 605217 775733



Limpiafondos media luna clásico
Tête de Balai demi-lune classique

Half moon vacuum head classic
Puliscifondo mezza luna



REF. 777970

CS PACK 6



3 605217 779700



Cepillo aluminio Gran formato 45 cm
Brosse aluminium Grand Format 45 cm

Big Format 45 cm Aluminium brush
Spazzola alluminio Gran Formato 45 cm



REF. 772877

CB PACK 6



3 605217 728777



Cepillo de pared clásico de 45 cm
Brosse de paroi classique 45 cm

45 cm classic wall brush
Spazzola parete classico 45 cm

REF. 772876

CB PACK 12



3 605217 728760

material de limpieza

cleaning material



Kit mantenimiento
7 accesorios
Kit entretien
7 accessoires

Maintenance kit
7 accessories
Kit manutenzione
7 accessori

REF. 784880

CS PACK 6



3 605217 848802



Termómetro digital
flotante
Thermomètre digital
flottant

Floating digital
thermometer
Termometro digitale
galleggiante



REF. 778204

CS PACK 24



3 605217 782045



Termómetros animal
Thermomètre animaux

Animals thermometer
Termometro animale

REF. 770326

DIS PACK 12



3 605217 703262

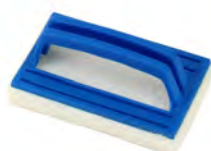

Esponja de la línea de
flotación
Eponges ligne
d'eau

Water line cleaner
sponges
Spugne per la linea di
galleggiamento

REF. 770334

CB PACK 6



3 605217 703347



Aspirador cepillo media luna
efecto venturi + bolsa
Aspirateur brosse demi-lune
effekt venturi +beutel

Jet vac with brush
and bag
Aspiratore con spazzola a
mezzaluna effetto venturi



REF. 772794

CS PACK 6



3 605217 727947



Bolsa de recambio aspirador
venturi modelo pequeño
Sac de recharge pour
aspirateur venturi petit modèle

Replacement bag
for jet vac
Sacca di ricambio per aspiratore
venturi modello piccolo

REF. 770344

PB PACK 24



3 605217 703446

matériel de nettoyage materiale di pulizia

BOX
REF. 90197

DIS PACK 1



REF	N°	Descripción. Describe. Désignation. Descrizione	CTD	EAN 13
90128	1	Cepillo linea de agua. Waterline brush. Brosse ligne d'eau. Spazzola per bordo acqua	36	8 427370 901287
90141	2	Dosificador de pastillas 20 gr. Tablets dispenser 20 gr. Doseur de pastilles 20gr. Dosatore pastiglie 20 gr	40	8 427370 901416
90181	3	Recambio para analizador (Oto / Phenol). Test kit (Oto/Phenol). Recharge pur kit d'analyse (Oto/Phenol) Ricarica Oto/Phenol	60	8 427370 901812
90140	4	Dosificador flotante de tabletas 200 gr. Tablets floatin dispenser 200 gr. Doseur de galets 200gr. Dosatore galleggiante pastiglie 200 gr	12	8 427370 901409
90120	5	Recogehojas de fondo. Leaf rake. Epuisette de fond. Raccoglitore di fondo	16	8 427370 901201
90115	6	Recogehojas de superficie. Leaf net. Epuisette de surface. Raccoglitore di superficie	24	8 427370 901157
90180	7	Analizador de cloro/bromo +pH (Oto / Phenol). Test kit chlorine/bromine + pH (Oto/Phenol). Kit d'analyse chlore/brome + pH (Oto/Phenol). Kit analisi cloro/bromo + pH (Oto/Phenol)	60	8 427370 901805
90125	8	Cepillo 20 cm. 20 cm brush. Brosse 20 cm. Spazzola 20 cm	16	8 427370 901256
90132	9	Termómetro animal. Animal thermometer. Thermomètre animal. Termometro animale	30	8 427370 901324
90130	10	Termómetro universal. Universal thermometer. Thermomètre universel. Termometro universale	60	8 427370 901300

material de limpieza

cleaning material



ECO RANGE

Recogehojas de superficie
Époussette de surface

Leaf net
Raccogliatore di superficie

REF. 90115

DIS 3/4N PACK 24



Recogehojas de superficie +
mango 122cm
Époussette de surface +
manche 122cm

Leaf net + handle
122cm
Raccogliatore di superficie
+ manico 122cm

REF. 90117

CB PACK 24



Recogehojas fondo
Époussette de fond

Leaf rake
Raccogliatore di fondo

REF. 90120

DIS 3/4N PACK 16



Recogehojas de superficie +
mango 5secciones 160 cm
Époussette de surface + perche
5 sections 160cm

Leaf net + 5 section
pole 160 cm
Raccogliatore di superficie +
manico sezionabile 160cm

REF. 90184

CB PACK 12

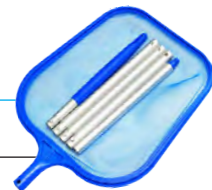

Mango telescópico
3 x 120 cm

Telescopic handle
3 x 120 cm

Manche télescopique
3 x 120 cm

Manico telescopico
3 x 120 cm

REF. 90100

CB PACK 10

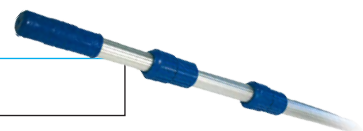

Limpiafondos 1/2 luna
Balai demi-lune

Vacuum head
Puliscifondo

REF. 90105

DIS 1/2N PACK 12



Aspirador cepillo media luna
Aspirateur brosse
demi-lune

Jet vac with brush
Aspiratore con spazzola a
mezzaluna

REF. 90110

DIS 3/4N PACK 8



Manguera limpiafondos 9m
Ø38mm
Tuyau pour nettoyeur 9m
Ø38mm

Vacuum hose 9m
Ø38mm
Tubo puliscifondo 9m
Ø38mm

REF. 90135

BX pack 1



matériel de nettoyage materiale di pulizia



Cepillo de 45 cm Brosse 45 cm	45 cm brush Spazzola 45 cm	REF. 90127	DIS 3/4N PACK 24	8 427370 901270
----------------------------------	-------------------------------	-------------------	-------------------------	-----------------



Cepillo de 20 cm Brosse 20 cm	20 cm brush Spazzola 20 cm	REF. 90125	DIS 1/4N PACK 16	8 427370 901256
----------------------------------	-------------------------------	-------------------	-------------------------	-----------------



Cepillo línea de agua Brosse ligne d'eau	Waterline brush Spazzola per bordo acqua	REF. 90128	DIS 1/4N PACK 36	8 427370 901287
---	---	-------------------	-------------------------	-----------------



Termómetro universal Thermomètre universel	Universal thermometer Termometro universale	REF. 90130	DIS 1/4N PACK 60	8 427370 901300
---	--	-------------------	-------------------------	-----------------



Termómetros animal Thermomètre animaux	Animals thermometer Termometro animale	REF. 90132	DIS 1/4N PACK 60	8 427370 901324
---	---	-------------------	-------------------------	-----------------



Dosificador flotante. tabletas 200 gr Doseur de galets 200 gr	Tablets floating dispenser 200 gr Dosatore galleggiante. pastiglie 200 gr	REF. 90140	DIS 3/4N PACK 12	8 427370 901409
--	--	-------------------	-------------------------	-----------------



Dosificador de pastillas 20 gr Doseur de pastilles 20 gr	Tablets dispenser 20 gr Dosatore pastiglie 20 gr	REF. 90141	DIS 3/4N PACK 40	8 427370 901416
---	---	-------------------	-------------------------	-----------------



Analizador de cloro/bromo + pH (Oto/Phenol) Trousse chlore/brome + pH (Oto/Phénol)	Test kit chlorine/bromine + pH (Oto/Phenol) Kit analisi cloro/bromo + pH (oto/Phenol)	REF. 90180	DIS 1/4N PACK 32	8 427370 901805
---	--	-------------------	-------------------------	-----------------



Recambio Oto/Phenol Recharge Oto/Phénol	Test kit Oto/Phenol Ricambio Oto/Phenol	REF. 90181	DIS 1/4N PACK 60	8 427370 901812
--	--	-------------------	-------------------------	-----------------

material de limpieza

cleaning material

PRODUCTOS COMPLEMENTARIOS COMPLEMENTARY PRODUCTS
PRODUITS COMPLÉMENTAIRES PRODOTTI COMPLEMENTARI

Guante con esponja
para limpiar la línea de
flotación
Gant avec éponge pour le
nettoyage de la ligne de
flottaison sur le liner

Glove with cleaning
sponge for water line
Guanto in spugna
per pulire la linea di
galleggiamento

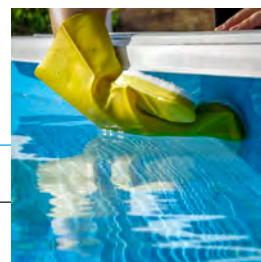

REF. GFL5

CB pack 24



8 412081 264400

Esponjas mágicas para
la línea de flotación
4 unidades

Eponges magiques
nettoyant ligne d'eau
4 unités

Water line cleaner
magic sponges
4 units

Spugne magiche per la
linea di galleggiamento
4 unità

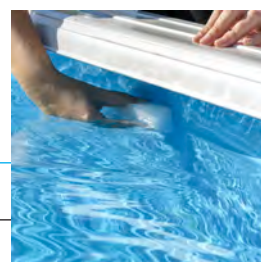

REF. PGL4

DIS pack 12



8 412081 264431

protection hiver

protezione per l'inverno

PROTECCIÓN INVIERNO WINTER PROTECTION
PROTECTION HIVER PROTEZIONE PER L'INVERNO



Flotador de hibernaje
Flotteur d'hivernage

Winterising float
Galleggiante inverno

REF. 40580

BX PACK 10



Gizmo - protección del skimmer
Gizmo - protection du skimmer

Gizmo - skimmer protection
Gizmo - protezione per skimmer

REF. 40581

BX PACK 12



Tapón de invernaje 1,5"
Bouchon d'hivernage 1,5"

Winterising plug 1,5"
Tappo inverno 1.5"

REF. 40582

BX PACK 6



Tapón de invernaje 2"
Bouchon d'hivernage 2"

Winterising plug 2"
Tappo inverno 2"

REF. 40583

BX PACK 6



material de limpieza

cleaning material

MANGUERAS VACUUM HOSES

TUYAUX FLOTTANTS TUBI GALLEGGIANTI

Manguera limpiafondos 15m
con 2 terminales Ø38mm
Tuyau pour nettoyeur de fond 15m
avec 2 embouts soudés Ø38mm

Vacuum hose 15m
with 2 cuffs Ø38mm
Tubo puliscifondo 15m
con 2 terminali da Ø38mm

REF. 40004

BX pack 1



Manguera limpiafondos 12m
con 2 terminales Ø38mm
Tuyau pour nettoyeur de fond 12m
avec 2 embouts soudés Ø38mm

Vacuum hose 12m
with 2 cuffs Ø38mm
Tubo puliscifondo 12m
con 2 terminali da Ø38mm

REF. 40003

BX pack 1



Manguera limpiafondos 10m
con 2 terminales Ø38mm
Tuyau pour nettoyeur de fond 10m
avec 2 embouts soudés Ø38mm

Vacuum hose 10m
with 2 cuffs Ø38mm
Tubo puliscifondo 10m
con 2 terminali da Ø38mm

REF. 40002

BX pack 1



Manguera limpiafondos 8m
con 2 terminales Ø38mm
Tuyau pour nettoyeur de fond 8m
avec 2 embouts soudés Ø38mm

Vacuum hose 8m
with 2 cuffs Ø38mm
Tubo puliscifondo 8m
con 2 terminali da Ø38mm

REF. 40001

BX pack 1



Manguera limpiafondos 6m
con 2 terminales Ø38mm
Tuyau pour nettoyeur de fond 6m
avec 2 embouts soudés Ø38mm

Vacuum hose 6m
with 2 cuffs Ø38mm
Tubo puliscifondo 6m
con 2 terminali da Ø38mm

REF. AR210

BX pack 1



matériel de nettoyage

materiale di pulizia



Manguera limpiafondos 4m
con 2 terminales Ø38mm
Tuyau pour nettoyeur de fond 4m
avec 2 embouts soudés Ø38mm

Vacuum hose 4m
with 2 cuffs Ø38mm
Tubo puliscifondo 4m
con 2 terminali da Ø38mm

REF. AR212

BXL pack 1



8 412081 240824



Manguera limpiafondos 12m
con 2 terminales Ø32mm
Tuyau pour nettoyeur de fond 12m
avec 2 embouts soudés Ø32mm

Vacuum hose 12m
with 2 cuffs Ø32mm
Tubo puliscifondo 12m
con 2 terminali da Ø32mm

REF. 770323

BXL pack 1



3 605217 703231



Manguera limpiafondos 7m
con 2 terminales Ø32mm
Tuyau pour nettoyeur de fond 7m
avec 2 embouts soudés Ø32mm

Vacuum hose 7m
with 2 cuffs Ø32mm
Tubo puliscifondo 7m
con 2 terminali da Ø32mm

REF. 770322

BXL pack 1



3 605217 703224



Enrollador de mangueras
flotantes hasta 15m.
(Manguera no incluida)

Vacuum hoses roller
maximum 15m.
(Vacuum hoses not included)

Enrouleur de tuyaux
flottants. Jusqu'à 15m.
(Tuyau non inclus)

Avvolgitore per tubo
galleggiante fino a 15 m.
(Tubo non incluso)

REF. 90165

CBX PACK 1



8 427370 901652



Terminal manguera flotante - Ø38mm
Embout tuyau flottant - Ø38mm

Hose cuff - Ø38mm
Raccordo per tubo Ø38 mm

REF. 40012

BX PACK 20



8 427370 400124



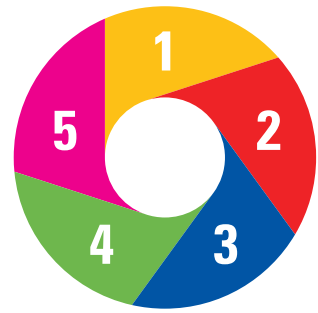

producto químico chemicals
produits d'entretien prodotti chimici



**MADE
IN
EU**

PASOS PARA CUIDAR DE SU PISCINA STEPS TO TAKE CARE OF YOUR SWIMMING POOL
ETAPES À SUIVRE POUR PRENDRE SOIN DE VOTRE PISCINE INDICAZIONI PER IL TRATTAMENTO DELLA PISCINA



Regular el pH
 pH regulation
 Réguler le pH
 Correttori di pH

Higienizar el agua
 Water sanitizing
 Higiéniser l'eau
 Igienizzazione dell'acqua

1

2

3a

3b

3c

¿Cómo?
How?
 ¿Comment?
 ¿Come?

Minorador de pH
 pH reduce
 Baisse le pH
 Riduttore di pH

Incrementador de PH
 pH increase
 Augmente le pH
 Incrementatore pH

Cloro choque
 Shock chlorine
 Chlore choc
 Cloro shock

Cloro lento
 Slow
 chloration
 Chlore lent
 Cloro lento

Bromo
 Bromine
 Brome
 Bromine

Oxígeno activo
 Active oxygen
 Oxygène actif
 Ossigeno attivo

¿Para qué?
Why?
 ¿Pourquoi?
 ¿Perché?

Obtener un pH entre 7,2 y 7,6
 To have a pH value between 7,2 and 7,6
 Obtenir un pH entre 7,2 et 7,6
 Stabilizzare pH tra 7.2 e 7.6

Higienizar rápidamente y destruir los organismos, hongos y bacterias
 To sanitize quickly and to eliminate all the organisms and bacteria
 Higiéniser rapidement et détruire les organismes, champignons et bactéries
 igienizzare rapidamente e distruggere tutti gli organismi, funghi e batteri

Desinfectar permanentemente
 To have a permanent disinfection
 Désinfecter en permanence
 Disinfezione permanente

¿Cuándo?
When?
 ¿Quand?
 ¿Quando?

A diario
 Daily
 Chaque jour
 Trattamento quotidiano

Al inicio de temporada / Después de condiciones climáticas extremas / Uso intensivo de la piscina
 At the beginning of the swim season / After bad weather conditions / High use level
 Début de saison / Après des conditions climatiques extrêmes / Usage intensif de la piscine
 Inizio stagione / Dopo che si sono verificate cambiamenti climatici molto forti / Uso intensivo della piscina

A diario
 Daily
 Chaque jour
 Trattamento quotidiano

Resultado
Result
 Résultat
 Risultato

pH ideal para la piel y los ojos. Instalaciones en perfecto estado
 Ideal pH for skin and eyes. Good conditions equipment
 pH idéal pour la peau et les yeux. Installations en parfait état
 pH stabile non genera fastidi ad occhi e alla pelle

Agua limpia y libre de posibles contagios
 Clean water without contagious risk
 Eau propre et libre de possibles contagions
 Acqua pulita e libera da ogni impurità

Agua limpia y libre de posibles contagios
 Clean water without contagious risk
 Eau propre et libre de possibles contagions
 Acqua pulita e libera da ogni impurità

produits d'entretien prodotti chimici



Tratamiento antialgas
Anti-algae treatment
Traitement anti-algues
Trattamento antialghe

Floculación
Flocculation
Floculation
Floculante

Complet 4
Actions

Total 5 Actions

Total 10 Actions

4

5

Antialgas concentrado
Concentrated algaecide
Anti-algues concentré
Antialghe concentrato

Antialgas Extra
Extra anti-algae
Anti-algues Extra
Antialghe extra

Floculante
Flocculant
Floculant
Floculante

Fórmula innovadora que permite en una sola aplicación, eliminar bacterias, virus y microorganismos en general

Thanks to its new formula, you can eliminate bacteria, virus and microorganisms

Formule innovatrice, il permet avec une seule application, d'éliminer bactéries, virus et microorganismes en général

Formula innovativa che permette in una sola applicazione eliminare i batteri, virus e microorganismi in generale

Prevenir la aparición de algas
To avoid algae apparition
Prevenir l'apparition des algues
Prevenire la comparsa delle alghe

Eliminar las algas existentes
To eliminate the algae
Éliminer les algues existantes
Eliminare la presenza di alghe

Eliminar las partículas en suspensión
To eliminate particles in suspension
Éliminer les particules en suspension
Elimina le impurità

4 funciones:
- Cloro
- Antialgas
- Estabilizante
- Floculante

4 functions:
- Chlorine
- Antialgae
- Stabiliser
- Flocculant

4 fonctions:
- Chlore
- Anti-algues
- Stabilisant
- Floculant

4 funzioni:
- Cloro
- Antialghe
- Stabilizzante
- Floculante

5 funciones:
- Cloro
- Antialgas
- Estabilizante
- Floculante
Anticalcáreo

5 functions:
- Chlorine
- Antialgae
- Stabiliser
- Flocculant
- Antilime

5 fonctions:
- Chlore
- Anti-algues
- Stabilisant
- Floculant
- Anticalcaire

5 funzioni:
- Cloro
- Antialghe
- Stabilizzante
- Floculante
- Anticalcare

10 funciones:
- Bactericida - Regulador de pH
- Floculante - Estabilizante de cloro
- Coagulante - Anticalcáreo
- Algicida - Viricida
- Algostático - Fungicida

10 functions:
- Germicide - pH regulator
- Flocculent - Chlorine stabilizer
- Coagulant - Anti-Limescale Agent
- Algicide - Virucide
- Algistatic - Fungicide

10 fonctions:
- Bactéricide - Régulateur de pH
- Floculant - Stabilisant de chlore
- Coagulant - Anticalcaire
- Algicide - Virucide
- Algistatique - Fongicide

10 funzioni:
- Battericida - Regolatore de pH
- Floculante - Stabilizzante del cloro
- Coagulante - Anticalcare
- Alghicida - Virucida
- Alghistico - Funghicida

Según convenga
Depending on water quality
Selon convenance
Quando necessario

Semanalmente
Weekly
Chaque semaine
Settimanalmente

Agua sin algas
Water without algae

Agua cristalina
Crystalline water

Cálculo de volumen de agua

Para un correcto suministro del producto químico, es importante calcular el volumen de agua de la piscina.

Calculate the pool water volume

It is important to calculate the pool water volume to do a correct chemical treatment.

Calcul de volume d'eau

Pour un bon dosage du produit chimique, il est nécessaire de calculer le volume d'eau de la piscine.

Calcolo del volume d'acqua

Per un corretto dosaggio del prodotto chimico è importante calcolare il volume d'acqua di una piscina.

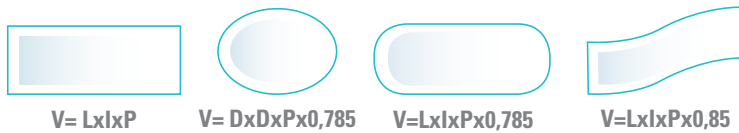

V	Volumen en m ³	Volume in m ³	Volume en m ³	Volume in m ³
L	Longitud en m	Length in m	Longueur en m	Lunghezza in m
I	Anchura en m	Width in m	Largeur en m	Larghezza in m
D	Diámetro en m	Diameter in m	Diamètre en m	Diametro in m
P	Profundidad en m	Depth in m	Profondeur en m	Profondità media in m

Ejemplo Example Exemple Esempio

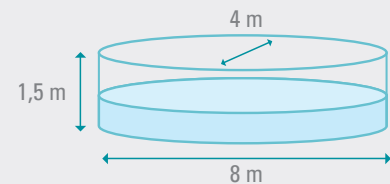

$$1,5 \text{ m} \times 8 \times 4 \times 0,785 = 37,68 \text{ m}^3$$

LEYENDA LEGEND LÉGENDE LEGENDA

	500 g				1 L
	1 Kg		10 Kg		
	1 Kg / 1,5 Kg		1 L		1 kg
	3 kg		3 L		1 L / 0,5 L
	5 Kg		5 L		1/2 BOX PALET
	5 Kg		10 L		

REGULADORES DE PH PH REGULATORS
RÉGULATEURS DE PH CORRETTORI DI PH



El pH indica la acidez o la basicidad del agua. En una piscina debe mantenerse ajustado entre los valores 7.2 y 7.6, ya que además de conservar las instalaciones en óptimas condiciones, es el ideal para la piel y los ojos de los bañistas.

pH shows if water is acid or basic. Pool water pH must be between 7.2 and 7.6, because it helps to conserve the equipment in good conditions and it is ideal for swimmer eyes and skin.

Le pH indique l'acidité ou la basicité de l'eau. L'eau de la piscine doit se maintenir entre les taux 7.2 et 7.6, car il aide à mieux conserver les installations et est l' idéal pour la peau et les yeux des baigneurs.

Il pH indica la acidità e la basicità dell' acqua. In una piscina il valore di riferimento deve essere sempre tra 7.2 e 7.6, dal momento che, oltre a favorire il trattamento chimico che viene effettuato, è il valore ideale affinché la pelle e gli occhi dei bagnanti non si irritino.



INCREMENTADOR DE pH pH INCREASE
AUGMENTE LE pH INCREMENTATORE pH

pH PLUS

GRANULADO GRANULES GRANULÉS GRANULATO



Ref. **76018** 1 Kg pack 20  8 4 2 7 3 7 0 7 6 0 1 8 1



Ref. **76001** 5 Kg pack 4  8 4 2 7 3 7 0 7 6 0 0 1 3

Incrementador de pH: para aumentar y estabilizar el pH
 pH increase: to increase and stabilize pH
 Augmente le pH: pour augmenter et stabiliser le pH
 Per aumentare e stabilizzare il pH

MINORADOR DE pH pH REDUCE
BAISSE LE pH RIDUTTORE pH

pH MINUS

GRANULADO GRANULES GRANULÉS GRANULATO



Ref. **76019** 1,5 Kg pack 20  8 4 2 7 3 7 0 7 6 0 1 9 8



Ref. **76002** 5 Kg pack 4  8 4 2 7 3 7 0 7 6 0 0 2 0

Minorador de pH: para bajar y estabilizar el pH
 pH reduce: to lower and stabilize pH
 Baisse le pH: pour baisser et stabiliser le pH
 Per abbassare e stabilizzare il pH

7.2

7.6



use pH+

use pH-

Higienizantes Sanitizing Hygiénisation Igienizzanti

Para poder tener un agua transparente y en definitiva libre de posibles contagios, es imprescindible que ésta sea higienizada regularmente. Los productos higienizantes pueden ser de diversos tipos, siendo los más comunes los productos clorados, aunque también existen otras soluciones alternativas, igualmente con un elevado poder higienizante, como el bromo o el oxígeno activo.

In order to have clear water without contagious danger, it is necessary to treat it regularly. There exist several kind of sanitizing, whose most common is chlorine. Other solutions like bromine or oxygen have also a high sanitizing action.

Pour avoir une eau transparente et libre de bactéries, il est indispensable que celle-ci soit traitée régulièrement. Il existe plusieurs sortes de hygiénisants, le chlore étant le plus connu. Également, il y a d'autres solutions alternatives avec un haut pouvoir hygiénisant, comme le brome ou l'oxygène actif.

Per avere un'acqua pulita e libera da ogni possibile contagio è indispensabile che quest'ultima sia igienizzata regolarmente. Gli igienizzanti più comuni sono a base di cloro, ma possono essere di diverso tipo dal momento che, esistono altre soluzioni alternative, come per esempio l'ossigeno attivo e il bromo.



CLORO LENTO TRICHLORINE CHLORE LENT CLORO LENTO

Para conseguir una higienización preventiva y continua del agua, es necesario mantener una tasa de cloración libre. Por ello, conviene efectuar una cloración permanente o "cloración lenta".

To have a preventive and continue sanitizing, it is necessary to keep a free chloration value. For this reason, people must do a permanent chloration or a "slow chloration".

Pour avoir une hygiénisation préventive et continue, il est nécessaire de maintenir un taux de chloration libre. Pour cette raison, il faut effectuer une chloration permanente ou «chloration lente».

Per ottenere una igienizzazione preventiva e continua dell'acqua, è necessario mantenere un valore di cloro "libero". Per questo è bene effettuare una clorazione continua o una "clorazione lenta".

CLORLENT

TABLETAS 250g 250g TABLETS GALETS 250g PASTIGLIE 250g



Ref. 76022 1 Kg pack 20 8 4 2 7 3 7 0 7 6 0 2 2 8



Ref. 76005 5 Kg pack 4 8 4 2 7 3 7 0 7 6 0 0 5 1

GRANULADO GRANULES GRANULÉS GRANULATO



Ref. 76023 1 Kg pack 20 8 4 2 7 3 7 0 7 6 0 2 3 5



CLORO CHOQUE SHOCK CHLORINE CHLORE CHOC CLORO SHOCK

El Cloro Choque permite destruir rápida y eficazmente todos los organismos, hongos y bacterias. Conviene realizar una cloración de choque: Al inicio de la temporada de baño / Después de condiciones climáticas extremas / En caso de uso intensivo de la piscina.

It eliminates quickly all the organisms and bacteria. It is necessary to do a Shock chloration: At the beginning of the swim season / After bad weather conditions / High use level.

Le Chlore Choc permet de détruire rapidement tous les organismes, champignons et bactéries. Il convient d'effectuer une chloration choc: Au début de la saison de baignade / Après des conditions climatiques extrêmes / En cas d'usage intensif de la piscine.

Permette di eliminare rapidamente ed efficacemente tutti gli organismi, funghi e batteri. È utile usare questo tipo di prodotto: All'inizio della stagione / Dopo condizioni climatiche estreme / In caso di un uso intensivo della piscina.

CLORCHOC

PASTILLAS 20g 20g TABLETS PASTILLES 20g PASTIGLIE 20g



Ref. 76020 1 Kg pack 20 8 4 2 7 3 7 0 7 6 0 2 0 4



Ref. 76070 3 Kg pack 4 8 4 2 7 3 7 0 7 6 0 7 0 9

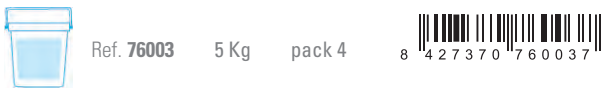

Ref. 76003 5 Kg pack 4 8 4 2 7 3 7 0 7 6 0 0 3 7

Con un 50% de cloro activo mínimo (tricloro). Disolución instantánea.

Minimum 50% active chlorine (trichlorine). Instant dissolution.

50% chlore actif minimum (trichlore). Dissolution instantanée.

Con un minimo del 50% di cloro attivo (tricloro). Dissoluzione istantanea.

GRANULADO GRANULES GRANULÉS GRANULATO



Ref. 76021 1 Kg pack 20 8 4 2 7 3 7 0 7 6 0 2 1 1



Ref. 76062 1 Kg pack 200 8 4 2 7 3 7 0 7 6 0 6 2 4



Ref. 76069 3 Kg pack 4 8 4 2 7 3 7 0 7 6 0 6 9 3



Ref. 76004 5 Kg pack 4 8 4 2 7 3 7 0 7 6 0 0 4 4

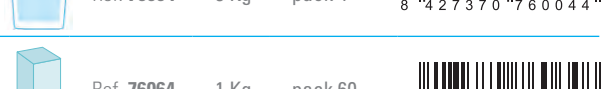

Ref. 76064 1 Kg pack 60 8 4 2 7 3 7 0 7 6 0 6 4 8

Con un 55% de cloro activo mínimo. Disolución rápida.

Minimum 55% active chlorine. Quick dissolution.

55% chlore actif minimum. Dissolution rapide.

Con un 55% di cloro minimo attivo. Dissoluzione rapida.

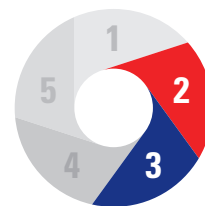

BROMO BROMINE BROME BROMO

Diferencias respecto al cloro: menos olor, no daña la piel ni el cabello. Más eficacia en las aguas calientes y/o calcáreas.

Differences compared to chlorine: less smell, does not dry out skin and hair. More efficient in hot and/or calcareous water.

Différences par rapport au chlore: moins d'odeur, ne dessèche pas la peau ni les cheveux. Plus efficace dans les eaux chaudes et/ou calcaires.

Differenze rispetto al cloro: meno odore, non danneggia la pelle né i capelli. Più efficace con l'acqua molto calda e/o calcarea.

BROM LENT

PASTILLAS 20g 20g TABLETS PASTILLES 20g PASTIGLIE 20g

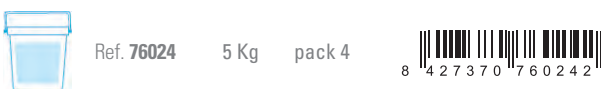

BROM CHOC

GRANULADO GRANULES GRANULÉS GRANULATO

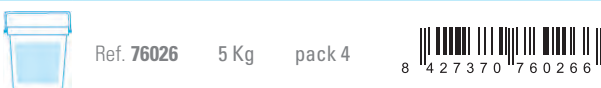

BROM MULTI-ACTIONS

PASTILLAS 20g 20g TABLETS PASTILLES 20g PASTIGLIE 20g



Bromo multi-Acciones
Bromine multi-Actions
Brome multi-Actions
Bromo multi funzioni



OXÍGENO ACTIVO ACTIVE OXYGEN OXYGÈNE ACTIF OSSIGENO ATTIVO

Ofrece muchas ventajas, ya que proporciona una desinfección muy eficaz y a diferencia del cloro, no provoca irritaciones oculares ni desprende olores desagradables. Producto que necesita de un dosificador.

This product offers a lot of advantages. It disinfects pool water and contrary to chlorine, it does not cause eye irritation neither and bad smells. This product needs a dispenser.

Ce produit offre beaucoup d'avantages par rapport au chlore, car il ne provoque aucune irritation oculaire, ôte les mauvaises odeurs et en même temps fait une désinfection très efficace. Il a besoin d'un doseur.

Offre molti vantaggi, dal momento che sviluppa una igienizzazione molto efficace e, a differenza del cloro, non irrita gli occhi e non ha un odore sgradevole. È un prodotto che necessita del dosatore.

ACTI OXY

LÍQUIDO LIQUID LIQUIDE LIQUIDO



OXY LENT

PASTILLAS 20g 20g TABLETS PASTILLES 20g PASTIGLIE 20g



Multifunciones Multiactions
Multi-actions Multi funzioni

Se trata de un producto revolucionario, ya que gracias a su fórmula innovadora permite en una sola aplicación, eliminar las bacterias, virus y microorganismos en general, evitar el desarrollo de algas, al mismo tiempo que mantiene transparente y cristalina el agua.
Revolution product: Thanks to its new formula, allows in a single application eliminate bacteria, virus and micro organisms, avoid algae and have clear and crystalline water.

Il s'agit d'un produit révolutionnaire. Grâce à sa formule innovatrice, il permet avec une seule application, d'éliminer les bactéries, virus et micro organismes en général, d'éviter l'apparition d'algues, ainsi que de conserver l'eau transparente et cristalline.

Si tratta di un prodotto rivoluzionario proprio perché, grazie alla sua formula innovatrice, permette, in una sola applicazione, di eliminare i batteri, virus e tutti i microorganismi evitando il proliferare di alghe, mantenendo allo stesso tempo l'acqua trasparente e cristallina.

COMPLET 4 ACCIONES COMPLET 4 ACTIONS
COMPLET 4 ACTIONS COMPLET 4 AZIONI

Cloro + Antialgas + Estabilizante + Floculante
Chlorine + Antialgae + Stabiliser + Flocculant
Chlore + Anti-algues + Stabilisant + Flocculant
Cloro + Antialghe + Stabilizzante + Flocculante

COMPLET 4 ACTIONS

1 BLOQUE 500g 500g 1 BLOCK 1 BLOC 500g PASTIGLIA 500g 1

 Ref. **76035** 0,5Kg pack 48  8 427370 760358

TABLETAS 250g 250g TABLETS GALETS 250g PASTIGLIE 250g



 Ref. **76007** 1 Kg pack 20  8 427370 760075

 Ref. **76063** 1 Kg pack 200  8 427370 760631

 Ref. **76067** 3 Kg pack 4  8 427370 760679

 Ref. **76006** 5 Kg pack 4  8 427370 760068

 Ref. **76055** 5 Kg pack 60  8 427370 760556



 Ref. **76031** 10 Kg pack 2  8 427370 760310

PASTILLAS 20g 20g TABLETS PASTILLES 20g PASTIGLIE 20g

 Ref. **76032** 1 Kg pack 20  8 427370 760327

 Ref. **76033** 5 Kg pack 4  8 427370 760334

GRANULADO GRANULES GRANULÉS GRANULATO



 Ref. **76034** 5 Kg pack 4  8 427370 760341



COMPLET 4 ACTIONS- SPECIAL LINER

TABLETAS 250g 250g TABLETS GALETS 250g PASTIGLIE 250g

 Ref. **76039** 1 Kg pack 20  8 427370 760396

 Ref. **76012** 5 Kg pack 4  8 427370 760129

Sin sulfato de cobre
Without copper sulphate.
Sans sulfato de cuivre
Senza solfato di rame



**MULTIFUNCIÓN MONODOSES
MONODOSE MULTI-ACTIONS
MULTI-ACTIONS MONODOSE
MULTI FUNZIONI MONODOSI**

Cloro + Antialgas + Estabilizante + Floculante
Chlorine + Antialgae + Stabiliser + Flocculant
Chlore + Anti-algues + Stabilisant + Floculant
Cloro + Antialghe + Stabilizzante + Floculante

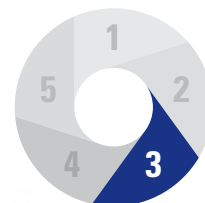

**TOTAL 5 ACCIONES TOTAL 5 ACTIONS
TOTAL 5 ACTIONS TOTAL 5 AZIONI**

Cloro + Antialgas + Estabilizante + Floculante + Antical
Chlorine + Antialgae + Stabiliser + Flocculant + Anti lime
Chlore + Anti-algues + Stabilisant + Floculant + Anti-calcaire
Cloro + Antialghe + Stabilizzante + Floculante + Anticalcare

MULTIACTIONS

TABLETAS 250g 250g TABLETS GALETS 250g PASTIGLIE 250g



Ref. 76058 5 Kg pack 16



16 dosis de 250g. Fácil de usar, dosis exacta. Para piscinas hasta 60m³
250gr 16 dose. Easy to use, accurate dose. Pools up to 60m³.
16 doses de 250g. Facile à utiliser, dose précise. Pour piscines de jusqu'à 60m³.
16 dosi da 250 grammi. Semplice da utilizzare: eroga sempre la dose corretta. Per piscine fino a 60 m³

TOTAL 5 ACTIONS

TABLETAS 250g 250g TABLETS GALETS 250g PASTIGLIE 250g



Ref. 76068 3 Kg pack 4



Ref. 76036 5 Kg pack 4



Ref. 76037 10 Kg pack 2



**TOTAL 10 ACCIONES TOTAL 10 ACTIONS
TOTAL 10 ACTIONS TOTAL 10 AZIONI**

Desinfectante + Bactericida + Floculante + Coagulante +
Algicida + Algistático + Regulador de pH + Estabilizante
de cloro + Anticalcáreo + Virucida + Fungicida
Disinfectant+ Germicide + Flocculent + Coagulant +
Algicide + Algistatic + pH regulator + Chlorine stabilizer +
Anti-Limescale Agent + Virucide+ Fungicide
Désinfectant + Bactéricide + Flocculant + Coagulant +
Algicide + Algistatique + Régulateur de pH + Stabilisant
de chlore + Anticalcaire + Virucide + Fongicide
Disinfettante + Battericida + Floculante + Coagulante +
Alghicida + Alghistatico + Regolatore del pH + Stabilizzante
del cloro + Anticalcare + Virucida + Funghicida

TOTAL 10 ACTIONS

TABLETAS 250g 250g TABLETS GALETS 250g PASTIGLIE 250g



Ref. 76065 1 Kg pack 20



Ref. 76038 5 Kg pack 4



**MULTIFUNCIONES BICAPA
TWO-LAYER MULTI-ACTIONS
MULTI-ACTIONS BICOUCHE
MULTI FUNZIONI DOPPIO STRATO**

Cloro multifunción + choque
Multiactions + shock chlorine
Chlore multi-actions + choc
Cloro multi funzioni + shock



MULTIACTIONS + CHOC

TABLETAS 250g 250g TABLETS GALETS 250g PASTIGLIE 250g



Ref. 76040 1 Kg pack 6



Tratamiento antialgas **Anti-algae treatment** Traitement anti-algues **Trattamento antialghe**



ANTIALGAS EXTRA EXTRA ANTI ALGAE ANTI-ALGUES EXTRA ANTIALGHE EXTRA

ANTIALG XTRA

LÍQUIDO LIQUID LIQUIDE LIQUIDO

 Ref. **76041** 1 L pack 12 

 Ref. **76072** 3 L pack 6 

 Ref. **76042** 5 L pack 4 

3 acciones. Extra: para eliminar todas las algas.
 3 actions. Extra: to eliminate the algae.
 3 actions. Extra: pour éliminer la totalité des algues.
 3 azioni. Extra. Per eliminare tutti i tipi di alghe.

ANTIALG

LÍQUIDO LIQUID LIQUIDE LIQUIDO

 Ref. **76009** 1 L pack 12 

 Ref. **76071** 3 L pack 6 

 Ref. **76008** 5 L pack 4 

 Ref. **76056** 5 L pack 48 

Para prevenir la aparición de algas.
 To prevent the appearance of algae
 Pour prévenir l'apparition d'algues.
 Per prevenire la comparsa delle alghe.



Las algas son organismos vegetales unicelulares que pueden desarrollarse y multiplicarse rápidamente en el agua, sobre todo cuando su temperatura es templada.

Algae are vegetal unicellular organisms that can quickly develop and multiply themselves in the water, specially when the temperature of the water is warm.

Les algues sont des organismes végétaux unicellulaires qui peuvent apparaître et se multiplier très rapidement dans l'eau, surtout quand la température de l'eau est tempérée.

Le alghe sono organismi vegetali unicellulari che possono svilupparsi e moltiplicarsi soprattutto quando la temperatura dell'acqua è abbastanza calda.



ANTIALGAS CONCENTRADO CONCENTRATED ANTI ALGAE ANTI-ALGUES CONCENTRÉ ANTIALGHE CONCENTRATO

ANTIALG COMPACT XTRA

LÍQUIDO LIQUID LIQUIDE LIQUIDO

 Ref. **76013** 1 L pack 12 

 Ref. **76014** 0,5 L pack 24 

ANTIALG COMPACT

LÍQUIDO LIQUID LIQUIDE LIQUIDO

 Ref. **76015** 1 L pack 12 

 Ref. **76016** 0,5 L pack 24 

Floculante Flocculant
Floculant Flocculante

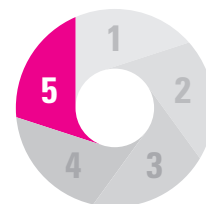

La floculación permite obtener un agua cristalina. Existen dos tipos de floculación: la que se realiza dentro del filtro y la floculación dentro del vaso. La primera permite aumentar la fineza de filtración y eliminar de esta manera las partículas más finas. Ésta se efectúa gracias a los cartuchos floculantes (incompatibles con filtros de cartucho) colocados en el cesto del skimmer. La segunda permite agrupar entre ellas las impurezas que no pueden ser filtradas individualmente y que son el origen de un agua turbia. Esta operación se efectúa con el floculante líquido.

Flocculation allows to obtain a crystalline water. There are two kind of flocculation: inside the filter and in the pool. With the first one we increase the fineness of filtration in order to eliminate smaller particles. For this process we introduce flocculants cartridges (incompatible with cartridge filters) in the skimmer basket. The second one helps us to group all the impurities that are the beginning of brown water thanks to liquid flocculant.

La floculation permet d'obtenir une eau cristalline. Il y a deux types de floculation: celle qui se fait dans le filtre et la floculation dans le bassin. La première permet d'augmenter la finesse de filtration et d'éliminer de cette façon les particules plus fines. S'effectue grâce aux cartouches floculantes (incompatibles avec les filtres à cartouche) dans le panier du skimmer. La deuxième permet de regrouper entre elles les impuretés qui ne peuvent pas être filtrées et qui sont l'origine des eaux troubles. Cette opération se fait avec le floculant liquide.

La flocculazione permette di ottenere un'acqua cristallina. Esistono due tipi di flocculazione: quella che si realizza all'interno del filtro e quella diluendo il prodotto in un contenitore. La prima permette di migliorare la filtrazione ed eliminare le particelle più fini e si effettua grazie alle cartucce floculanti (incompatibili con i filtri a cartuccia) poste dentro il cesto dello skimmer. La seconda permette di raggruppare tra loro le impurità che non possono essere filtrate individualmente e che sono la causa dell'acqua torbida. Questo procedimento si effettua con il floculante liquido.



CARTUCHOS 125g 125g CARTRIDGES CARTOUCHES 125g CARTUCCIA 125g

Ref. **76044** 1 Kg pack 14

Para mejorar la calidad de filtración (filtros de arena únicamente).
Producto de mantenimiento.
To increase filtration quality (sand filters only).
Product Maintenance.
Pour améliorer la qualité de filtration (filtres à sable uniquement).
Produit de maintenance.
Per migliorare la qualità della filtrazione (solo per filtri a sabbia).
Prodotto di mantenimento.

FLOCULANTE LÍQUIDO LIQUID FLOCCULANT
FLOCULANT LIQUIDE FLOCCULANTE LIQUIDO

FLOCULANT

LÍQUIDO LIQUID LIQUIDE LIQUIDO

Ref. **76011** 1 L pack 12

Ref. **76073** 3 L pack 6

Ref. **76010** 5 L pack 4

Para clarificar el agua y eliminar las materias en suspensión.
Recupera el agua turbia.
To clarify water and eliminate substances in suspension.
Retrieve the cloudy water.
Pour clarifier l'eau et éliminer les matières en suspension.
Récupère l'eau trouble.
Rende acqua cristallina ed elimina le particelle in superficie.
Recupera l'acqua torbida.

PRODUCTOS COMPLEMENTARIOS COMPLEMENTARY PRODUCTS
PRODUITS COMPLÉMENTAIRES PRODOTTI COMPLEMENTARI

DESINCRUSTANTE DE SUPERFICIE
SURFACE DESCALER
DÉTARTRANT DE SURFACE
PULITORE SUPERFICI D'ACQUA

DETREATANT SURFACE

LÍQUIDO LIQUID LIQUIDE LIQUIDO



Ref. **76046** 1 L pack 12



Para eliminar incrustaciones de cal.
 To eliminate lime scales.
 Pour éliminer les incrustations calcaires.
 Per evitare la incrostazione del calcare.

LIMPIADOR DE BORDES
WATERLINE CLEANER
NETTOYANT LIGNE D'EAU
PULITORE SUPERFICI D'ACQUA

NETTOYANT LIGNE D'EAU

LÍQUIDO LIQUID LIQUIDE LIQUIDO



Ref. **76047** 1 L pack 12



Para eliminar la suciedad de la línea de flotación.
 To eliminate the dirt on the waterline.
 Pour éliminer la saleté sur la ligne d'eau.
 Per eliminare particelle in superficie.



ANTICALCÁREO ANTI LIME
ANTI-CALCAIRE ANTICALCARE

ANTICALC

LÍQUIDO LIQUID LIQUIDE LIQUIDO



Ref. **76049** 1 L pack 12



Ref. **76048** 5 L pack 4



Para evitar la formación de cal.
 Secuestrante de metales (hierro, cobre...)
 To prevent lime formation.
 Metal Sequestering Agents (iron, copper...)
 Pour éviter la formation de calcaire.
 Séquestrant de métaux (fer, cuivre, etc.)
 Evita la formazione del calcare.
 Sequestrante di metalli (ferro, rame)

PRODUCTO QUÍMICO PARA EL INVIERNO CHEMICAL PRODUCTS FOR WINTER
PRODUITS CHIMIQUES POUR L'HIVER PRODOTTI CHIMICI PER L'INVERNO

Le facilitará la puesta en marcha de la piscina después del invierno, evitando la formación de algas y de cal.
 Realizar el proceso cuando la temperatura del agua de la piscina sea inferior a 15°C.

- 1) Limpiar la piscina.
- 2) Ajustar el pH entre 7,2 - 7,6
- 3) Realizar una cloración de choque
- 4) Dejar en funcionamiento el fi ltr o hasta el día siguiente 5) Realizar una limpieza del fi ltr o
- 6) Añadir el invernador

It makes easier for you the start-up of the pool after winter, avoiding algae and lime formation.

Please carry out the following if the temperature of the water drops below 15°C.

- 1) Clean the swimming pool
- 2) Set the pH balance between 7.2 – 7.6
- 3) Carry out a chlorine crash course
- 4) Leave the fi ltr running until the following day
- 5) Clean the fi ltr
- 6) Add the winterizing agent

Vous facilite la mise en route de la piscine après l'hiver en évitant la formation d'algues et de calcaire.
 Réaliser le processus lorsque la température de l'eau de la piscine est inférieure à 15°C.

- 1) Nettoyer la piscine
- 2) Ajuster le pH entre 7,2 - 7,6
- 3) Réaliser une chloration de choc
- 4) Laisser fonctionner le fi ltr e jusqu'au lendemain
- 5) Nettoyer le fi ltr e
- 6) Ajouter l'hivernant

Renderà piú semplice l'inizio della nuova Stagione, dopo l'inverno, evitando la formazione di alghe e calcare.

Realizzare la procedura quando la temperatura dell'acqua della piscina è inferiore a 15°C.

- 1) Pulire la piscina
- 2) Regolare il pH tra 7,2 e 7,6
- 3) Eff ettuate una clorazione d'urto
- 4) Lasciare in funzione il fi ltr o fino al giorno successivo
- 5) Eff ettuate una pulizia del fi ltr o
- 6) Aggiungere lo svernante



INVERNADOR WINTERISER
HIVERNAGE TRATTAMENTO PER L'INVERNO

HIVERNAGE

LÍQUIDO LIQUID LIQUIDE LIQUIDO



Ref. **76050** 1 L pack 12



Ref. **76051** 5 L pack 4



INVERNADOR CONCENTRADO CONCENTRATED
WINTERISER HIVERNAGE CONCENTRÉ
TRATTAMENTO PER L'INVERNO CONCENTRATO

HIVERNAGE CONCENTRÉ

LÍQUIDO LIQUID LIQUIDE LIQUIDO



Ref. **76017** 1 L pack 12



INVERNADOR CON BOYA FLOAT WINTERISER
BOUÉE HIVERNAGE TRATTAMENTO PER
L'INVERNO GALLEGGIANTE

HIVER FLOAT

PASTILLAS TABLETS PASTILLES PASTIGLIE



Ref. **76052** 2 Kg pack 6



PODS HIDROSOLUBLES WATER SOLUBLE PODS HYDROSOLUBLE PODS PODS IDROSOLUBILE



1	2	3	4
Natural Clarifier	Algae Killer	MultiProtect	MultiProtect especial filtros de cartucho



1 POD ---> 50 m³



ALGAE KILLER

ALGICIDA ALGICIDE ALGICIDE ALGHICIDA

Ref. **PALG8** 8 x 20 ml **DIS** pack 6 8 412081 273112

NATURAL CLARIFIER

FLOCULANTE FLOCCULENT FLOCCULANT FLOCCULANTE

Ref. **PNCL4** 4 x 30 g **DIS** pack 8 8 412081 273099



MULTIPROTECT

Algicida + Floculante + Antigrasa
Algicide + Flocculent + Anti-grease
Algicide + Flocculant + Anti-graisse
Alghicida + Flocculante + Antigrasso

Ref. **PTOT8** 8 x 30 g **DIS** pack 6 8 412081 273105



MULTIPROTECT FOR CARTRIDGE FILTER

Algicida + Floculante + Antigrasa (Filtro de cartucho)
Algicide + Flocculent + Anti-grease (cartridge filter)
Algicide + Flocculant + Anti-graisse (Epurateur à cartouche)
Alghicida + Flocculante + Antigrasso (Filtri a cartuccia)

Ref. **PTOT8C** 8 x 30 g **DIS** pack 6 8 412081 273136

REF. 90175

DIS PACK 14



Repulsivo Anti Insectos a base de aceites esenciales 100% naturales. Dosis cada de 3 pastillas de 30g.
Répulsif Anti Insectes à base d'huiles essentielles 100% naturelles. Doseur de 3 pastilles de 30g.

Anti Insect repellent using 100% natural essential oils. 30 g 3 tablet dosifier.

Repellente anti-insetti a base di oli essenziali 100% naturali. Dosatore di 3 pastiglie da 30g.



REF. 90178

DIS PACK 12



Repulsivo Anti Insectos a base de aceites esenciales 100% naturales. Caja de 6 pastillas de 30g.
Répulsif Anti Insectes à base d'huiles essentielles 100% naturelles. Boite carton de 6 pastilles de 30g.

Anti Insect repellent using 100% natural essential oils. 30g 6 tablet box.

Repellente anti-insetti a base di oli essenziali 100% naturali. Confezione di 6 pastiglie da 30g.



REF. 90147

DIS PACK 12



Stop Aguas Verdes
Recupera las aguas verdes gracias a una nueva generación de polimeros hidrosolubles. Caja de 6 pastillas de 20g.

Stop Eaux Vertes

Il récupère les eaux vertes grâce à une nouvelle génération de polymères hydrosolubles. Boite carton de 6 pastilles de 20g.

Stop Green Waters
Get back the green waters of your pool thanks to a new generation of water soluble polymers. 20g 6 tablet box.

Stop Acque Verdi

Recupera le acque verdi grazie ad una nuova generazione di polimeri idrosolubili. Confezione di 6 pastiglie da 20g.



REF. 90143

DIS PACK 12



Stop Aguas Turbias
Recupera las aguas turbias, y consigue un agua limpia y cristalina. Caja de 6 pastillas de 30g.

Stop Eaux Troubles

Traite les eaux troubles, et rend l'eau propre et cristalline. Boite carton de 6 pastilles de 30g.

Stop Cloudy Waters
Get back the cloudy waters to obtain a crystal-clear water. 30g 6 tablet box.

Stop Acque Torbide

Recupera le acque torbide, la sua efficacia permette di avere un'acqua limpida e cristallina. Confezione di 6 pastiglie da 30g.



REF. SATC6

DIS PACK 12



Stop Aguas Turbias
Recupera las aguas turbias, y consigue un agua limpia y cristalina. Para piscinas con filtro de cartucho. Caja de 6 pastillas de 17g.

Stop Eaux Troubles

Traite les eaux troubles, et rend l'eau propre et cristalline. Pour les piscines avec filtre à cartouche. Boite carton de 6 pastilles de 17g.

Stop Cloudy Waters
Get back the cloudy waters to obtain a crystal-clear water. For pools with cartridge filter. 17g 6 tablet box.

Stop Acque Torbide

Recupera le acque torbide, la sua efficacia permette di avere un'acqua limpida e cristallina. Per le piscine con filtro a cartuccia. Confezione di 6 pastiglie da 17g.

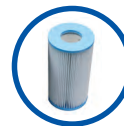

producto químico **chemicals**

- Solución de tratamiento "Todo en Uno". Ideal piscinas elevadas con o sin filtración. Tratamiento mensual.
- 4 Acciones: Higienizante, Antibacterias, Antialgas y Floculante
- No hay manipulación directa de producto químico.

No perjudica la filtración gracias a su forma optimizada que deja el circuito de agua intacto. El POOLP'O sube a la superficie una vez acabado el producto químico, avisando de la necesidad de empezar un nuevo tratamiento.

- Solution de traitement "Tout en Un". Idéal Piscines hors-sol avec ou sans filtration. Traitement mensuel.

- 4 Actions: Hygiénisant, Anti-bactéries, Anti-algues, Flocculant.
- Pas de manipulation directe de produit chimique.

Ne gêne pas la filtration grâce à sa forme optimisée qui laisse le circuit de l'eau intact. Ne gêne pas le volet du skimmer de part sa petite taille. Le POOLP'O remonte à la surface une fois le produit consommé vous avisant de la nécessité de recommencer un traitement.

- Treatment solution "All in One" for Above ground Pools with and without filtration. Monthly treatment.

- 4 actions: Sanitizing, Anti-bacteria, Anti-algae and Flocculant.
- No direct handling of chemical product. It does not obstruct filtration thanks to its form optimized – which leaves the circuit of water intact. It goes up once product finished, so you know you should start a new treatment.

- Soluzione "Tutto in uno". Adatto per piscine fuori terra con o senza filtrazione. Trattamento mensile

- 4 azioni: Igienizzanti, Anti- batteri, Antialghe e Flocculante
- Non c'è contatto diretto con il prodotto chimico. Non danneggia la filtrazione grazie alla sua forma che lascia libero il circuito dell'acqua. El Poolp'o sale in superficie una volta terminato il prodotto chimico, avvisando della necessità di dover iniziare un nuovo trattamento



REF. 08012

BX PACK 16



POOLP'O 0-10m³ (250g)
POOLP'O 0-10m³ (250g)

POOLP'O 0-10m³ (250g)
POOLP'O 0-10m³ (250g)

REF. 08112

DIS 18



Display **POOLP'O 0-10m³ (250g)**
18 unidades
POOLP'O 0-10 m³ (250g) Display 18
unités

Display **POOLP'O 0-10 m³ (250g)**
18 units
Display **POOLP'O 0-10 m³ (250g)**
18 unità



REF. 08013A

BX PACK 16



POOLP'O 10-20m³ (500g)
POOLP'O 10-20m³ (500g)

POOLP'O 10-20m³ (500g)
POOLP'O 10-20m³ (500g)

REF. 08113

DIS 18



Display **POOLP'O 10-20m³ (500g)**
18 unidades
POOLP'O 10-20m³ (500g) Display
18 unités

Display **POOLP'O 10-20m³ (500g)**
18 units
Display **POOLP'O 10-20m³ (500g)**
18 unità



REF. 08099A

BX PACK 9



POOLP'O 10-30m³ (700g)
Dosificador flotante con tratamiento
químico. Duración 3 semanas

POOLP'O 10-30m³ (700g)
Chemical treatment floating dispenser.
3 weeks

POOLP'O 10-30m³ (700g)
Doseur flottant chimique tout en un.
Durée 3 semaines.

POOLP'O 10-30m³ (700g)
Dispenser galleggiante con
trattamento chimici. 3 settimane.

KITS PISCINA POOL KITS

KITS POUR PISCINE KIT PER PISCINE

REF. 76053

PACK 12



Kit para piscina de 0 a 5m³

Cloro lento pastillas de 5 g - 500 g
+ Dosificador + Pelota

Kit pour piscine de 0 à 5m³

Chlore lent pastilles de 5 g - 500 g
+ Doseur + Ballon

Kit for 0-5m³ pool

Trichlorine 5g tablets - 500 g +
Dispenser + Ball

Kit per piscine da 0 a 5m³

Cloro lento pastiglie da 5 g - 500g +
dosatore + palla gonfiabile



REF. 76054

PACK 6



Kit para piscina de 5 a 15m³

Multifunciones pastillas 20g, 1Kg +
Dosificador + Termómetro + Analizador
+ Manguitos + Kit reparación liner

Kit pour piscine de 5 à 15m³

Multifonction pastilles 20g, 1 kg + Doseur +
Thermomètre + Trousse
d'analyse + Brassards + Kit réparation liner

Kit for 5-15m³ pool

Multiactions 20g tablets, 1Kg +
Dispenser + Thermometer + Test kit
+ Arm-bands + Liner repair kit

Kit per piscine da 5 a 15m³

4 azioni pastiglie da 20g, formato 1 Kg
+ Dosatore + termometro + Kit analisi
+ Bracciali + Kit riparazione liner



REF. KTSPA

DIS PACK 12



Kit tratamiento para Spa

Spa desinfectante 20g x4 + pH plus
20g x2 + pH menos 30g x2

Kit traitement pour Spa

Spa desinfect 20g x4 + augmente
pH 20g x2 + baisse pH 30g x2

Kit with chemical treatment for Spa

Spa disinfect 20g x4 + pH reduce 20g x2 +
pH increase 30g x2

Kit tratamiento per Spa

disinfezione Spa 20g x4 + incrementatore
pH 20g x2+ riduttore pH 30g x2





JUNIOR POOL

REF. KKP525

DIS PACK 18



Kit tratamiento químico para piscinas pequeñas sin filtración
5 bolsas de 25 ml
Kit traitement chimie pour petites bassins sans filtration
5 x 25 ml

Disinfection for small pools without filter
5 x 25 ml
Kit trattamento per piscina piccola senza filtrazione
5 x 25 ml



TESTERS DIGITALES DIGITAL TESTERS TESTEURS DIGITAL TESTER DIGITALE



REF. 40817

BL PACK 12



Recambio para el Aquacheck True Test: 25 tiras analíticas.

Aquacheck True Test refill: 25 test strips.

Recharge pour Aquacheck TruTest.: 25 languettes d'analyse

Ricarica di Aquacheck TruTest: 25 strisce di analisi.



REF. 38813

CS PACK 6



Aquacheck
Lector digital de tiras de análisis TruTest. Analiza los niveles de cloro/bromo libre, valor pH y alcalinidad total.

Aquacheck
Digital Test Strip Reader. Tests for: Free Chlorine, pH, Total Alkalinity.

Aquacheck
Lecteur digital de bandelettes d'analyse TruTest. Résultats de Chlore/Brome libre, pH et Alcalinité totale.

Aquacheck
Digital Test striscia lettore TruTest: cloro / bromo-libero, il pH e l'alcalinità totale.

REF. 40068

1/8 BL PACK 16



Análisis cloro + pH + alcalinidad
(50 tiras).

Chlorine + pH + alkalinity analysis
(50 strips).

Analyse chlore + pH + alcalinité
(50 languettes).

Analisi cloro + pH + alcalinità
(50 strisce).



REF. 40069

BX PACK 12



Analiza el nivel de sal en agua
(16 tiras).

Salt level in water analysis
(16 strips).

Analyse le niveau de Sel de l'eau
(16 languettes).

Analizza il livello di sale nell'acqua
(16 strisce).

**MONODOSIS MONODOSE
MONODOSE MONODOSI**



REF. UFG90

DIS PACK 36



Ultraflock
Gel floculante en monodosis de 90g.

Ultraflock
Flocculant Gel 90g pods.

Ultraflock
Floculant Gel gousse de 90g.

Ultraflock
90g flocculante gel.

ANALIZADORES TEST KITS
TROUSSES D'ANALYSE KIT TEST

REF. 40060

BL PACK 16



Analizador de cloro/bromo + pH (Oto/Phenol)

Trousse chlore/brome + pH (Oto/Phénol)

Test kit chlorine/bromine + pH (Oto/Phenol)

Kit analisi cloro/bromo + pH (oto/Phenol)



REF. 40061

BL PACK 12



Recambio Oto/Phenol
Recharge Oto/Phénol

Refi II Oto/Phenol
Ricambio Oto/Phenol



REF. 40062

DIS 1/8 CS PACK 24



Comparador cloro + pH - pastillas DPD1
Trousse chlore + pH - pastilles DPD1

Test kit chlorine + pH - DPD1 tablets
Kit analisi cloro + ph - pastiglie DPD1



REF. 40063

DIS 1/8 BL PACK 24



Recambio pastillas DPD1
Recharge pastilles DPD1

Refi II DPD1 tablets
Ricarica pastiglie DPD1

produits d'entretien | prodotti chimici



REF. 40066

DIS 1/8 CS PACK 24



Kit de análisis de oxígeno/bromo + pH -
pastillas DPD4

Trousse de oxygène/brome + pH pastilles
DPD4

Oxygen / bromine + pH test kit - DPD4
tablets

Kit analisi ossigeno/bromo + pH
pastiglie DPD4



REF. 40067

DIS 1/8 BL PACK 24



Recambio pastillas DPD4

Recharge pastilles DPD4

Refi II DPD4 tablets

Ricarica pastiglie DPD4

material plv pos material matériels plv materiale pos



EXPOSITOR PISCINA CHAPA STEEL POOL EXHIBITOR EXPOSANTS PISCINE ACIER EXPOSITORI PISCINE PARETI IN ACCIAIO



TOTEMS CARTÓN CARDBOARD TOTEMS TOTEMS CARTON TOTEMS CARTONE

FOLLETOS LEAFLETS DÉPLIANTS VOLANTINI



EXPOSITOR ROBOTS
ROBOTS EXHIBITOR
EXPOSANTS ROBOTS
EXPOSITORI ROBOTS

TOTEM ENTERRADAS
IN GROUND POOLS TOTEM
TOTEM PISCINES ENTERRÉES
TOTEM PISCINE INTERRATA



PISCINA DE EXPOSICIÓN
EXHIBITOR WOODEN POOL
EXPOSANT PISCINE BOIS
EXPOSITORI PISCINA IN LEGNO

