









Pools



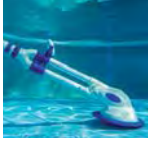

Pools

índice index sommaire indice

INTRODUCCIÓN INTRODUCTION INTRODUCTION INTRODUZIONE		Pag. 02
PISCINAS ENTERRADAS IN-GROUND POOLS PISCINE ENTERRÉ PISCINE INTERRATA		Pag. 06
PISCINAS DE MADERA WOODEN POOL PISCINE BOIS PISCINA IN LEGNO		Pag. 12
PISCINAS DE ACERO STEEL WALL POOLS PISCINES PAROI ACIER PISCINA IN ACCIAIO		Pag. 18
PISCINAS INFANTILES CHILDREN POOLS PISCINES POUR ENFANTS PISCINE PER BAMBINI		Pag. 56
COMPLEMENTOS COMPLEMENTES COMPLEMENTS COMPLEMENTI		Pag. 58
MATERIAL DE LIMPIEZA CLEANING MATERIAL MATÉRIEL DE NETTOYAGE MATERIALE DI PULIZIA		Pag. 90
PRODUCTO QUÍMICO CHEMICALS PRODUITS D'ENTRETIEN CHIMICI		Pag. 116

PISCINAS POOLS PISCINES PISCINAS



SOBRE SUELO ON-GROUND HORS SOL FUORI TERRA

ESCALERA
LADDER
ÉCHELLE
SCALA



MONOBLOC DE FILTRACIÓN FILTRATION KIT
KIT DE FILTRATION FILTRO MONOBLOCCO



ELECTRÓLISIS DE SAL SALT CHLORINATOR
ELECTROLYSE AU SEL ELETTROLISI SALINA



DUCHAS SHOWERS
DOUCHES DOCCIA



ROBOTS ROBOTS
ROBOTS ROBOTS



BOMBAS DE CALOR HEAT PUMPS
POMPE À CHALEUR POMPE DI CALORE



LIMPIAFONDOS ELÉCTRICO
ELECTRIC CLEANERS
NETTOYEUR DE FOND ÉLECTRIQUE
PULITORE ELETTRICO PER FONDO PISCINA

MATERIAL DE LIMPIEZA CLEANING MATERIAL
MATÉRIEL DE NETTOYAGE MATERIALE DI PULIZIA



BOX MIXTO DE TERMÓMETROS
MIXED BOX WITH THERMOMETERS
BOX MIXTE DE THERMOMÈTRES
CONTENITORE CON TERMOMETRI



PRODUCTO QUÍMICO
CHEMICALS
PRODUITS D'ENTRETIEN
PRODOTTI CHIMICI





Presentación de la empresa

Gre es una empresa con más de 50 años de experiencia en la fabricación de piscinas elevadas.

Como empresa pionera en el sector, somos especialistas y líderes a nivel europeo.

Nuestra apuesta clara por la calidad y seguridad de todos nuestros productos, nos convierte en la referencia fundamental del mercado.

Nuestra empresa ofrece una amplia gama de productos: piscinas elevadas de diferentes formatos y acabados, una completa línea de accesorios para su equipamiento y mantenimiento y una serie de productos químicos diseñados específicamente para el agua de la piscina.

Con el ánimo siempre, de satisfacer al cliente, Gre ha diseñado una estrategia de servicios, cuyo objetivo es ofrecer una solución integral. Nuestra amplia red de Servicios Técnicos, así como nuestros Departamentos de Atención al Cliente, son la mejor prueba de ello. Estos servicios nos permiten asesorarle sobre la opción de piscina y equipamiento más adecuados a sus necesidades.

Présentation de l'entreprise

Gré est une société spécialisée dans la fabrication de piscines hors-sol.

Pionnière dans le secteur, notre entreprise est SPÉCIALISTE et LEADER en EUROPE.

Notre pari sur la QUALITÉ et la SÉCURITÉ de tous nos produits nous permet d'être la principale RÉFÉRENCE du marché.

Notre entreprise offre une LARGE GAMME de produits, allant des piscines hors-sol aux tailles et finitions diverses et variées, jusqu'à un éventail complet des accessoires nécessaires à l'équipement et à l'entretien, et une gamme de produits chimiques conçus spécifiquement pour l'eau de la piscine.

Toujours dans le but de satisfaire le client, Gre a conçu une stratégie de SERVICES dont l'objectif est d'offrir une réponse et une solution complètes: un important réseau de Services Techniques ainsi qu'un Service Clients. Ces services nous permettent de vous conseiller sur le choix tant de votre piscine que de l'équipement le plus approprié à vos besoins.

Company presentation

Gre is a company with more than 50 years experience in manufacturing above-ground pools.

As a pioneer company on its field, we are SPECIALISTS and LEADERS within the European market.

We are considered to be a fundamental market REFERENCE as a result of our clear wager on QUALITY and SECURITY of all our products.

Our company offers a WIDE RANGE of products which includes: different sizes and finishes aboveground pools, a complete range of accessories for their equipment and maintenance and a number of swimming pool chemicals designed specifically for the pool water.

Bearing in mind our customers satisfaction, Gre has designed an important SERVICES strategy whose aim is to offer an integral solution. Our wide network of Technical Services and our Customer Service Departments are the best proof of that. These services help us to identify our customers needs and to advice them on the best pool and equipment according to those needs.

Presentazione dell'azienda

La Gre è un'azienda con oltre 50 anni di esperienza nella produzione di piscine smontabili su terra.

Come impresa pioniera nel settore, siamo SPECIALISTI e LEADER a livello EUROPEO.

La nostra chiara scommessa sulla QUALITÀ e sulla SICUREZZA di tutti i nostri prodotti, fa di noi il RIFERIMENTO fondamentale del mercato.

La nostra società offre una VASTA GAMMA di prodotti: piscine elevate di diversi formati e rifiniture, una completa linea di accessori per l'attrezzatura e la manutenzione e una serie di prodotti chimici pensati specificamente per l'acqua della piscina.

Sempre con l'intenzione di soddisfare il cliente, la Gre ha progettato una strategia di SERVIZI il cui scopo è quello di offrire una soluzione integrale. La nostra vasta rete di Servizi Tecnici, così come i nostri Reparti di Servizio al Cliente, ne sono la miglior prova. Tali servizi ci consentono di dare consulenza sulla scelta della piscina e dell'equipaggiamento più idoneo alle vostre necessità.

Certificaciones Certifications Certifications Certificazioni

MADE IN EUROPE

Todas las piscinas fabricadas por Manufacturas GRE S.A. Son de origen CE - Comunidad Europea.

Toutes les piscines fabriquées par Manufacturas Gre S.A. sont d'Origine CE - Communauté Européenne.

All the pools manufactured by Manufacturas Gre S.A. are of EC - European Community origin.

Tutte le piscine prodotte da Manufacturas Gre S.A. sono di origine CE - Comunità Europea.



ISO 9001

Les processus utilisés pour la conception, la fabrication et la commercialisation de piscines hors-sol de Manufacturas Gre S.A., ainsi que la commercialisation de produits associés, sont certifiés conformes aux critères de système de Gestion de Qualité selon la norme internationale ISO9001:2000.

Los procesos utilizados para el diseño, la fabricación y comercialización de piscinas desmontables de Manufacturas Gre S.A., así como la comercialización de productos asociados, están certificados siguiendo los criterios de sistema de Gestión de Calidad según la norma internacional ISO9001:2000, lo cual garantiza regularidad y control en la calidad de nuestros productos y procesos.

The processes used for the design, manufacturing and commercialisation of dismountable pools by Manufacturas Gre S.A., as well as the commercialisation of associated products, are certified according to the Quality System according to the international ISO9001:2000 standard, which guarantees regularity and control in the quality of our products and processes.

I processi utilizzati per la progettazione, la costruzione e la vendita di piscine smontabili a marchio Manufacturas Gre S.A., oltre alla vendita di prodotti ad esse associati, sono certificati in base ai criteri del sistema di Gestione della Qualità secondo la norma internazionale ISO9001:2000, ciò garantisce la regolarità e il controllo della qualità dei nostri prodotti e dei processi produttivi.



ISO 14001

Gracias a la implantación de un Sistema de Gestión Ambiental según la norma internacional ISO 14001: 2004, Manufacturas Gre S.A. se posiciona como una empresa socialmente responsable. Entre otras ventajas ambientales, optimizamos la gestión de recursos y residuos, reduciendo los impactos ambientales negativos derivados de nuestra actividad o aquellos riesgos asociados a situaciones accidentales.

Grâce à l'implémentation d'un Système de Gestion Environnementale conformément à la norme internationale ISO 14001:2004, Manufacturas Gre S.A. se positionne comme une entreprise socialement responsable. Parmi de nombreux avantages environnementaux, nous optimisons la gestion des ressources et des déchets, réduisant ainsi les impacts environnementaux négatifs et dérivés de notre activité ou les risques associés à des situations d'accidents.

Thanks to the implantation of an Environmental Management System according to the international ISO 14001:2004 standard, Manufacturas Gre S.A. is positioned as a socially responsible company. Among other environmental advantages, we optimise resources and residues, reducing negative environmental impact derived from our activity or those risks associated to accidental situations.

Grazie all'introduzione di un Sistema di Gestione Ambientale secondo la norma internazionale ISO 14001:2004, Manufacturas Gre S.A. si classifica tra le aziende socialmente responsabili. Ciò comporta vantaggi per l'ambiente come l'ottimizzazione della gestione delle risorse, la riduzione degli impatti ambientali negativi derivanti dall'attività di produzione o dei rischi associati a eventi accidentali.



ARBITRAJE DE CONSUMO / CONSUMER ARBITRATION / ARBITRAGE DE CONSOMMATION / ARBITRATO DI CONSUMO

Manufacturas Gre S.A. está adherido a la Junta Arbitral de Consumo como muestra de predisposición a la solución amistosa de cualquier tipo de reclamación por parte de sus clientes.

Manufacturas Gre S.A. est membre du bureau d'Arbitrage de Consommation, comme preuve de prédisposition à la solution amiable de tout type de réclamation de la part de ses clients.

Manufacturas Gre S.A. is adhered to the Consumer Arbitration Directorate evidencing predisposition to a friendly solution to any type of reclamation from its clients.

Manufacturas Gre S.A. aderisce alla Giunta Arbitrale di Consumo come segnale di predisposizione alla soluzione amichevole di qualsiasi tipo di reclamo da parte dei propri clienti.



CE

Los productos distribuidos por Manufacturas Gre S.A. con el marcado CE cumplen todos los requisitos legales vigentes en Europa.

Les produits distribués par Manufacturas Gre S.A. dotés du marquage CE répondent à toutes les obligations légales en vigueur en Europe.

The products distributed by Manufacturas Gre S.A., with the CE marking comply with all the legal requirements in force in Europe.

I prodotti distribuiti da Manufacturas Gre S.A. con il marchio CE rispettano tutti i requisiti legali vigenti in Europa.





NF P 90 - 303, NF P 90 - 316, NF P 90 - 317, NF P 90 - 318, NF P 90 - 319

Estas certificaciones garantizan que las piscinas, filtros y escaleras fabricados y/o distribuidos por Manufacturas Gre S.A. cumplen con las normativas de seguridad establecidas.

These certifications guarantee that the pools, filters and stepladders manufactured and/or commercialised by Manufacturas Gre S.A. comply with the established safety regulations.

Ces certifications garantissent que les piscines, les filtres et les échelles fabriqués et/ou distribués par Manufacturas Gre S.A. respectent les normes de sécurité établies.

Queste certificazioni garantiscono che le piscine, i filtri e le scalette prodotti e/o distribuiti da Manufacturas Gre S.A. rispettano le normative di sicurezza previste.



ECOEMBES

Manufacturas Gre S.A. está adherida a un sistema de recogida y reciclaje selectivo de los materiales que pone en el mercado con el fin último de preservar el medio ambiente.

Manufacturas Gre S.A. is adhered to a system for the selective collection and recycling of the materials it puts on the market in order to conserve the environment.

Manufacturas Gre S.A. est membre d'un système de collecte et de recyclage sélectif des matériaux qu'elle met sur le marché, dans le but de préserver l'environnement.

Manufacturas Gre S.A. aderisce a un sistema di raccolta differenziata e riciclaggio dei materiali immessi sul mercato, in un'ottica di preservazione dell'ambiente.



REACH

Manufacturas Gre S.A. cumple con el reglamento Reach asegurando que todas las sustancias químicas que comercializa están registradas.

Manufacturas Gre S.A. complies with the Reach regulation ensuring that all the chemical substances it commercialises are registered.

Manufacturas Gre S.A. respecte le règlement Reach, qui garantit que toutes les substances chimiques qu'elle commercialise sont enregistrées.

Manufacturas Gre S.A. rispetta il regolamento Reach garantendo la registrazione di tutte le sostanze chimiche immesse sul mercato dall'azienda.

RoHS

ROHS

Manufacturas Gre S.A. cumple esta directiva para proteger el medio ambiente y la salud de las personas, evitando el uso de determinadas sustancias en aparatos eléctricos y electrónicos.

Manufacturas Gre S.A. complies with this directive to protect the environment and health of persons, avoiding the use of determined substances in electrical and electronic devices.

Manufacturas Gre S.A. respecte cette directive afin de protéger l'environnement et la santé des personnes, évitant ainsi l'utilisation de substances déterminées dans les appareils électriques et électroniques.

Manufacturas Gre S.A. rispetta questa normativa per proteggere l'ambiente e la salute delle persone, evitando l'utilizzo di determinate sostanze su dispositivi elettrici ed elettronici.



PEFC

Manufacturas Gre S.A. cumple con los requisitos del Estándar de Cadena de Custodia de Productos Forestales PEFC ST 2002:2010

Manufacturas Gre S.A. complies with the requirements of the Programme for the Endorsement of Forest Certification PEFC ST 2002:2010

Manufacturas Gre S.A. respecte les conditions du Standard de la Chaîne de Contrôle de Produits Forestiers PEFC ST 2002:2010.

Manufacturas Gre S.A. rispetta i requisiti previsti dallo Standard della catena di custodia dei prodotti forestali PEFC ST 2002:2010.

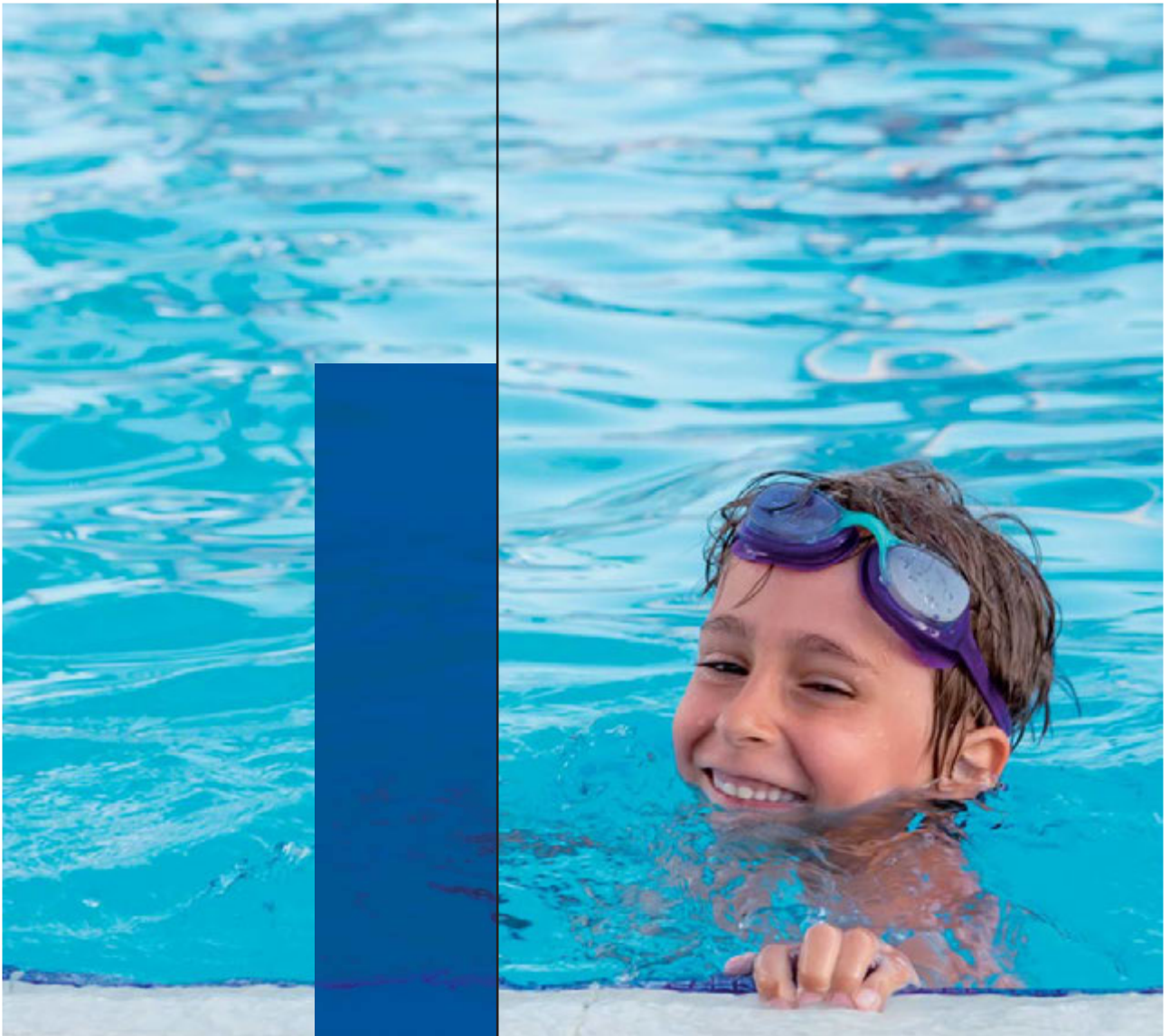

PISCINA ENTERRADA DE PARED DE ACERO

LINER: Tratamiento Anti-ultravioleta que retrasa el envejecimiento del P.V.C.

CHAPA: Laminada en frío con tratamiento de galvanización, fosfatación e imprimación.

Troquelada para skimmer, válvulas de retorno y limpiafondos y focos.

PISCINE ENTERRÉE PAROI ACIER

LINER: Traitement anti-ultraviolets contre le vieillissement du P.V.C.

TÔLE: Tôle laminée à froid et traitée par galvanisation, phosphatage, couche d'apprêt et laquage.

Découpage pour le skimmer, la buse de refoulement et la prise balai. Prédécoupe pour les projecteurs.

IN-GROUND STEEL WALL POOL

LINER: Anti-ultraviolet treatment to slow down P.V.C aging.

PLATE: Galvanized, phosphatized, primed and lacquered cold-rolled plate.

Die cut for skimmer, return valve and cleaner openings and lights.

PISCINE INTERRATA CON PARETI IN ACCIAIO

LINER: Trattamento Anti-ultravioletti - Ritarda l'invecchiamento del P.V.C.

PANNELLO: Laminata a freddo con trattamento di galvanizzazione, fosfatazione e preparazione.

Stampigliatura per Skimmer, valvola di ritorno e puliscifondi e spot.



**MADE
IN
EU**

in-ground pool

serie

MADAGASCAR



EAN 13

Model	Dimensions (cm)	Depth (cm)	Volume (l)	Weight (kg)	Box Dimensions (cm)	Flow Rate (m³/h)	Filter	EAN 13
KPEOV8159	800x470	150	40.140	217/228	1/120x80 1/90x80	10	✓	8 412081 258874
KPEOV7359	730x375	150	29.225	189/228	1/120x80 1/90x80	10	✓	8 412081 258881
KPEOV6159	610x375	150	24.420	164/228	1/120x80 1/90x80	10	✓	8 412081 258898
KPEOV5059	500x300	150	16.015	139/228	1/120x80 1/90x80	8	✓	8 412081 258904



MEDIDA PISCINA
POOL SIZE
DIMENSIONS PISCINE
MISURA PISCINA

ESPACIO NECESARIO
NECESSARY SPACE
ESPACE NECESSAIRE
SPAZIO NECESSARIO

Model	Pool Size (cm)	Necessary Space (cm)
KPEOV8159	800x470x150	1010x670x165
KPEOV7359	730x375x150	930x575x165
KPEOV6159	610x375x150	810x575x165
KPEOV5059	500x300x150	700x500x165



Liner PVC azul
75/100
PVC blue liner
75/100
Liner bleu PVC
75/100
Liner blu PVC
75/100

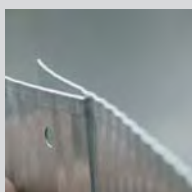

Chapa prelacada
70/100
Prelacquered steel
70/100
Tôle prélaquée
70/100
Lamiere laccata
70/100

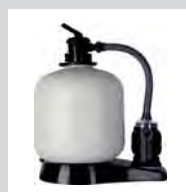

Depuradora arena
(Caudal grupo 10/8 m³/h)
Sand filter
(Flow group 10/8 m³/h)
Filtre à sable
(Débit groupe 10/8 m³/h)
Filtro a sabbia
(Portata gruppo 10/8 m³/h)



PLREB BXL PACK 1



Proyector LED BLANCO para piscina enterrada.
Projecteur LED BLANCHE pour piscine enterrée.

WHITE LED projector for in-ground pools.
Faretto LED BIANCO per piscina interrata.

PLREC BXL PACK 1



Proyector LED COLOR para piscina enterrada.
Projecteur LED de COULEUR pour piscine enterrée.

COLOR LED projector for in-ground pools.
Faretto LED MULTICOLOR per piscina interrata.



EAN 13

KPE4559

Ø460 cm

150 cm

22.590 l

126/228 kg

1/120x80
1/90x80

8m³/h

√

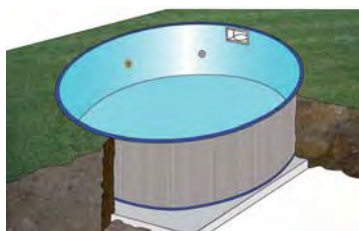

MEDIDA PISCINA
POOL SIZE
DIMENSIONS PISCINE
MISURA PISCINA

ESPACIO NECESARIO
NECESSARY SPACE
ESPACE NECESSAIRE
SPAZIO NECESSARIO

KPE4559

Ø460x150 cm

Ø660x165 cm



Escalera:
4 peldaños - Inox.
Ladder:
4 steps - Stainless steel
Échelle:
4 marches - Acier inoxydable
Scala:
4 gradini - Inox



Manta protectora
(Poliéster)
Bottom protectiveblanket
(Polyester)
Tapis de sol en feutre
(Polyester)
Telo di protezione
(Poliestere)



Skimmer, manguera,
racordería...
Skimmer, hose,
fittings...
Skimmer, tuyau,
raccords...
Skimmer, tubo,
racordería...

in-ground pool

serie

SUMATRA



EAN 13

Model	Dimensions (cm)	Height (cm)	Capacity (l)	Weight (kg)	Box Size (cm)	Flow (m³/h)	Accessories	EAN 13
KPEOV8127	800x470	120	30.990	193/227	1/120x80 1/90x80	10m³/h	√	8 4 12081 258928
KPEOV7327	730x375	120	22.560	173/227	1/120x80 1/90x80	10m³/h	√	8 4 12081 258935
KPEOV6127	610x375	120	18.855	154/227	1/120x80 1/90x80	10m³/h	√	8 4 12081 258942
KPEOV5027	500x300	120	12.360	134/227	1/120x80 1/90x80	8m³/h	√	8 4 12081 258959



MEDIDA PISCINA
POOL SIZE
DIMENSIONS PISCINE
MISURA PISCINA

ESPACIO NECESARIO
NECESSARY SPACE
ESPACE NECESSAIRE
SPAZIO NECESSARIO

Model	Dimensions (cm)	Required Space (cm)
KPEOV8127	800x470x120	1010x670x135
KPEOV7327	730x375x120	930x575x135
KPEOV6127	610x375x120	810x575x135
KPEOV5027	500x300x120	700x500x135



Liner PVC azul
60/100
PVC blue liner
60/100
Liner bleu PVC
60/100
Liner blu PVC
60/100

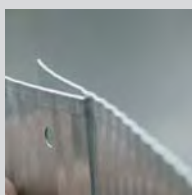

Chapa prelacada
60/100
Prelacquered steel
60/100
Tôle prélaquée
60/100
Lamiere laccata
60/100

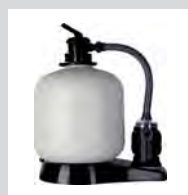

Depuradora arena
(Caudal grupo 10/8 m³/h)
Sand filter
(Flow group 10/8 m³/h)
Filtre à sable
(Débit groupe 10/8 m³/h)
Filtro a sabbia
(Portata gruppo 10/8 m³/h)



EAN 13

	Ø	Height	Capacity	Weight	Box Dimensions	Flow Rate	Ladder	Barcode
KPE4527	Ø460 cm	120 cm	17.440 l	227/102 kg	1/120x80 1/90x80	8m ³ /h	√	8 4 12081 258966
KPE3527	Ø350 cm	120 cm	10.102 l	227/85 kg	1/120x80 1/90x80	8m ³ /h	√	8 4 12081 262635



MEDIDA PISCINA
POOL SIZE
DIMENSIONS PISCINE
MISURA PISCINA

ESPACIO NECESARIO
NECESSARY SPACE
ESPACE NECESSAIRE
SPAZIO NECESSARIO

KPE4527	Ø460x120 cm	Ø660x135 cm
KPE3527	Ø350x120 cm	Ø550x135 cm



Escalera:
3 peldaños - Inox.
Ladder:
3 steps - Stainless steel
Echelle:
3 marches - Acier inoxydable
Scala:
3 gradini - Inox



Manta protectora
(Poliéster)
Bottom protectiveblanket
(Polyester)
Tapis de sol en feutre
(Polyester)
Telo di protezione
(Poliestere)



Skimmer, manguera,
racordería...
Skimmer, hose,
fittings...
Skimmer, tuyau,
raccords...
Skimmer, tubi , kit
raccordi...





PISCINA DE PARED DE ACERO CON REVESTIMIENTO DE MADERA

LINER: Tratamiento Anti-ultravioleta que retrasa el envejecimiento del P.V.C.

CHAPA: Laminada en frío con tratamiento de galvanización, fosfatación e imprimación.

Perfilación vertical de la chapa para la obtención de una mayor resistencia.

Troquelada para skimmer y válvula de retorno del agua.

MADERA: Madera de pino nórdico, con tratamiento NIVEL IV CLASE V, según norma Europea EN-335. Troquelada para skimmer y válvula de retorno del agua.

PISCINE BOIS DOUBLE PAROI

LINER: Traitement anti-ultraviolets contre le vieillissement du P.V.C.

TÔLE: Tôle laminée à froid et traitée par galvanisation, phosphatage, couche d'apprêt et laquage.

Profilés verticaux pour une meilleure résistance.

Découpage pour le skimmer et la vanne anti-refoulement d'eau.

BOIS: Pin nordique, avec traitement de niveau IV, selon la norme Européenne; EN-335

STEEL WALL POOL WITH WOODEN COVERING

LINER: Anti-ultraviolet treatment to slow down P.V.C aging.

PLATE: Galvanized, phosphatized, primed and lacquered cold-rolled plate. Vertical sectioning for an increased strength.

Die cut for skimmer and water return valve openings.

WOOD: Nordic pine wood with level IV treatment according to EN-335 European Standard.

PISCINA CON RIVESTIMENTO IN LEGNO

LINER: Trattamento Anti-ultravioletti - Ritarda l'invecchiamento del P.V.C.

PANNELLO: Laminata a freddo con trattamento di galvanizzazione, fosfatazione e preparazione.

Preparazione verticale per ottenere una maggiore resistenza.

Stampigliatura per Skimmer e valvola di ritorno dell'acqua.

LEGNO: Legno di pino nordico, con trattamento livello iv classe v, secondo normativa Europea EN-335. Preparazione per skimmer e valvola di ritorno dell'acqua.



**MADE
IN
EU**

nature pool serie HAWAII



KITNPOV611



Sistema de omegas Omega system
Renforts enterrés Sistema omega

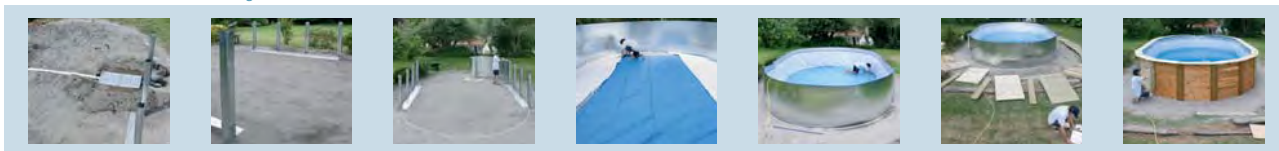

EAN 13

	750x425 cm	132 cm	28.050 l	497/498 kg	1/120x80 1/134x116	7m ³ /h	√	√	28	19,5/22	8 4 12081 227726
KITNPOV731											
KITNPOV611	640x425 cm	132 cm	23.230 l	411/421 kg	1/120x80 1/134x116	7m ³ /h	√	√	28	19,5/22	8 4 12081 227733



MEDIDA PISCINA
POOL SIZE
DIMENSIONS PISCINE
MISURA PISCINA

ESPACIO NECESARIO
NECESSARY SPACE
ESPACE NECESSAIRE
SPAZIO NECESSARIO

KITNPOV731	750x425 cm	800x450 cm
KITNPOV611	640x425 cm	700x450 cm



Liner PVC gresite
50/100
PVC gresite liner
50/100
Liner carrelage PVC
50/100
Liner PVC gresite
50/100

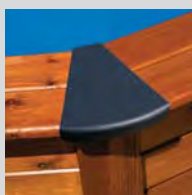

Tapas metal lacado
Perfilería de madera
Lacquered metal covers
Wooden frames
Cache-margelles métalliques
Poteaux et margelles en bois
Copertura metallica laccata
Bordi in legno

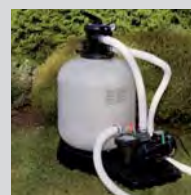

Depuradora arena
(Caudal grupo 7/5 m³/h)
Sand filter
(Flow group 7/5 m³/h)
Filtre à sable
(Débit groupe 7/5 m³/h)
Filtro a sabbia
Portata gruppo 7/5 m³/h



KITNP461

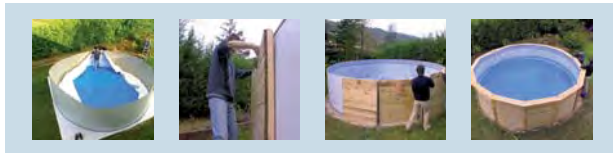

EAN 13

KITNP461	Ø500 cm	132 cm	20.270 l	217/385 kg	1/90x80 1/134x116	5m ³ /h	√	√	28	19,5	8 4 12081 227764
----------	---------	--------	----------	------------	----------------------	--------------------	---	---	----	------	------------------



KITNP461

MEDIDA PISCINA
POOL SIZE
DIMENSIONS PISCINE
MISURA PISCINA

Ø500 cm

ESPACIO NECESARIO
NECESSARY SPACE
ESPACE NECESSAIRE
SPAZIO NECESSARIO

510x510 cm



Tinte
Woodstainer
Lasure
Verniciatura



Escalera:
- Madera / acero inoxidable
Ladder:
- Bois / stainless steel
Échelle:
- Bois / acier inoxydable
Scale:
- Legno / acciaio inox

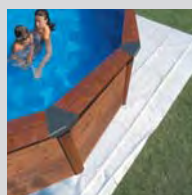

Manta protectora
(Poliéster)
Bottom protectiveblanket
(Polyester)
Tapis de sol en feutre
(Polyester)
Telo di protezione
(Poliestere)



Limpiafondos
automático
Automatic pool
cleaner
Aspirateur
automatique
Pulisci-fondo
automatico

nature pool serie ISLAND



KITNPOV612



Sistema de omegas Omega system Renforts enterrés Sistema omega

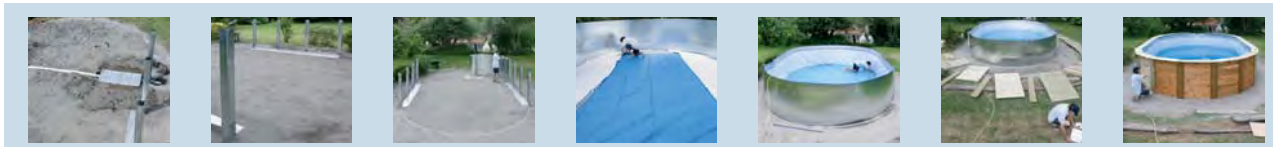

EAN 13

Model	Dimensions	Height	Volume	Weight	Capacity	Flow	Filter	Ladder	Steps	Weight	Price	Barcode
KITNPOV732	745x420 cm	120 cm	25.180 l	482/404 kg	1/90x80 1/124x116	5m³/h	√	√	24	19,5/22	8 412081 224923	
KITNPOV612	635x420 cm	120 cm	20.890 l	378/366 kg	1/90x80 1/124x116	4m³/h	√	√	24	19,5/22	8 412081 220093	
KITNPOV502	535x345 cm	120 cm	14.000 l	352/356 kg	1/90x80 1/124x116	3m³/h	√	√	24	14,5/22	8 412081 220109	



MEDIDA PISCINA
POOL SIZE
DIMENSIONS PISCINE
MISURA PISCINA

ESPACIO NECESARIO
NECESSARY SPACE
ESPACE NECESSAIRE
SPAZIO NECESSARIO

Model	Dimensions	Space
KITNPOV732	745x420 cm	800x450 cm
KITNPOV612	635x420 cm	700x450 cm
KITNPOV502	535x345 cm	600x375 cm



Liner PVC azul
40/100
PVC blue liner
40/100
Liner bleu
40/100
Liner blu
40/100

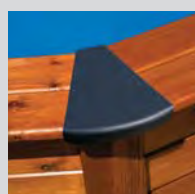

Tapas metal lacado
Periferia de madera
Lacquered metal covers
Wooden frames
Cache-margelles métalliques
Poteaux et margelles en bois
Copertura metallica laccata
Bordi in legno

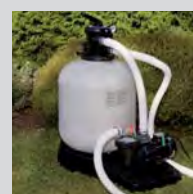

Depuradora arena
(Caudal grupo 5/4/3 m³/h)
Sand filter
(Flow group 5/4/3 m³/h)
Filtre à sable
(Débit groupe 5/4/3 m³/h)
Filtro a sabbia
(Portata gruppo 5/4/3 m³/h)



KITNP352

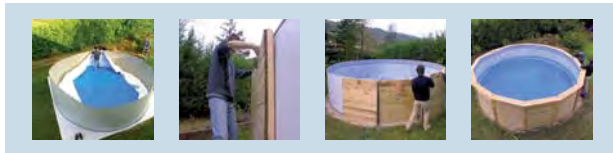

EAN 13

Model	Ø	Height	Capacity	Weight	Filter	Pump	Ladder	Filter	Material	Price	EAN 13
KITNP462	Ø490 cm	120 cm	17.450 l	199/337 kg	1/80x60 1/124x116	3m³/h	√	√	24	19,5	8 4 1 2 0 8 1 2 2 0 1 2 3
KITNP352A	Ø390 cm	120 cm	10.102 l	185/221 kg	1/80x60 1/124x116	3m³/h	√	√	24	14,5	8 4 1 2 0 8 1 2 2 4 9 3 0
KITNP242A	Ø280 cm	120 cm	4.750 l	159/219 kg	1/80x60 1/124x94,5	3m³/h	√	√	24	14,5	8 4 1 2 0 8 1 2 3 0 9 2 4



MEDIDA PISCINA
POOL SIZE
DIMENSIONS PISCINE
MISURA PISCINA

ESPACIO NECESARIO
NECESSARY SPACE
ESPACE NECESSAIRE
SPAZIO NECESSARIO

Model	Ø	Required Space
KITNP462	Ø490 cm	510x510 cm
KITNP352	Ø390 cm	410x410 cm
KITNP242	Ø280 cm	300x300 cm

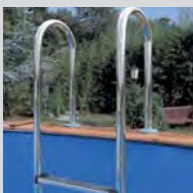

Escalera:
- Madera / acero inoxidable
Ladder:
- Bois / stainless steel
Échelle:
- Bois / acier inoxydable
Scale:
- Legno / acciaio inox

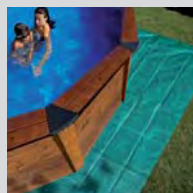

Tapiz protector
(Polietileno)
Floor tapestry
(Polythene)
Tapis de sol en feutre
(Polyéthylène)
Telo di protezione
(Polietilene)

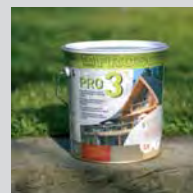

Tinte
Woodstainer
Lasure
Verniciatura

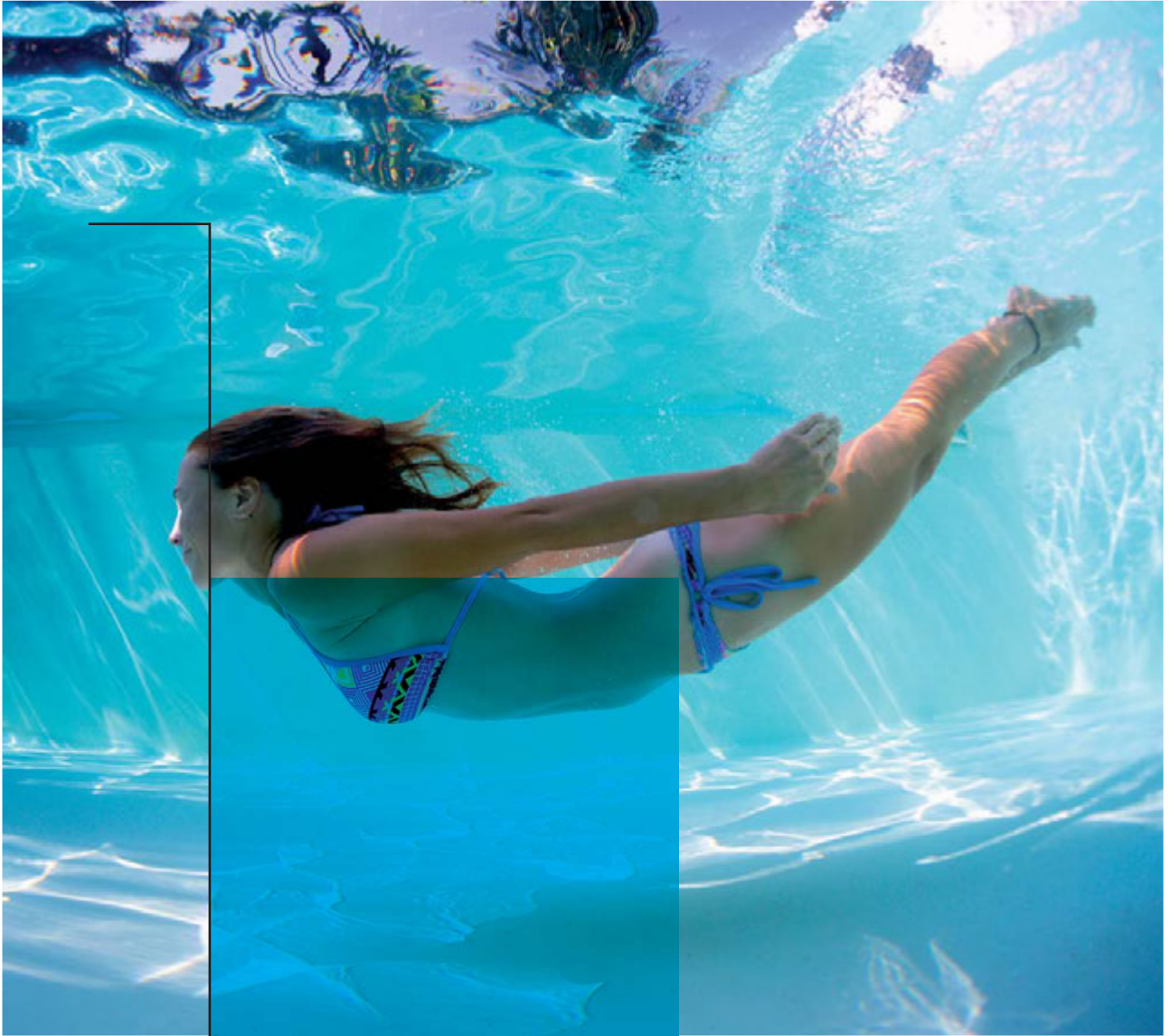

PISCINA DE PARED DE ACERO

LINER: Tratamiento Anti - Ultravioleta que retrasa el envejecimiento del P.V.C.

CHAPA: laminada en frío con tratamiento de galvanización, fosfatación, imprimación y lacado.

Perfilación vertical de la misma para la obtención de una mayor resistencia.

Troquelada para skimmer y válvula de retorno del agua.

PERFILES:: De acero y de P.V.C.

PISCINE PAROI ACIER

LINER: Traitement anti-ultraviolets contre le vieillissement du P.V.C.

TÔLE: Tôle laminée à froid et traitée par galvanisation, phosphatage, couche d'apprêt et laquage.

Profils verticaux pour une meilleure résistance.

Découpage pour le skimmer et la buse de refoulement.

STRUCTURE: Métalliques et P.V.C.

STEEL WALL POOL

LINER: Anti-ultraviolet treatment to slow down P.V.C aging.

PLATE: Galvanized, phosphatized, primed and lacquered cold-rolled plate .

Vertical sectioning for an increased strength . Die cut for skimmer and water return valve openings.

PROFILES: Steel or P.V.C

PISCINA CON PARETI IN ACCIAIO

LINER: Trattamento Anti-ultravioletti - Ritarda l'invecchiamento del P.V.C.

PANNELLO: Laminata a freddo con trattamento di galvanizzazione, fosfatazione e preparazione.

Preparazione verticale per ottenere una maggiore resistenza.

Stampigliatura per Skimmer e valvola di ritorno dell'acqua.

PROFILI: Acciaio e P.V.C.

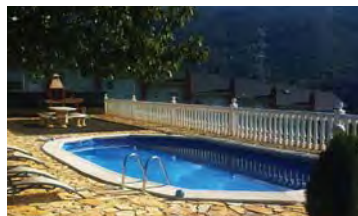

**MADE
IN
EU**

dream pool serie

CRETA



KITPROV7388NRT



EAN 13

Model	Dimensions (cm)	Depth (cm)	Volume (l)	Weight (kg)	Box Size	Flow Rate (m³/h)	Filter	Ladder	Cover	Liner	Barcode
KITPROV7388NRT	730x375	132	28.217 l	348 kg	1/120x80	5m³/h	√	√	15	12	8 412081 262086
KITPROV6188NRT	610x375	132	23.281 l	279 kg	1/90x80	5m³/h	√	√	15	12	8 412081 262093

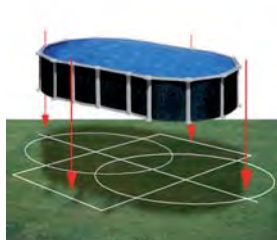

MEDIDA PISCINA
POOL SIZE
DIMENSIONS PISCINE
MISURA PISCINA

ESPACIO NECESARIO
NECESSARY SPACE
ESPACE NECESSAIRE
SPAZIO NECESSARIO

KITPROV7388NRT	730x375 cm	770x495 cm
KITPROV6188NRT	610x375 cm	650x495 cm



Liner PVC azul
40/100
PVC blue liner
40/100
Liner PVC bleu
40/100
Liner PVC blu
40/100



Protectores de
inyección
Injection saver
Protections moulées
par injection
Angolare di
protezione



Perfilería de acero
Steel profiles
Poteaux et margelles
acier
Profili in acciaio



Viga de acero enterrada de 15x15cm que hace innecesarios los postes exteriores, obteniendo mejor aprovechamiento del jardín.

15x15cm buried steel beam makes unnecessary the outer buttress, optimizing the use of the garden area.

Poteaux en acier à enterrer de 15x15 évitant des renforts apparents extérieurs, pour mieux profiter de l'espace du jardin.

Barra di acciaio interrata da 15x15 cm che non rende necessario l'utilizzo delle barre laterali; permette di poter sfruttare al meglio gli spazi del proprio giardino.



Sistema de omegas Omega system Renforts enterrés Sistema omega



Depuradora arena
(Caudal grupo 5 m³/h)
Sand filter
(Flow group 5 m³/h)
Filtre à sable
(Débit groupe 5 m³/h)
Filtro a sabbia
Portata gruppo 5 m³/h



Escalera de seguridad
Plataforma +2x3 Peldaños
Safety Ladder
Platform + 2x3 Steps
Échelle sécurité
Plateforme + 2x3 Marches
Scala di sicurezza
Piattaforma + 2x3 Gradini

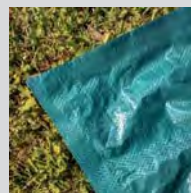

Tapiz protector
(Poliétileno)
Floor tapestry
(Polythene)
Tapis de sol en feutre
(Polyéthylène)
Telo di protezione
(Poliétilene)

dream pool serie RATTAN



KITPROV738NRT



EAN 13

Model	Dimensions (cm)	Height (cm)	Volume (l)	Weight (kg)	Box Size (cm)	Flow (m³/h)	✓	✓	15	12	Barcode
KITPROV738NRT	730x375	132	28.217 l	335	1/120x80	5m³/h	✓	✓	15	12	8 412081 257259
KITPROV618NRT	610x375	132	23.281 l	270	1/90x80	5m³/h	✓	✓	15	12	8 412081 257266
KITPROV508NRT	500x300	132	16.210 l	260	1/90x80	5m³/h	✓	✓	15	12	8 412081 258072



MEDIDA PISCINA
POOL SIZE
DIMENSIONS PISCINE
MISURA PISCINA

ESPACIO NECESARIO
NECESSARY SPACE
ESPACE NECESSAIRE
SPAZIO NECESSARIO

Model	Dimensions (cm)	Necessary Space (cm)
KITPROV738NRT	730x375	770x595
KITPROV618NRT	610x375	650x595
KITPROV508NRT	500x300	540x520



Liner PVC azul
40/100
PVC blue liner
40/100
Liner PVC bleu
40/100
Liner PVC blu
40/100



Protectores de
inyección
Injection saver
Protections moulées
par injection
Angolare di
protezione



Perfilería de acero
Steel profiles
Poteaux et margelles
acier
Profili in acciaio



KITPR558NRT



EAN 13

	Ø	Height	Volume	Weight	Box Size	Flow	✓	✓	Steps	Height	Depth	Barcode
KITPR558NRT	Ø550 cm	132 cm	27.798 l	243 kg	1/90x80	5m³/h	✓	✓	15	12	8 412081 257273	
KITPR458NRT	Ø460 cm	132 cm	19.444 l	238 kg	1/90x80	5m³/h	✓	✓	15	12	8 412081 257280	
KITPR358NRT	Ø350 cm	132 cm	11.250 l	184 kg	1/90x80	5m³/h	✓	✓	15	12	8 412081 257297	

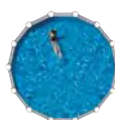

	MEDIDA PISCINA POOL SIZE DIMENSIONS PISCINE MISURA PISCINA	ESPACIO NECESARIO NECESSARY SPACE ESPACE NECESSAIRE SPAZIO NECESSARIO
KITPR558NRT	Ø 550cm	600x600 cm
KITPR458NRT	Ø 460cm	500x500 cm
KITPR358NRT	Ø 350cm	400x400 cm



Depuradora arena
(Caudal grupo 5 m³/h)
Sand filter
(Flow group 5 m³/h)
Filtre à sable
(Débit groupe 5 m³/h)
Filtro a sabbia
Portata gruppo 5 m³/h

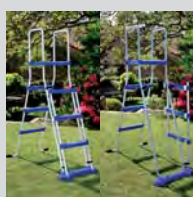

Escalera de seguridad
Plataforma +2x3 Peldaños
Safety Ladder
Platform + 2x3 Steps
Plateforme + 2x3 Marches
Échelle sécurité
Plateforme + 2x3 Marches
Scala di sicurezza
Piattaforma + 2x3 Gradini

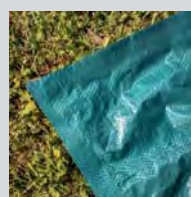

Tapiz protector
(Polietileno)
Floor tapestry
(Polythene)
Tapis de sol en feutre
(Polyéthylène)
Telo di protezione
(Polietilene)

dream pool serie

JAVA



KIT610NRT



EAN 13

	730x375 cm	610x375 cm	500x300 cm
KIT730NRT	730x375 cm	610x375 cm	500x300 cm
KIT610NRT	120 cm	120 cm	120 cm
KIT500NRT	25.323 l	20.893 l	14.550 l
	287 kg	235 kg	224 kg
	1/90x80	1/80x60	1/80x60
	4m ³ /h	3m ³ /h	3m ³ /h
	√	√	√
	15	15	15
	12	12	12
	8 4 1 2 0 8 1 2 5 7 6 6 2	8 4 1 2 0 8 1 2 5 7 6 5 5	8 4 1 2 0 8 1 2 5 7 6 4 8



MEDIDA PISCINA
POOL SIZE
DIMENSIONS PISCINE
MISURA PISCINA

ESPACIO NECESARIO
NECESSARY SPACE
ESPACE NECESSAIRE
SPAZIO NECESSARIO

KIT730NRT	730x375 cm	770x595 cm
KIT610NRT	610x375 cm	650x595 cm
KIT500NRT	500x300 cm	540x520 cm



Liner PVC azul 30/100
KIT730NRT/KIT610NRT: 40/100
PVC: blue liner 30/100
KIT730NRT/KIT610NRT: 40/100
Liner PVC bleu 30/100
KIT730NRT/KIT610NRT: 40/100
Liner PVC blu 30/100
KIT730NRT/KIT610NRT: 40/100

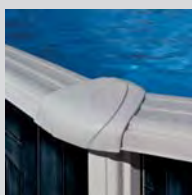

Protectores de inyección
Injection saver
Protections moulées par injection
Angolare di protezione



Perfilería de acero
Steel profiles
Poteaux et margelles acier
Profili in acciaio



KIT350NRT



EAN 13

KIT460NRT	Ø460 cm	120 cm	17.450 l	172 kg	1/80x60	3m ³ /h	√	15	12	
KIT350NRT	Ø350 cm	120 cm	10.102 l	146 kg	1/80x60	3m ³ /h	√	15	12	

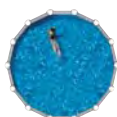

MEDIDA PISCINA
POOL SIZE
DIMENSIONS PISCINE
MISURA PISCINA

ESPACIO NECESARIO
NECESSARY SPACE
ESPACE NECESSAIRE
SPAZIO NECESSARIO

KIT460NRT	Ø 460cm	500x500 cm
KIT350NRT	Ø 350cm	400x400 cm



Depuradora arena
(Caudal grupo 3/4 m³/h)
Sand filter
(Flow group 3/4 m³/h)
Filtre à sable
(Débit groupe 3/4 m³/h)
Filtro a sabbia
Portata gruppo 3/4 m³/h

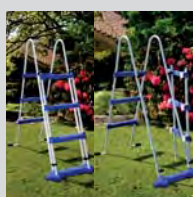

Escalera de seguridad
2x3 Peldaños
Safety Ladder
2x3 Steps
Échelle sécurité
2x3 Marches
Scala di sicurezza
2x3 Gradini

dream pool serie

SANTORINI



KITPROV7388PO



EAN 13

Model	Dimensions (cm)	Depth (cm)	Volume (l)	Weight (kg)	Box Size (cm)	Flow Rate (m³/h)	Filter	Ladder	Cap	Liner	Barcode
KITPROV7388PO	730x375	132	28.217	348	1/120x80	5m³/h	√	√	15	12	8 412081 264493
KITPROV6188PO	610x375	132	23.281	279	1/90x80	5m³/h	√	√	15	12	8 412081 264509



MEDIDA PISCINA
POOL SIZE
DIMENSIONS PISCINE
MISURA PISCINA

ESPACIO NECESARIO
NECESSARY SPACE
ESPACE NECESSAIRE
SPAZIO NECESSARIO

KITPROV7388P	730x375 cm	770x495 cm
KITPROV6188P	610x375 cm	650x495 cm



Liner PVC azul
40/100
PVC blue liner
40/100
Liner PVC bleu
40/100
Liner PVC blu
40/100



Protectores de
inyección
Injection saver
Protections moulées
par injection
Angolare di
protezione



Perfilería de acero
Steel profiles
Poteaux et margelles
acier
Profili in acciaio



Viga de acero enterrada de 15x15cm que hace innecesarios los postes exteriores, obteniendo mejor aprovechamiento del jardín.

15x15cm buried steel beam makes unnecessary the outer buttress, optimizing the use of the garden area.

Poteaux en acier à enterrer de 15x15 évitant des renforts apparents extérieurs, pour mieux profiter de l'espace du jardin.

Barra di acciaio interrata da 15x15 cm che non rende necessario l'utilizzo delle barre laterali; permette di poter sfruttare al meglio gli spazi del proprio giardino.

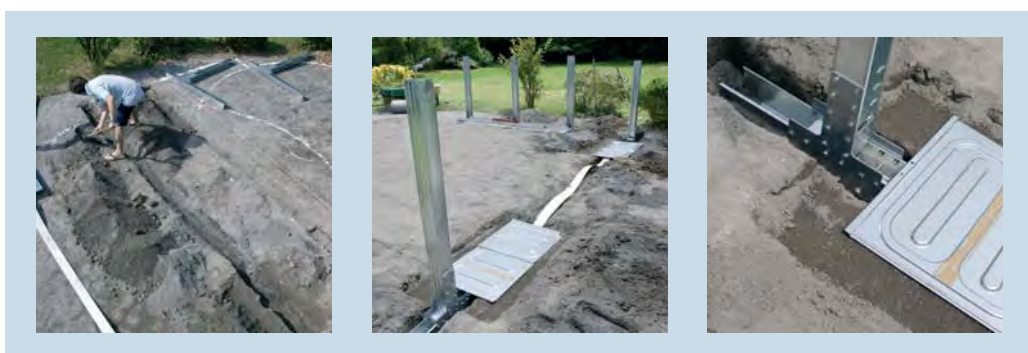

Sistema de omegas Omega system Renforts enterrés Sistema omega



Depuradora arena
(Caudal grupo 5 m³/h)
Sand filter
(Flow group 5 m³/h)
Filtre à sable
(Débit groupe 5 m³/h)
Filtro a sabbia
Portata gruppo 5 m³/h



Escalera de seguridad
Plataforma +2x3 Peldaños
Safety Ladder
Platform + 2x3 Steps
Échelle sécurité
Plateforme + 2x3 Marches
Scala di sicurezza
Piattaforma + 2x3 Gradini

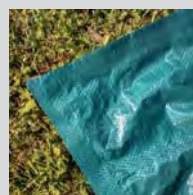

Tapiz protector
(Poliétileno)
Floor tapestry
(Polythene)
Tapis de sol en feutre
(Polyéthylène)
Telo di protezione
(Poliétilene)

dream pool serie

CÓRCEGA



KITPROV738PO



EAN 13

Model	Dimensions (cm)	Depth (cm)	Volume (l)	Weight (kg)	Box Size (cm)	Flow Rate (m³/h)	Filter	Ladder	Cover	Accessories	Barcode
KITPROV738PO	730x375	132	28.217	335	1/120x80	5m³/h	√	√	15	12	8 412081 264516
KITPROV618PO	610x375	132	23.281	270	1/90x80	5m³/h	√	√	15	12	8 412081 264523
KITPROV508PO	500x300	132	16.210	260	1/90x80	5m³/h	√	√	15	12	8 412081 264547

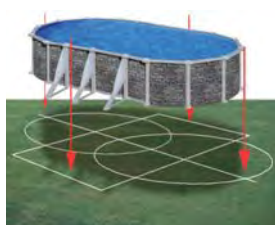

MEDIDA PISCINA
POOL SIZE
DIMENSIONS PISCINE
MISURA PISCINA

ESPACIO NECESARIO
NECESSARY SPACE
ESPACE NECESSAIRE
SPAZIO NECESSARIO

KITPROV738P	730x375 cm	770x595 cm
KITPROV618P	610x375 cm	650x595 cm
KITPROV508P	500x300 cm	540x520 cm



Liner PVC azul
40/100
PVC blue liner
40/100
Liner PVC bleu
40/100
Liner PVC blu
40/100



Protectores de
inyección
Injection saver
Protections moulées
par injection
Angolare di
protezione



Perfilería de acero
Steel profiles
Poteaux et margelles
acier
Profili in acciaio



KITPR558PO



EAN 13

KITPR558PO	Ø550 cm	132 cm	27.798 l	243 kg	1/90x80	5m³/h	√	√	15	12	
KITPR458PO	Ø460 cm	132 cm	19.444 l	238 kg	1/90x80	5m³/h	√	√	15	12	
KITPR358PO	Ø350 cm	132 cm	11.250 l	184 kg	1/90x80	5m³/h	√	√	15	12	



	MEDIDA PISCINA POOL SIZE DIMENSIONS PISCINE MISURA PISCINA	ESPACIO NECESARIO NECESSARY SPACE ESPACE NECESSAIRE SPAZIO NECESSARIO
KITPR558P	Ø 550cm	600x600 cm
KITPR458P	Ø 460cm	500x500 cm
KITPR358P	Ø 350cm	400x400 cm



Depuradora arena
(Caudal grupo 5 m³/h)
Sand filter
(Flow group 5 m³/h)
Filtre à sable
(Débit groupe 5 m³/h)
Filtro a sabbia
Portata gruppo 5 m³/h



Escalera de seguridad
Plataforma +2x3 Peldaños
Safety Ladder
Platform + 2x3 Steps
Plateforme + 2x3 Marches
Scala di sicurezza
Piattaforma + 2x3 Gradini

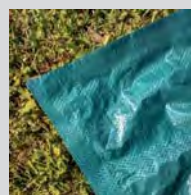

Tapiz protector
(Polietileno)
Floor tapestry
(Polythene)
Tapis de sol en feutre
(Polyéthylène)
Telo di protezione
(Polietilene)

dream pool serie CERDEÑA



KIT730PO



EAN 13

	730x375 cm	610x375 cm	500x300 cm
KIT730PO	730x375 cm	610x375 cm	500x300 cm
	120 cm	120 cm	120 cm
	25.323 l	20.893 l	14.550 l
	287 kg	235 kg	224 kg
	1/90x80	1/80x60	1/80x60
	4m ³ /h	3m ³ /h	3m ³ /h
	√	√	√
	15	15	15
	12	12	12
	8 4 1 2 0 8 1 2 6 4 5 7 8	8 4 1 2 0 8 1 2 6 4 5 8 5	8 4 1 2 0 8 1 2 6 4 5 9 2

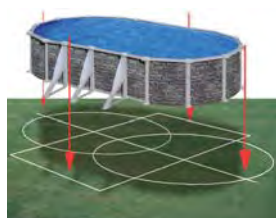

MEDIDA PISCINA
POOL SIZE
DIMENSIONS PISCINE
MISURA PISCINA

ESPACIO NECESARIO
NECESSARY SPACE
ESPACE NECESSAIRE
SPAZIO NECESSARIO

KIT730P	730x375 cm	770x595 cm
KIT610P	610x375 cm	650x595 cm
KIT500P	500x300 cm	540x520 cm



Liner PVC azul 30/100
KIT730P/KIT610P: 40/100
PVC blue liner 30/100
KIT730P/KIT610P: 40/100
Liner PVC bleu 30/100
KIT730P/KIT610P: 40/100
Liner PVC blu 30/100
KIT730P/KIT610P: 40/100

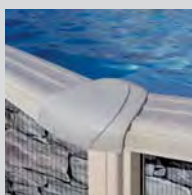

Protectores de inyección
Injection saver
Protections moulées par injection
Angolare di protezione

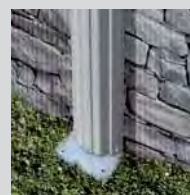

Perfilería de acero
Steel profiles
Poteaux et margelles acier
Profili in acciaio



KIT460PO



EAN 13

	Ø	cm	l	kg	cm	m ³ /h	√	cm	cm	Barcode
KIT460PO	Ø460	120	17.450	172	1/80x60	3m ³ /h	√	15	12	8 412081 264608
KIT350PO	Ø350	120	10.102	146	1/80x60	3m ³ /h	√	15	12	8 412081 264615
KIT240PO	Ø240	120	4.750	126	1/80x60	3m ³ /h	√	15	12	8 412081 264622

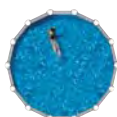

MEDIDA PISCINA
POOL SIZE
DIMENSIONS PISCINE
MISURA PISCINA

ESPACIO NECESARIO
NECESSARY SPACE
ESPACE NECESSAIRE
SPAZIO NECESSARIO

KIT460P	Ø 460cm	500x500 cm
KIT350P	Ø 350cm	400x400 cm
KIT240P	Ø 240cm	300x300 cm



Depuradora arena
(Caudal grupo 3/4 m³/h)
Sand filter
(Flow group 3/4 m³/h)
Filtre à sable
(Débit groupe 3/4 m³/h)
Filtro a sabbia
Portata gruppo 3/4 m³/h

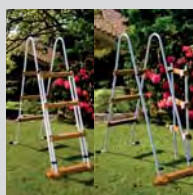

Escalera de seguridad
2x3 Peldaños
Safety Ladder
2x3 Steps
Échelle sécurité
2x3 Marches
Scala di sicurezza
2x3 Gradini

dream pool serie

AMAZONIA



KITPROV7388WO



EAN 13

KITPROV7388WO	730x375 cm	132 cm	28.217 l	348 kg	1/120x80	5m ³ /h	√	√	15	12	
KITPROV6188WO	610x375 cm	132 cm	23.281 l	279 kg	1/90x80	5m ³ /h	√	√	15	12	



MEDIDA PISCINA
POOL SIZE
DIMENSIONS PISCINE
MISURA PISCINA

ESPACIO NECESARIO
NECESSARY SPACE
ESPACE NECESSAIRE
SPAZIO NECESSARIO

KITPROV7388WO	730x375 cm	770x495 cm
KITPROV6188WO	610x375 cm	650x495 cm



Liner PVC azul
40/100
PVC blue liner
40/100
Liner PVC bleu
40/100
Liner PVC blu
40/100

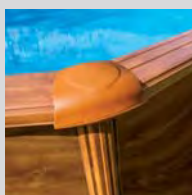

Protectores de
inyección
Injection saver
Protections moulées
par injection
Angolare di
protezione

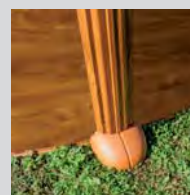

Perfilería de acero
Steel profiles
Poteaux et margelles
acier
Profili in acciaio



Viga de acero enterrada de 15x15cm que hace innecesarios los postes exteriores, obteniendo mejor aprovechamiento del jardín.

15x15cm buried steel beam makes unnecessary the outer buttress, optimizing the use of the garden area.

Poteaux en acier à enterrer de 15x15 évitant des renforts apparents extérieurs, pour mieux profiter de l'espace du jardin.

Barra di acciaio interrata da 15x15 cm che non rende necessario l'utilizzo delle barre laterali; permette di poter sfruttare al meglio gli spazi del proprio giardino.



Sistema de omegas Omega system Renforts enterrés Sistema omega



Depuradora arena
(Caudal grupo 5 m³/h)
Sand filter
(Flow group 5 m³/h)
Filtre à sable
(Débit groupe 5 m³/h)
Filtro a sabbia
Portata gruppo 5 m³/h



Escalera de seguridad
Plataforma +2x3 Peldaños
Safety Ladder
Platform + 2x3 Steps
Échelle sécurité
Plateforme + 2x3 Marches
Scala di sicurezza
Piattaforma + 2x3 Gradini

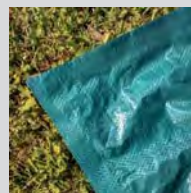

Tapiz protector
(Poliétileno)
Floor tapestry
(Polythene)
Tapis de sol en feutre
(Polyéthylène)
Telo di protezione
(Poliétilene)

dream pool serie

MAURITIUS



KITPROV738WO



EAN 13

Model	Dimensions (LxW)	Height	Volume	Weight	Filter	Flow Rate	Accessories	Steps	Cover	Accessories	EAN 13
KITPROV738WO	730x375 cm	132 cm	28.217 l	335 kg	1/120x80	5m³/h	√	√	15	12	8 412081 257358
KITPROV618WO	610x375 cm	132 cm	23.281 l	270 kg	1/90x80	5m³/h	√	√	15	12	8 412081 257365
KITPROV508WO	500x300 cm	132 cm	16.210 l	260 kg	1/90x80	5m³/h	√	√	15	12	8 412081 258089



MEDIDA PISCINA
POOL SIZE
DIMENSIONS PISCINE
MISURA PISCINA

ESPACIO NECESARIO
NECESSARY SPACE
ESPACE NECESSAIRE
SPAZIO NECESSARIO

KITPROV738WO	730x375 cm	770x595 cm
KITPROV618WO	610x375 cm	650x595 cm
KITPROV508WO	500x300 cm	540x520 cm



Liner PVC azul
40/100
PVC blue liner
40/100
Liner PVC bleu
40/100
Liner PVC blu
40/100

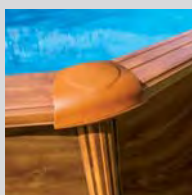

Protectores de
inyección
Injection saver
Protections moulées
par injection
Angolare di
protezione

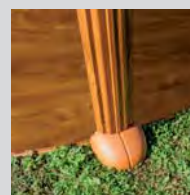

Perfilería de acero
Steel profiles
Poteaux et margelles
acier
Profili in acciaio



KITPR558WO



EAN 13

	Ø	h	V	P	Paquete	Filtración	Escalera	Cubierta	Tapiz	Altura	Barcode
KITPR558WO	Ø550 cm	132 cm	27.798 l	243 kg	1/90x80	5m³/h	✓	✓	15	12	8 412081 257372
KITPR458WO	Ø460 cm	132 cm	19.444 l	238 kg	1/90x80	5m³/h	✓	✓	15	12	8 412081 257389
KITPR358WO	Ø350 cm	132 cm	11.250 l	184 kg	1/90x80	5m³/h	✓	✓	15	12	8 412081 257396



	MEDIDA PISCINA POOL SIZE DIMENSIONS PISCINE MISURA PISCINA	ESPACIO NECESARIO NECESSARY SPACE ESPACE NECESSAIRE SPAZIO NECESSARIO
KITPR558WO	Ø 550cm	600x600 cm
KITPR458WO	Ø 460cm	500x500 cm
KITPR358WO	Ø 350cm	400x400 cm

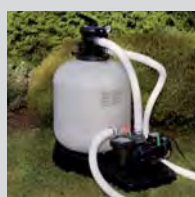

Depuradora arena
(Caudal grupo 5 m³/h)
Sand filter
(Flow group 5 m³/h)
Filtre à sable
(Débit groupe 5 m³/h)
Filtro a sabbia
Portata gruppo 5 m³/h



Escalera de seguridad
Plataforma +2x3 Peldaños
Safety Ladder
Platform + 2x3 Steps
Plateforme + 2x3 Marches
Échelle sécurité
Plateforme + 2x3 Marches
Scala di sicurezza
Piattaforma + 2x3 Gradini

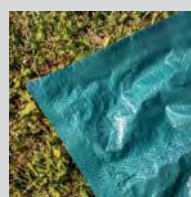

Tapiz protector
(Polietileno)
Floor tapestry
(Polythene)
Tapis de sol en feutre
(Polyéthylène)
Telo di protezione
(Polietilene)

dream pool serie **MALDIVAS**



KITPROV5083W



EAN 13

KITPROV5083W

500x300 cm

132 cm

16.210 l

217 kg

1/90x80

3,8m³/h

√

15

12



MEDIDA PISCINA
POOL SIZE
DIMENSIONS PISCINE
MISURA PISCINA

ESPACIO NECESARIO
NECESSARY SPACE
ESPACE NECESSAIRE
SPAZIO NECESSARIO

KITPROV5083W

500x300 cm

540x520 cm



Liner PVC azul
40/100
PVC blue liner
40/100
Liner PVC bleu
40/100
Liner PVC blu
40/100

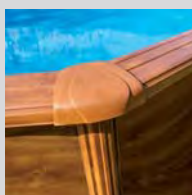

Protectores de
inyección
Injection saver
Protections moulées
par injection
Angolare di
protezione

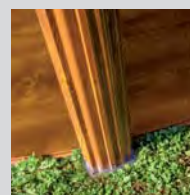

Perfilería de acero
Steel profiles
Poteaux et margelles
acier
Profili in acciaio



KITPR4583W



EAN 13

	Ø	Height	Capacity	Weight	Box Size	Flow Rate	✓	Platform	Steps	Barcode
KITPR4583W	Ø460 cm	132 cm	19.444 l	167 kg	1/80x40	3,8m³/h	✓	15	12	8 4 1 2 0 8 1 2 5 8 0 5 8
KITPR3583W	Ø350 cm	132 cm	11.250 l	156 kg	1/80x40	3,8m³/h	✓	15	12	8 4 1 2 0 8 1 2 5 8 0 6 5



MEDIDA PISCINA
POOL SIZE
DIMENSIONS PISCINE
MISURA PISCINA

ESPACIO NECESARIO
NECESSARY SPACE
ESPACE NECESSAIRE
SPAZIO NECESSARIO

KITPR4583W	Ø 460cm	500x500 cm
KITPR3583W	Ø 350cm	400x400 cm

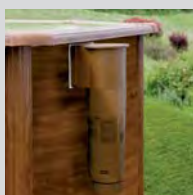

Filtro de cartucho
(3,8 m³/h)
Cartidge filter
(3,8 m³/h)
Filtre à cartouche
(3,8 m³/h)
Filtro a cartuccia
(3,8 m³/h)



Escalera de seguridad
Plataforma +2x3 Peldaños
Safety Ladder
Platform + 2x3 Steps
Échelle sécurité
Plateforme + 2x3 Marches
Scala di sicurezza
Piattaforma + 2x3 Gradini

dream pool serie PACIFIC



KIT730W



EAN 13

Model	Dimensions (cm)	Height (cm)	Capacity (l)	Weight (kg)	Box Size (cm)	Flow Rate (m³/h)	Accessories	Height (cm)	Depth (cm)	Barcode
KIT730W	730x375	120	25.323	287	1/90x80	4m³/h	√	15	12	8 412081 232249
KIT610W	610x375	120	20.893	235	1/80x60	3m³/h	√	15	12	8 412081 225104
KIT500W	500x300	120	14.550	224	1/80x60	3m³/h	√	15	12	8 412081 231068



MEDIDA PISCINA
POOL SIZE
DIMENSIONS PISCINE
MISURA PISCINA

ESPACIO NECESARIO
NECESSARY SPACE
ESPACE NECESSAIRE
SPAZIO NECESSARIO

Model	Dimensions (cm)	Necessary Space (cm)
KIT730W	730x375	770x595
KIT610W	610x375	650x595
KIT500W	500x300	540x520



Liner PVC azul 30/100
KIT730W/KIT610W: 40/100
PVC blue liner 30/100
KIT730W/KIT610W: 40/100
Liner PVC bleu 30/100
KIT730W/KIT610W: 40/100
Liner PVC blu 30/100
KIT730W/KIT610W: 40/100

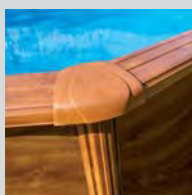

Protectores de inyección
Injection saver
Protections moulées par injection
Angolare di protezione

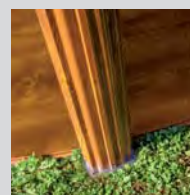

Perfilería de acero
Steel profiles
Poteaux et margelles acier
Profili in acciaio



KIT460W



EAN 13

	Ø	h	V	P	Paquete	Flujo	✓	P	H	Barcode
KIT460W	Ø460 cm	120 cm	17.450 l	172 kg	1/80x60	3m³/h	✓	15	12	8 4 12081 225111
KIT350W	Ø350 cm	120 cm	10.102 l	146 kg	1/80x60	3m³/h	✓	15	12	8 4 12081 225722
KIT240W	Ø240 cm	120 cm	4.750 l	126 kg	1/80x60	3m³/h	✓	15	12	8 4 12081 226163

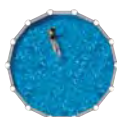

MEDIDA PISCINA
POOL SIZE
DIMENSIONS PISCINE
MISURA PISCINA

ESPACIO NECESARIO
NECESSARY SPACE
ESPACE NECESSAIRE
SPAZIO NECESSARIO

	MEDIDA PISCINA	ESPACIO NECESARIO
KIT460W	Ø 460cm	500x500 cm
KIT350W	Ø 350cm	400x400 cm
KIT240W	Ø 240cm	300x300 cm

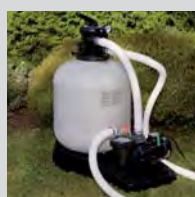

Depuradora arena
(Caudal grupo 3/4 m³/h)
Sand filter
(Flow group 3/4 m³/h)
Filtre à sable
(Débit groupe 3/4 m³/h)
Filtro a sabbia
Portata gruppo 3/4 m³/h

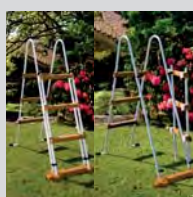

Escalera de seguridad
2x3 Peldaños
Safety Ladder
2x3 Steps
Echelle sécurité
2x3 Marches
Scala di sicurezza
2x3 Gradini

dream pool serie

SICILIA



KITPROV503W



EAN 13

KITPROV503W

500x300 cm

120 cm

14.550 l

205 kg

1/80x60

3,8m³/h

√

15

12



MEDIDA PISCINA
POOL SIZE
DIMENSIONS PISCINE
MISURA PISCINA

ESPACIO NECESARIO
NECESSARY SPACE
ESPACE NECESSAIRE
SPAZIO NECESSARIO

KITPROV503W

500x300 cm

540x520 cm



Liner PVC azul
30/100
PVC blue liner
30/100
Liner PVC bleu
30/100
Liner PVC blu
30/100

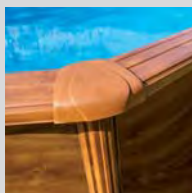

Protectores de
inyección
Injection saver
Protections moulées
par injection
Angolare di
protezione

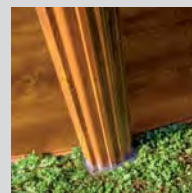

Perfilería de acero
Steel profiles
Poteaux et margelles
acier
Profili in acciaio



KITPR453W



EAN 13

	Ø	h	V	P	C	Q	✓	L	L	Barcode
KITPR453W	Ø460 cm	120 cm	17.450 l	149 kg	3/120x80	3,8m³/h	✓	15	12	8 412081 258171
KITPR353W	Ø350 cm	120 cm	10.102 l	109 kg	3/120x80	3,8m³/h	✓	15	12	8 412081 258188
KITPR303W	Ø300 cm	120 cm	7.418 l	94 kg	3/120x80	3,8m³/h	✓	15	12	8 412081 265087



MEDIDA PISCINA
POOL SIZE
DIMENSIONS PISCINE
MISURA PISCINA

ESPACIO NECESARIO
NECESSARY SPACE
ESPACE NECESSAIRE
SPAZIO NECESSARIO

KITPR453W	Ø 460cm	500x500 cm
KITPR353W	Ø 350cm	400x400 cm
KITPR303W	Ø 300cm	350x350 cm



Filtro de cartucho
(3,8 m³/h)
Cartidge filter
(3,8 m³/h)
Filtre à cartouche
(3,8 m³/h)
Filtro a cartuccia
(3,8 m³/h)

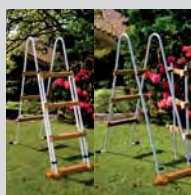

Escalera de seguridad
2x3 Peldaños
Safety Ladder
2x3 Steps
Échelle sécurité
2x3 Marches
Scala di sicurezza
2x3 Gradini

dream pool serie

HAITI



KITPROV9188



EAN 13

Model	Dimensions (cm)	Height (cm)	Capacity (l)	Weight (kg)	Box Size (cm)	Flow Rate (m³/h)	Feature 1	Feature 2	Feature 3	Feature 4	Feature 5	Barcode
KITPROV10288	1000x550	132	56.111	620	1/120x100	10	✓	✓	15	12	8 412081 224626	
KITPROV9188	915x470	132	43.595	602	1/120x80	8	✓	✓	15	12	8 412081 220215	
KITPROV8188	800x470	132	37.474	482	1/120x80	7	✓	✓	15	12	8 412081 224633	
KITPROV7388	730x375	132	28.217	348	1/120x80	5	✓	✓	15	12	8 412081 220222	
KITPROV6188	610x375	132	23.281	279	1/90x80	5	✓	✓	15	12	8 412081 221328	



Model	MEDIDA PISCINA POOL SIZE DIMENSIONS PISCINE MISURA PISCINA	ESPACIO NECESARIO NECESSARY SPACE ESPACE NECESSAIRE SPAZIO NECESSARIO
KITPROV10288	1000x550 cm	1040x670 cm
KITPROV9188	915x470 cm	955x590 cm
KITPROV8188	800x470 cm	850x590 cm
KITPROV7388	730x375 cm	770x495 cm
KITPROV6188	610x375 cm	650x495 cm



Liner PVC azul 40/100
PVC blue liner 40/100
Liner PVC bleu 40/100
Liner PVC blu 40/100



Protectores de inyección
Injection saver
Protections moulées par injection
Angolare di protezione



Perfilería de acero
Steel profiles
Poteaux et margelles acier
Profili in acciaio



Viga de acero enterrada de 15x15cm que hace innecesarios los postes exteriores, obteniendo mejor aprovechamiento del jardín.

15x15cm buried steel beam makes unnecessary the outer buttress, optimizing the use of the garden area.

Poteaux en acier à enterrer de 15x15 évitant des renforts apparents extérieurs, pour mieux profiter de l'espace du jardin.

Barra di acciaio interrata da 15x15 cm che non rende necessario l'utilizzo delle barre laterali; permette di poter sfruttare al meglio gli spazi del proprio giardino.



Sistema de omegas Omega system Renforts enterrés Sistema omega



Depuradora arena
(Caudal grupo 10/8/7/5 m³/h)
Sand filter
(Flow group 10/8/7/5 m³/h)
Filtre à sable
(Débit groupe 10/8/7/5 m³/h)
Filtro a sabbia
Portata gruppo 10/8/7/5 m³/h



Escalera de seguridad
Plataforma +2x3 Peldaños
Safety Ladder
Platform + 2x3 Steps
Échelle sécurité
Plateforme + 2x3 Marches
Scala di sicurezza
Piattaforma + 2x3 Gradini

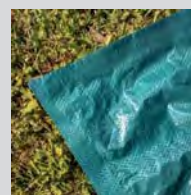

Tapiz protector
(Polietileno)
Floor tapestry
(Polythene)
Tapis de sol en feutre
(Polyéthylène)
Telo di protezione
(Polietilene)

dream pool serie

ATLANTIS



KITPROV918



EAN 13

KITPROV1028	1000x550 cm	132 cm	56.111 l	620 kg	1/120x100	10m³/h	√	√	15	12	
KITPROV918	915x470 cm	132 cm	43.595 l	602 kg	1/120x80	8m³/h	√	√	15	12	
KITPROV818	800x470 cm	132 cm	37.474 l	482 kg	1/120x80	7m³/h	√	√	15	12	
KITPROV738	730x375 cm	132 cm	28.217 l	348 kg	1/120x80	5m³/h	√	√	15	12	
KITPROV618	610x375 cm	132 cm	23.281 l	279 kg	1/90x80	5m³/h	√	√	15	12	
KITPROV508	500x300 cm	132 cm	16.210 l	260 kg	1/90x80	5m³/h	√	√	15	12	

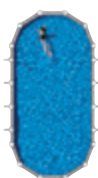

MEDIDA PISCINA
POOL SIZE
DIMENSIONS PISCINE
MISURA PISCINA

ESPACIO NECESARIO
NECESSARY SPACE
ESPACE NECESSAIRE
SPAZIO NECESSARIO

KITPROV1028	1000x550 cm	1040x770 cm
KITPROV918	915x470 cm	955x690 cm
KITPROV818	800x470 cm	850x690 cm
KITPROV738	730x375 cm	770x595 cm
KITPROV618	610x375 cm	650x595 cm
KITPROV508	500x300 cm	540x520 cm



Liner PVC azul
40/100
PVC blue liner
40/100
Liner PVC bleu
40/100
Liner PVC blu
40/100



Protectores de
inyección
Injection saver
Protections moulées
par injection
Angolare di
protezione



Perfilería de acero
Steel profiles
Poteaux et margelles
acier
Profili in acciaio



KITPR558



EAN 13

Model	Ø	Height	Capacity (l)	Weight (kg)	Box Dimensions	Flow Rate (m³/h)	Filter	Ladder	Mat	Accessories	Barcode
KITPR558	Ø550 cm	132 cm	27.798 l	243 kg	1/90x80	5m³/h	✓	✓	15	12	8 412081 211589
KITPR458	Ø460 cm	132 cm	19.444 l	238 kg	1/90x80	5m³/h	✓	✓	15	12	8 412081 211596
KITPR358	Ø350 cm	132 cm	11.250 l	184 kg	1/90x80	5m³/h	✓	✓	15	12	8 412081 233864

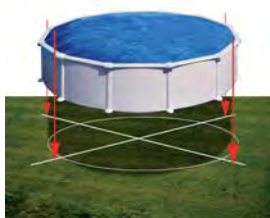

	MEDIDA PISCINA POOL SIZE DIMENSIONS PISCINE MISURA PISCINA	ESPACIO NECESARIO NECESSARY SPACE ESPACE NECESSAIRE SPAZIO NECESSARIO
KITPR558	Ø 550cm	600x600 cm
KITPR458	Ø 460cm	500x500 cm
KITPR358	Ø 350cm	400x400 cm

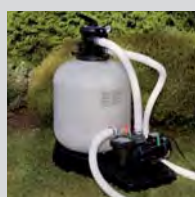

Depuradora arena
(Caudal grupo 10/8/7/5 m³/h)
Sand filter
(Flow group 10/8/7/5 m³/h)
Filtre à sable
(Débit groupe 10/8/7/5 m³/h)
Filtro a sabbia
Portata gruppo 10/8/7/5 m³/h



Escalera de seguridad
Plataforma +2x3 Peldaños
Safety Ladder
Platform + 2x3 Steps
Plateforme + 2x3 Marches
Échelle sécurité
Plateforme + 2x3 Marches
Scala di sicurezza
Piattaforma + 2x3 Gradini

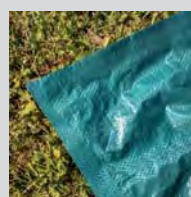

Tapiz protector
(Polietileno)
Floor tapestry
(Polythene)
Tapis de sol en feutre
(Polyéthylène)
Telo di protezione
(Polietilene)

dream pool serie **AZORES**



KITPROV5083

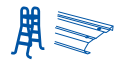

EAN 13

KITPROV5083

500x300 cm

132 cm

16.210 l

217 kg

1/90x80

3,8m³/h

√

15

12

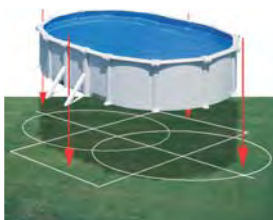

MEDIDA PISCINA
POOL SIZE
DIMENSIONS PISCINE
MISURA PISCINA

ESPACIO NECESARIO
NECESSARY SPACE
ESPACE NECESSAIRE
SPAZIO NECESSARIO

KITPROV5083

500x300 cm

540x520 cm



Liner PVC azul
40/100
PVC blue liner
40/100
Liner PVC bleu
40/100
Liner PVC blu
40/100



Protectores de
inyección
Injection saver
Protections moulées
par injection
Angolare di
protezione

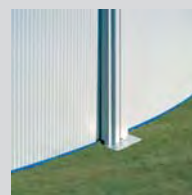

Perfilería de acero
Steel profiles
Poteaux et margelles
acier
Profili in acciaio



KITPR4583



EAN 13

	Ø	Height	Capacity	Weight	Box Size	Flow Rate	✓	Platform	Steps	Barcode
KITPR4583	Ø460 cm	132 cm	19.444 l	167 kg	1/80x40	3,8m³/h	✓	15	12	8 4 1 2 0 8 1 2 5 8 0 2 7
KITPR3583	Ø350 cm	132 cm	11.250 l	156 kg	1/80x40	3,8m³/h	✓	15	12	8 4 1 2 0 8 1 2 5 8 0 3 4

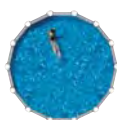
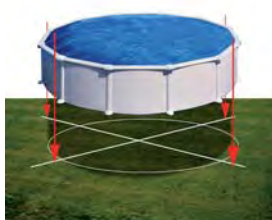

	MEDIDA PISCINA POOL SIZE DIMENSIONS PISCINE MISURA PISCINA	ESPACIO NECESARIO NECESSARY SPACE ESPACE NECESSAIRE SPAZIO NECESSARIO
KITPR4583	Ø 460cm	500x500 cm
KITPR3583	Ø 350cm	400x400 cm



Filtro de cartucho
(3,8 m³/h)
Cartidge filter
(3,8 m³/h)
Filtre à cartouche
(3,8 m³/h)
Filtro a cartuccia
(3,8 m³/h)

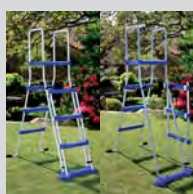

Escalera de seguridad
Plataforma +2x3 Peldaños
Safety Ladder
Platform + 2x3 Steps
Échelle sécurité
Plateforme + 2x3 Marches
Scala di sicurezza
Piattaforma + 2x3 Gradini

dream pool serie FIDJI



KIT730ECO



EAN 13

Model	Dimensions (cm)	Height (cm)	Capacity (l)	Weight (kg)	Box Size (cm)	Flow Rate (m³/h)	Accessories	Ladder	Accessories	Accessories	Barcode
KIT730ECO	730x375	120	25.323	287	1/90x80	4m³/h	√	15	12	8 4 12081 2 11398	
KIT610ECO	610x375	120	20.893	235	1/80x60	3m³/h	√	15	12	8 4 12081 2 11404	
KIT500ECO	500x300	120	14.550	224	1/80x60	3m³/h	√	15	12	8 4 12081 2 31037	

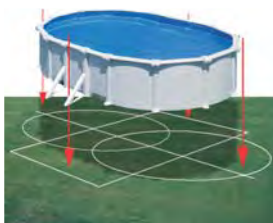

MEDIDA PISCINA
POOL SIZE
DIMENSIONS PISCINE
MISURA PISCINA

ESPACIO NECESARIO
NECESSARY SPACE
ESPACE NECESSAIRE
SPAZIO NECESSARIO

Model	Pool Size (cm)	Necessary Space (cm)
KIT730ECO	730x375	770x595
KIT610ECO	610x375	650x595
KIT500ECO	500x300	540x520



Liner PVC azul 30/100
KIT730/KIT610: 40/100
PVC blue liner 30/100
KIT730/KIT610: 40/100
Liner PVC bleu 30/100
KIT730/KIT610: 40/100
Liner PVC blu 30/100
KIT730/KIT610: 40/100



Protectores de inyección
Injection saver
Inyección savers
Protections moulées par injection
Angolare di protezione

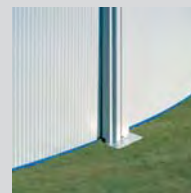

Perfilería de acero
Steel profiles
Poteaux et margelles acier
Profili in acciaio



KIT350ECO



EAN 13

Model	Pool Diameter	Pool Height	Volume	Weight	Box Size	Flow Rate	Filter	Steps	Accessories	Barcode
KIT550ECO	Ø550 cm	120 cm	24.944 l	209 kg	1/80x60	4m³/h	√	15	12	8 4 120 81 2 114 11
KIT460ECO	Ø460 cm	120 cm	17.450 l	172 kg	1/80x60	3m³/h	√	15	12	8 4 120 81 2 114 28
KIT350ECO	Ø350 cm	120 cm	10.102 l	146 kg	1/80x60	3m³/h	√	15	12	8 4 120 81 2 114 35
KIT300ECO	Ø300 cm	120 cm	7.418 l	136 kg	1/80x60	3m³/h	√	15	12	8 4 120 81 2 287 54
KIT240ECO	Ø240 cm	120 cm	4.750 l	120 kg	1/80x60	3m³/h	√	15	12	8 4 120 81 2 408 31



MEDIDA PISCINA
POOL SIZE
DIMENSIONS PISCINE
MISURA PISCINA

ESPACIO NECESARIO
NECESSARY SPACE
ESPACE NECESSAIRE
SPAZIO NECESSARIO

Model	Pool Diameter	Necessary Space
KIT550ECO	Ø 550cm	600x600 cm
KIT460ECO	Ø 460cm	500x500 cm
KIT350ECO	Ø 350cm	400x400 cm
KIT300ECO	Ø 300cm	350x350 cm
KIT240ECO	Ø 240cm	300x300 cm



Depuradora arena
(Caudal grupo 3/4 m³/h)
Sand filter
(Flow group 3/4 m³/h)
Filtre à sable
(Débit groupe 3/4 m³/h)
Filtro a sabbia
Portata gruppo 3/4 m³/h

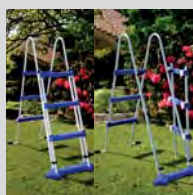

Escalera de seguridad
2x3 Peldaños
Safety Ladder
2x3 Steps
Echelle sécurité
2x3 Marches
Scala di sicurezza
2x3 Gradini

dream pool serie

VARADERO



KITPROV7070



EAN 13

	Dimensions	Depth	Volume	Weight	Box Size	Pump	Ladder	Accessories	Height	Length	Barcode
KITPROV7070	710x475 cm	120 cm	27.872 l	371 kg	1/90x80	4m³/h	✓	✓	15	12	8 412081 211626
KITPROV6270	640x390 cm	120 cm	20.652 l	311 kg	1/90x80	4m³/h	✓	✓	15	12	8 412081 211633
KITPROV4870	500x340 cm	120 cm	13.696 l	284 kg	1/90x80	4m³/h	✓	✓	15	12	8 412081 231921



MEDIDA PISCINA
POOL SIZE
DIMENSIONS PISCINE
MISURA PISCINA

ESPACIO NECESARIO
NECESSARY SPACE
ESPACE NECESSAIRE
SPAZIO NECESSARIO

KITPROV7070	710x475 cm	755x510 cm
KITPROV6270	640x390 cm	700x430 cm
KITPROV4870	500x340 cm	540x380 cm



Liner PVC azul
40/100
PVC blue liner
40/100
Liner PVC bleu
40/100
Liner PVC blu
40/100



Protectores de
inyección
Injection saver
Protections moulées
par injection
Angolare di
protezione

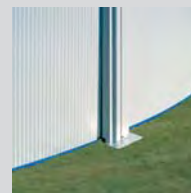

Perfilería de acero
Steel profiles
Poteaux et margelles
acier
Profili in acciaio



Viga de acero enterrada de 15x15cm que hace innecesarios los postes exteriores, obteniendo mejor aprovechamiento del jardín.

15x15cm buried steel beam makes unnecessary the outer buttress, optimizing the use of the garden area.

Poteaux en acier à enterrer de 15x15 évitant des renforts apparents extérieurs, pour mieux profiter de l'espace du jardin.

Barra di acciaio interrata da 15x15 cm che non rende necessario l'utilizzo delle barre laterali; permette di poter sfruttare al meglio gli spazi del proprio giardino.

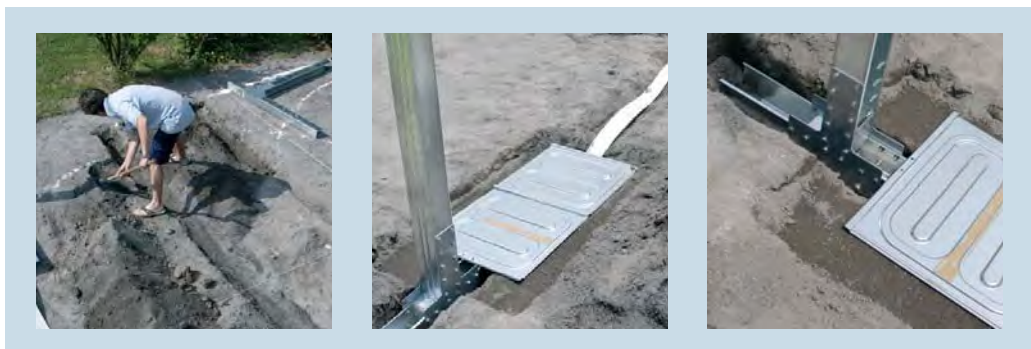

Sistema de omegas Omega system Renforts enterrés Sistema omega



Depuradora arena
(Caudal grupo 4 m³/h)
Sand filter
(Flow group 4 m³/h)
Filtre à sable
(Débit groupe 4 m³/h)
Filtro a sabbia
Portata gruppo 4 m³/h

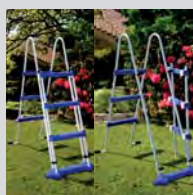

Escalera de seguridad
2x3 Peldaños
Safety Ladder
2x3 Steps
Échelle sécurité
2x3 Marches
Scala di sicurezza
2x3 Gradini

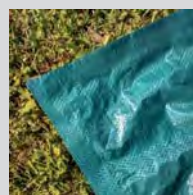

Tapiz protector
(Polietileno)
Floor tapestry
(Polythene)
Tapis de sol en feutre
(Polyéthylène)
Telo di protezione
(Polietilene)

dream pool serie

BORA BORA



KITPROV613



EAN 13

	610x375 cm	120 cm	20.893 l	210 kg	1/80x60	3,8m ³ /h	√	15	12	8 412081 220437
KITPROV613	610x375 cm	120 cm	20.893 l	210 kg	1/80x60	3,8m ³ /h	√	15	12	8 412081 220437
KITPROV503	500x300 cm	120 cm	14.550 l	205 kg	1/80x60	3,8m ³ /h	√	15	12	8 412081 220260

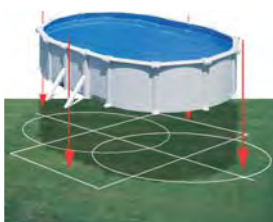

MEDIDA PISCINA
POOL SIZE
DIMENSIONS PISCINE
MISURA PISCINA

ESPACIO NECESARIO
NECESSARY SPACE
ESPACE NECESSAIRE
SPAZIO NECESSARIO

KITPROV613	610x375 cm	650x595 cm
KITPROV503	500x300 cm	540x520 cm



Liner PVC azul 30/100
KITPROV613: 40/100
PVC blue liner 30/100
KITPROV613: 40/100
Liner PVC bleu 30/100
KITPROV613: 40/100
Liner PVC blu 30/100
KITPROV613: 40/100



Protectores de inyección
Injection saver
Protections moulées par injection
Angolare di protezione



Perfilería de acero
Steel profiles
Poteaux et margelles acier
Profili in acciaio



KITPR453



EAN 13

Model	Pool Diameter	Pool Depth	Volume	Weight	Box Dimensions	Flow Rate	Filter	Ladder	Steps	Barcode
KITPR453	Ø460 cm	120 cm	17.450 l	149 kg	1/80x40	3,8m³/h	√	15	12	8 412081 209005
KITPR353	Ø350 cm	120 cm	10.102 l	109 kg	1/80x40	3,8m³/h	√	15	12	8 412081 209012
KITPR303	Ø300 cm	120 cm	7.418 l	94 kg	1/80x40	3,8m³/h	√	15	12	8 412081 233901

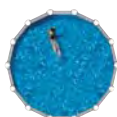
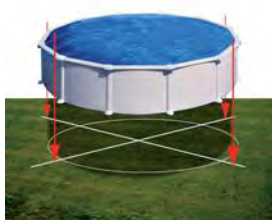

MEDIDA PISCINA
POOL SIZE
DIMENSIONS PISCINE
MISURA PISCINA

ESPACIO NECESARIO
NECESSARY SPACE
ESPACE NECESSAIRE
SPAZIO NECESSARIO

Model	Pool Diameter	Necessary Space
KITPR453	Ø 460cm	500x500 cm
KITPR353	Ø 350cm	400x400 cm
KITPR303	Ø 300cm	350x350 cm



Filtro de cartucho
(3,8 m³/h)
Cartidge filter
(3,8 m³/h)
Filtre à cartouche
(3,8 m³/h)
Filtro a cartuccia
(3,8 m³/h)

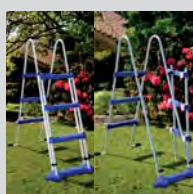

Escalera de seguridad
2x3 Peldaños
Safety Ladder
2x3 Steps
Échelle sécurité
2x3 Marches
Scala di sicurezza
2x3 Gradini

dream pool serie

LANZAROTE

KITWPR452E



EAN 13

	Ø	cm	l	kg	8/120x80	2m³/h	√	3,5	3,5	8 412081 241418
KITWPR452E	Ø450	90	12.717	56	8/120x80	2m³/h	√	3,5	3,5	8 412081 241418
KITWPR352E	Ø350	90	7.693	47	8/120x80	2m³/h	√	3,5	3,5	8 412081 241401
KITWPR302	Ø300	90	6.358	44	8/120x80	2m³/h	√	3,5	3,5	8 412081 231044

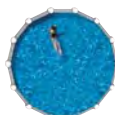
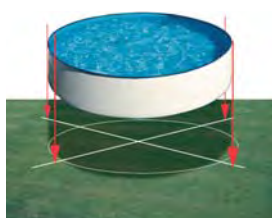

MEDIDA PISCINA
POOL SIZE
DIMENSIONS PISCINE
MISURA PISCINA

ESPACIO NECESARIO
NECESSARY SPACE
ESPACE NECESSAIRE
SPAZIO NECESSARIO

KITWPR452E	Ø 460cm	500x500 cm
KITWPR352E	Ø 350cm	400x400 cm
KITWPR302	Ø 300cm	350x350 cm



Liner PVC azul
20/100
PVC blue liner
20/100
Liner PVC bleu
20/100
Liner PVC blu
40/100



Filtro de cartucho:
2 m³/h
Cartidge filter
2 m³/h
Filtre à cartouche
2 m³/h
Filtro a cartuccia
2 m³/h



Escalera
2x2 Peldaños
Ladder
2x2 Steps
Échelle
2x2 Marches
Scala
2x2 Gradini

dream pool serie **TENERIFE**



KITWPR450E



EAN 13

KITWPR450E	Ø450 cm	90 cm	12.717 l	56 kg	8/120x80	2m³/h	√	3,5	3,5	
KITWPR350E	Ø350 cm	90 cm	7.693 l	47 kg	8/120x80	2m³/h	√	3,5	3,5	

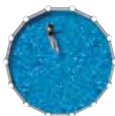
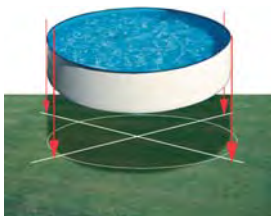

	MEDIDA PISCINA POOL SIZE DIMENSIONS PISCINE MISURA PISCINA	ESPACIO NECESARIO NECESSARY SPACE ESPACE NECESSAIRE SPAZIO NECESSARIO
KITWPR450E	Ø 460cm	500x500 cm
KITWPR350E	Ø 350cm	400x400 cm

jet pool

serie

JUNIOR



PISCINAS DE TUBO DE ACERO

LINER: Lámina de P.V.C. de alta resistencia. Soldadura por alta frecuencia. Con desagüe.

ESTRUCTURA: Metálica pintada en epoxy-poliéster atóxico - para mayor resistencia a la corrosión. Patas soldadas al codo que evitan la rotura. Bases de P.V.C. que mejoran la estabilidad de la piscina.

STEEL FRAME POOL

LINER: high resistance PVC plate. High-frequency welding. Drain included.

STRUCTURE: Non toxic epoxy-polyester paint for higher corrosion resistance. Legs welded to elbow bends to prevent breaks. P.V.C. bottomed legs for increased pool stability.

PISCINE TUBES EN ACIER

LINER: Liner P.V.C. À haute résistance. Soudure par haute fréquence. Système d'évacuation.

STRUCTURE: Métallique peinte en époxy-poliéster non toxique, pour une meilleure Résistance à la corrosion pattes soudées au coude, pour éviter la cassure. Bases en pvc pour améliorer la stabilité de la piscine.

PISCINE IN TUBI D'ACCIAIO

LINER: Lamina di P.V.C. ad alta resistenza. Saldatura ad alta frequenza. Con scarico.

STRUTTURA: Metallica dipinta in epoxi-poliestere per una maggiore resistenza alla corrosione. Struttura superiore saldata nelle giunture per evitare la rottura. Basi in P.V.C. che migliorano la stabilità della piscina.

WET230



EAN 13

	Ø 215 cm	45 cm	1.215 l	8,5 kg	60/120x80	√	8 412081 920238
WET230	Ø 215 cm	45 cm	1.215 l	8,5 kg	60/120x80	√	8 412081 920238
WET200	190x190 cm	45 cm	1.450 l	10,3 kg	60/120x80	√	8 412081 920221
Y25	125x125 cm	35 cm	500 l	5,7 kg	60/120x80	√	8 412081 870199

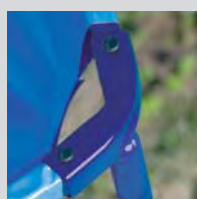
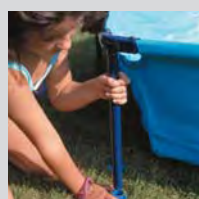

Estructura tubular
Desagüe
Tubular structure
Drain
Structure tubulaire
Système d'évacuation
Struttura tubolare
Scarico



Leyenda Legend Légende Legenda

BX

caja
box
box
scatola

BXL

caja con etiqueta
box and label
carton avec étiquette
scatola con etichetta

CB

cartoncillo
cardboard wrap
bande carton
cartone

CBX

caja litografiada
colour box
boîte de couleur
scatola serigrafata

PB

bolsa de plástico
polybag
sac plastique
busta di plastica

PBH

bolsa de plástico con cartoncillo
polybag with header
sac plastique avec bande carton
sacchetto di plastica con cartone

BL

blister
blister
blister
blister

CS

doble burbuja
clamshell
double coque
doppio rivestimento

DIS

display
display
display
display

complementos complements

COMPLEMENTOS	58	COMPLEMENTS
Cubiertas isotérmicas	60	Isothermic covers
Cubiertas de invierno	61	Winter covers
Mantas	62	Bottom protective blankets
Liners	64	Liners
Enrolladores de cubiertas	66	Telescopic cover rollers
Escaleras para piscinas enterradas	67	Inground pool ladders
Escaleras para piscinas sobre suelo	68	Above-ground pool ladders
Monoblocs de filtración	70	Filtration kit
Cargas filtrantes	72	Filter media
Skimmers	72	Skimmers
Filtros de Cartucho	73	Cartridge filter
Cartuchos	73	Cartridges
Tratamiento de agua	74	Water treatment
Electrolisis de sal	74	Electrolysis of salt
Sistemas de dosificación	77	Dosing systems
Local técnico	77	Technical room
Bombas	78	Pumps
Iluminación	79	Lighting
Calefacción	82	Heating systems
Calefacción solar	83	Solar heating system
Duchas	84	Showers
Repuestos	88	Spare parts

complements complementi

COMPLEMENTS	58	COMPLEMENTI
Couvertures isothermes	60	Copertura isotermitica
Couvertures pour l'hiver	61	Copertura invernale
Couvertures de protection du fond	62	Telo di protezione fondi
Liners	64	Liners
Enrouleurs de bâches	66	Avvolgitore
Échelles pour piscines enterrées	67	Scaletta per piscina interrata
Échelles pour piscines hors sol	68	Scaletta per piscina fuori terra
Platine de filtration	70	Filtro monoblocco
Médias filtrants	72	Carico filtrante
Skimmers	72	Skimmers
Epurateur a cartouche	73	Filtri a cartuccia
Cartouches	73	Cartucce
Traitement d'eau	74	Trattamento acqua
Electrolyse de sel	74	Elettrolisi salina
Systemes de dosage	77	Sistemi di dosaggio
Local technique	77	Locale tecnico
Pompes	78	Pompe
Éclairage	79	Illuminazione
Chauffage	82	Riscaldamento
Chauffage solaire	83	Riscaldamento solare
Douches	84	Docce
Pièces de rechange	88	Ricambi accessori

CUBIERTAS ISOTÉRMICAS ISOTHERMIC COVERS COUVERTURES ISOTHERMES COPERTURE ISOTHERMICHE



Material: Polietileno Matériel: Polyéthylène
Material: Polythene Materiale: Polietilene

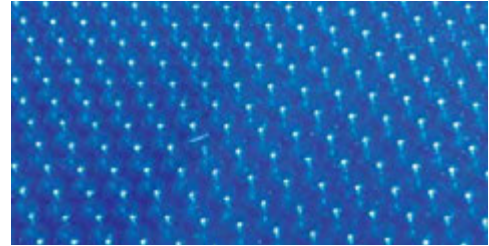

EAN 13

CPROV1020	995x545	180 μ	-	1000x550	-	-	-	PBH pack 1	8 4 1 2 0 8 1 2 2 0 5 3 6
CPROV915	910x460	180 μ	-	915x470	-	-	-	PBH pack 1	8 4 1 2 0 8 1 9 8 0 3 2 4
CPROV810	805x460	180 μ	-	810x470	-	-	-	PBH pack 1	8 4 1 2 0 8 1 2 0 5 9 8 4
CPROV730	725x370	180 μ	-	730x375	-	-	-	PBH pack 1	8 4 1 2 0 8 1 9 8 0 3 3 1
CPROV610	605x370	180 μ	-	610x375	-	-	-	PBH pack 1	8 4 1 2 0 8 1 2 0 5 9 9 1
CPROV505	495x295	180 μ	-	500x300	-	-	-	PBH pack 1	8 4 1 2 0 8 1 2 2 1 8 2 3
CPROV700	672x445	180 μ	-	-	710x475	-	-	PBH pack 1	8 4 1 2 0 8 1 2 0 5 8 3 0
CPROV600	620x370	180 μ	-	-	640x390	-	-	PBH pack 1	8 4 1 2 0 8 1 2 0 5 8 4 7
CPROV500	472x305	180 μ	-	-	500x340	-	-	PBH pack 1	8 4 1 2 0 8 1 2 0 5 8 5 4
CPR650	640 ø	180 μ	-	-	-	ø 640	-	PBH pack 1	8 4 1 2 0 8 1 9 5 0 3 0 3
CPR550	545 ø	180 μ	-	-	-	ø 550	-	PBH pack 1	8 4 1 2 0 8 1 9 4 0 6 0 1
CV450	455 ø	180 μ	ø 550	-	-	ø 460	ø 450	PBH pack 1	8 4 1 2 0 8 1 2 0 2 5 2 5
						ø 460			
CPR400	395 ø	180 μ	-	-	-	-	ø 400	PBH pack 1	8 4 1 2 0 8 1 9 4 0 6 2 5
CV350	345 ø	180 μ	ø 450	-	-	ø 350	ø 350	PBH pack 1	8 4 1 2 0 8 1 2 0 2 5 3 2
CV300	295 ø	180 μ	ø 350	-	-	ø 300	ø 300	PBH pack 1	8 4 1 2 0 8 1 2 0 2 5 4 9
CV250	245 ø	180 μ	ø 300	-	-	ø 240	-	PBH pack 1	8 4 1 2 0 8 1 2 0 8 5 6 5

CUBIERTAS DE INVIERNO WINTER COVERS
COUVERTURES POUR L'HIVER COPERTURA INVERNALE



Material: Polietileno Matériel: Polyéthylène
 Material: Polythene Materiale: Polietilene



EAN 13

CIPROV1001	1115x660	100 g/m ²	-	-	1000x550	-	-	-	CBX pack 3	8 4 1 2 0 8 1 2 2 1 8 5 4
CIPROV911	1030x560	100 g/m ²	-	-	915x470	-	-	-	CBX pack 3	8 4 1 2 0 8 1 2 0 8 6 7 1
CIPROV821	930x560	100 g/m ²	-	-	800x470	710x475	-	-	CBX pack 3	8 4 1 2 0 8 1 2 0 8 6 8 8
CIPROV731	820x460	100 g/m ²	-	-	730x375	640x390	-	-	CBX pack 3	8 4 1 2 0 8 1 2 0 8 6 9 5
CIPROV611	680x460	100 g/m ²	-	-	610x375	500x340	-	-	CBX pack 3	8 4 1 2 0 8 1 2 0 8 7 0 1
CIPROV501	610x410	100 g/m ²	-	-	500x300	-	-	-	CBX pack 3	8 4 1 2 0 8 1 2 2 1 8 6 1
CIPR651	730 ø	100 g/m ²	-	-	-	-	ø 640	-	CBX pack 3	8 4 1 2 0 8 1 2 0 8 7 1 8
CIPR551	640 ø	100 g/m ²	-	-	-	-	ø 550	-	CBX pack 5	8 4 1 2 0 8 1 2 0 8 7 2 5
CIPR451	540 ø	100 g/m ²	-	ø 550	-	-	ø 460	ø 450 ø 460	CBX pack 5	8 4 1 2 0 8 1 2 0 8 7 3 2
CIPR401	480 ø	100 g/m ²	ø 440	ø 450	-	-	-	ø 400	CBX pack 5	8 4 1 2 0 8 1 2 0 8 7 4 9
CIPR351	440 ø	100 g/m ²	ø 360	ø 350 ø 360	-	-	ø 350	ø 350	CBX pack 5	8 4 1 2 0 8 1 2 0 8 7 5 6
CIPR301	380 ø	100 g/m ²	-	-	-	-	ø 300	-	CBX pack 5	8 4 1 2 0 8 1 2 2 0 5 6 7
CIPR241	330 ø	100 g/m ²	-	-	-	-	ø 240	-	CBX pack 5	8 4 1 2 0 8 1 2 2 0 5 7 4

MANTAS PROCTORAS BOTTOM PROTECTIVE BLANKET POUR LE SOL DES PISCINES COUVERTURES DE PROTECTION DU FOND TAPPETO DI PROTEZIONE



Material: Poliéster
Material: Polyester
Matériel: Polyester
Materiale: Poliestere



EAN 13

MPROV1100	1100x600	110 g/m ²	-	-	-	1000x550	-	-	-	PBH pack 1	 8 4 12081 214528
MPROV915	950x500	110 g/m ²	-	-	-	915x470	-	-	-	PBH pack 1	 8 4 12081 980256
MPROV810	825x500	110 g/m ²	780x400	-	780x400	810x470	710x475	-	-	PBH pack 1	 8 4 12081 206004
MPROV730	750x400	110 g/m ²	660x280	-	660x280	730x375	640x390	-	-	PBH pack 1	 8 4 12081 980263
MPROV610	625x400	110 g/m ²	530x280	-	530x280	610x375	500x340	-	-	PBH pack 1	 8 4 12081 206011
MPROV500	525x325	110 g/m ²	-	-	-	500x300	-	-	-	PBH pack 1	 8 4 12081 231075
MPR650	650x650	110 g/m ²	-	-	-	-	-	ø 640	-	PBH pack 1	 8 4 12081 960111
MPR550	550x550	110 g/m ²	-	-	ø 550	-	-	ø 550	-	PBH pack 1	 8 4 12081 960128
MPR450	550x500	110 g/m ²	-	ø 440	ø 450	-	-	ø 460 ø 450	ø 460	PBH pack 1	 8 4 12081 960135
MPR400	400x400	110 g/m ²	-	ø 360	-	-	-	ø 350	ø 400	PBH pack 1	 8 4 12081 960142
MPR350	500x500	110 g/m ²	-	-	ø 350	-	-	ø 350 ø 300	ø 350	PBH pack 1	 8 4 12081 960159
MPR250	250x250	110 g/m ²	-	-	ø 240	-	-	ø 240	-	PBH pack 1	 8 4 12081 208572



POOL HOUSE

REF. PH54

BXL PACK 1

5x4,33x2,50 m



TOLDO PISCINA

Dimensiones: 5,00 x 4,33 x 2,50 m

Material: Poliéster

Paneles laterales de PVC transparente

3 puertas con cierre de cremallera

AUVENT DE PROTECTION

Dimensions : 5,00 x 4,33 x 2,50 m

Matériau : Polyester

Parois latérales en PVC transparent

3 portes avec fermeture éclair

POOL HOUSE

Assembled size: 5,00 x 4,33 x 2,5m

Material: Polyester. Transparent PVC side

walls. 3 doors with zipper close. Adaptable to 4m pools.

GAZEBO DI PROTEZIONE

Dimensioni: 5,00 x 4,33 x 2,50 m

Materiale: Poliestere

Pannelli laterali in PVC trasparente

3 porte con chiusura a zip



FLOOR PROTECTOR

REF. MPF509

CBX PACK 14

50x50cmx4,5mm



PROTECTOR DE SUELO DE PISCINA

Polietileno duradero

Ofrece una protección adicional para el fondo de la piscina

Contiene 9 piezas de 50x50cm

POOL FLOOR PROTECTOR

Durable Polyethylene

Provides added protection for pool floors

Package contains 9 pieces of 50x50cm

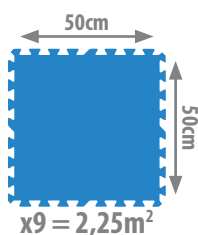

PROTECTEUR DE SOL DE PISCINE

Polyéthylène résistant

Fournit une protection supplémentaire pour les sols de piscines

L'emballage contient 9 pièces 50x50cm

PROTEZIONE PER IL FONDO DELLA PISCINA

In polietilene resistente

Evita che il fondo della piscina si danneggi

Il package include 9 pezzi, 50x50cm

LINERS LINERS FONDS LINERS



Liner azul (AZ)
Blue liner (AZ)
Liner bleu (AZ)
Liner blu (AZ)



Liner gresite (GR)
Ceramics liner (GR)
Liner carrelage (GR)
Liner mosaicato (GR)



EAN 13

Code	Material	Type	Width	Length	Quantity	EAN 13
FPR557	GR	SC	Ø 550	132cm	50/100	8 412081 258249
FPR457	GR	SC	Ø 460	132cm	50/100	8 412081 258256
FPR357	GR	SC	Ø 350	132cm	50/100	8 412081 258263
FPR558	AZ	SC	Ø 550	132cm	40/100	8 412081 214504
FPR458	AZ	SC	Ø 460	132cm	40/100	8 412081 224121
FPR358	AZ	SC	Ø 350	132cm	40/100	8 412081 233918
FPR551	AZ	SC	Ø 550	120cm	40/100	8 412081 950648
FPR451	AZ	SC	Ø 460	120cm	40/100	8 412081 980485
FPR352	AZ	SC	Ø 350	120cm	40/100	8 412081 200576
FPR301	AZ	SC	Ø 300	120cm	40/100	8 412081 216027
FPR241	AZ	SC	Ø 240	120cm	40/100	8 412081 203010
FPR354	AZ	SC	Ø 350	90cm	30/100	8 412081 201177
FSP450	AZ	OV	Ø 450	90cm	20/100	8 412081 990217
FSP400	AZ	OV	Ø 400	90cm	20/100	8 412081 990224
FSP350	AZ	OV	Ø 350	90cm	20/100	8 412081 990231
FSP300	AZ	OV	Ø 300	90cm	20/100	8 412081 203249
FWPR30	AZ	OV	Ø 300	65cm	20/100	8 412081 201191



Sistema colgante (SC)
Hanging system (SC)
Rail d'accroche (SC)
Con barra di aggancio (SC)



Sistema overlap (OV)
Overlap system (OV)
Système à recouvrement (OV)
Sistema overlap (OV)



EAN 13

FPROV917	GR	SC	915x470	132cm	50/100	8 4 1 2 0 8 1 2 5 8 1 9 5 1
FPROV827	GR	SC	800x470	132cm	50/100	8 4 1 2 0 8 1 2 5 8 2 0 1
FPROV737	GR	SC	730x375	132cm	50/100	8 4 1 2 0 8 1 2 5 8 2 1 8
FPROV617	GR	SC	610x375	132cm	50/100	8 4 1 2 0 8 1 2 5 8 2 2 5
FPROV517	GR	SC	500x300	132cm	50/100	8 4 1 2 0 8 1 2 5 8 2 3 2
FPROV1028	AZ	SC	1000x550	132cm	40/100	8 4 1 2 0 8 1 2 2 4 1 6 9
FPROV918	AZ	SC	915x470	132cm	40/100	8 4 1 2 0 8 1 2 1 4 5 1 1
FPROV818	AZ	SC	800x470	132cm	40/100	8 4 1 2 0 8 1 2 2 4 0 9 1
FPROV738	AZ	SC	730x375	132cm	40/100	8 4 1 2 0 8 1 2 2 4 1 0 7
FPROV618	AZ	SC	610x375	132cm	40/100	8 4 1 2 0 8 1 2 2 4 1 1 4
FPROV915	AZ	SC	915x470	120cm	40/100	8 4 1 2 0 8 1 9 8 0 2 7 0
FPROV810	AZ	SC	800x470	120cm	40/100	8 4 1 2 0 8 1 2 0 6 0 5 9
FPROV730	AZ	SC	730x375	120cm	40/100	8 4 1 2 0 8 1 9 8 0 2 8 7
FPROV610	AZ	SC	610x375	120cm	40/100	8 4 1 2 0 8 1 2 0 6 0 6 6
FPROV500	AZ	SC	500x300	120cm	40/100	8 4 1 2 0 8 1 2 2 1 8 7 8



EAN 13

FPROV707	AZ	SC	700x450	120cm	40/100	8 4 1 2 0 8 1 2 0 4 3 3 8
FPROV627	AZ	SC	625x375	120cm	40/100	8 4 1 2 0 8 1 2 0 4 3 4 5
FPROV507	AZ	SC	500x310	120cm	40/100	8 4 1 2 0 8 1 2 0 4 3 5 2

ENROLLADORES DE CUBIERTAS TELESCOPIC COVER ROLLERS ENROULEURS DE BÂCHES AVVOGLITORE PER PISCINE



REF. 90171

CBX PACK 1



Enrollador piscinas enterradas

Enrollador de cubierta para piscinas enterradas. Ofrece un desarrollo máximo de 5,50m. Ideal para piscinas redondas, cuadradas u ovaladas. Contiene tubos redondos en aluminio anodizado, un volante ergonómico con empuñadura giratoria así como un kit para atar la cubierta.

Cover roller for inground pools

Winder cover for in ground pools. Unfolds to a maximum length of 5.50 m. Suitable for round, square or oval swimming pools. Includes round anodised aluminium tubes, an ergonomic hand wheel with revolving handle as well as a kit to attach it to the cover.

Enrouleur pour piscines hors-sol

Enrouleur de bâche pour piscines enterrées. Il offre un développement maximum de 5,50m. Il convient aux piscines rondes, carrées ou ovales. Il est équipé de tubes ronds en aluminium anodisés, d'un volant ergonomique avec poignée tournante et d'un kit d'attache pour bâche. Cet enrouleur est livré en un seul colis, packaging couleur.

Avvolgitore per piscina interrate

Avvolgitore "grandi ruote" per piscina interrate. Si srotola fino a un massimo di 5.50m. Adatto per le piscine tonde, quadrate e ovali. Contiene un tubo in alluminio anodizzato, una ghiera ergonomica con una impugnatura rotatoria e un kit per fissare la copertura. Consegnato in un unico imballo.



REF. 40135

CBX PACK 2



Enrollador piscinas elevadas

El Enrollador ofrece un desarrollo máximo de 6,5m. Se ata fácilmente a las "playas" de la piscina con 2 placas atornilladas. El uso del enrollador permite una mejor conservación de la cubierta. Incluido: Conectores para piscinas tubulares.

Cover roller for above-ground pools

The Winder unfolds to a maximum length of 6.5 m. It can be easily attached to the "edge" finishing pieces of the pool using 2 bolted plates. The use of the winder enables a better conservation of the cover. Included: Connectors for tubular pools.

Enrouleur pour piscines hors-sol

Enrouleur offrant un développement maximum de 6,5m. Il se fixe facilement sur les 2 margelles de la piscine grâce à ses 2 plaques vissées. L'utilisation de l'enrouleur permet de conserver la bâche dans de bonnes conditions. Inclus: Connecteurs pour piscines tubulaires.

Avvolgitore per piscina fuoriterra

Avvolgitore che si srotola fino a un massimo di 6.5 m. Si fissa facilmente alla "bordo" della piscina con 2 placche con viti. L'utilizzo dell'avvolgitore permette una migliore conservazione della copertura.

ESCALERAS PARA PISCINA ENTERRADA INGROUND POOL LADDERS
ÉCHELLES POUR PISCINES ENTERRÉES SCALETTA PER PISCINA INTERRATA



STANDARD

REF. 40272A **BXL PACK 1**



Escalera STANDARD para piscina enterrada de 4 peldaños Inox.
 Échelle modèle STANDARD acier inoxydable pour piscine enterrée - 4 marches

Stainless steel STANDARD inground pool ladder - 4 steps.
 Scaletta STANDARD per piscina interrata da 4 gradini – Inox

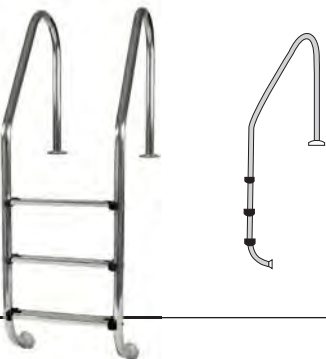

STANDARD

REF. 40110 **BXL PACK 1**



Escalera STANDARD para piscina enterrada de 3 peldaños Inox.
 Échelle modèle STANDARD acier inoxydable pour piscine enterrée - 3 marches

Stainless steel STANDARD inground pool ladder - 3 steps.
 Scaletta STANDARD per piscina interrata da 3 gradini – Inox

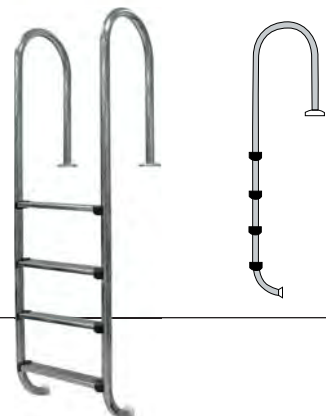

WALL

REF. 40274 **BXL PACK 1**



Escalera MURO para piscina enterrada de 4 peldaños – Inox
 Échelle MURALE acier inoxydable pour piscine enterrée - 4 marches

Stainless steel inground pool WALL ladder - 4 steps
 Scaletta MURO per piscina interrata da 4 gradini – Inox

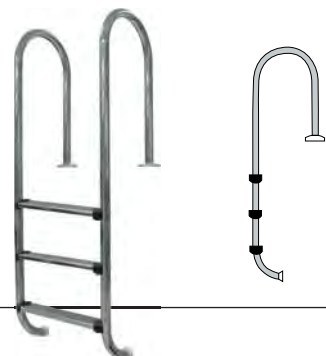

WALL

REF. 40273 **BXL PACK 1**



Escalera MURO para piscina enterrada de 3 peldaños – Inox
 Échelle MURALE acier inoxydable pour piscine enterrée - 3 marches

Stainless steel inground pool WALL ladder - 3 steps
 Scaletta MURO per piscina interrata da 3 gradini – Inox

ESCALERAS PARA PISCINA SOBRE SUELO ABOVE-GROUND POOL LADDERS
ÉCHELLES POUR PISCINES HORS SOL SCALETTA PER PISCINA FUORI TERRA



INOX

REF. AR11680

BXL PACK 1



8 412081 231082

Escalera de acero inoxidable 142cm
2x4 peldaños + plataforma

Stainless steel ladder 142cm
2x4 steps + platform

Échelle acier inoxydable 142cm
2x4 marches + plateforme

Scala in acciaio inossidabile 142cm
2x4 gradini + piattaforma



SAFETY

REF. ES1150

BXL PACK 1



8 412081 233765

Escalera de seguridad 134cm
2x3 peldaños + plataforma

Safety ladder 134cm
2x3 steps + platform

Échelle sécurité 134cm
2x3 marches + plateforme

Scala di sicurezza 134cm 2x3
gradini + piattaforma



SAFETY

REF. ES1100

BXL PACK 1



8 412081 233772

Escalera de seguridad 120cm
2x3 peldaños

Safety ladder 120cm
2x3 steps

Échelle sécurité 120cm
2x3 marches

Scala di sicurezza 120cm
2x3 gradini



SAFETY

REF. ES090

BXL PACK 1



8 412081 265094

Escalera de seguridad 98cm
2x2 peldaños

Safety ladder 98cm
2x2 steps

Échelle sécurité 98cm
2x2 marches

Scala di sicurezza 98cm
2x2 gradini





STANDARD
REF. ET1300

BXL PACK 1



Escalera 133cm
2x3 peldaños + plataforma
Échelle 133cm
2x3 marches + plateforme

Stainless 133cm
2x3 steps + platform
Scala 133cm
2x3 gradini + piattaforma



STANDARD
REF. ET1200

BXL PACK 1



Escalera tipo tijera 120cm
2x3 peldaños
Échelle 120cm
2x3 marches

Ladder 120cm
2x3 steps
Scala 120 cm
2x3 gradini



STANDARD
REF. AR109

BXL PACK 1



Escalera tipo tijera 98cm
2x2 peldaños
Échelle 98cm
2x2 marches

Ladder 98cm
2x2 steps
Scala 98cm
2x2 gradini

MONOBLOCS DE FILTRACIÓN FILTRATION KITS ENSEMBLES DE FILTRATION FILTRO MONOBLOCCO

Las impurezas quedan retenidas en el medio filtrante en el interior de la cuba. Son muy compactos, fáciles de instalar, utilizar y no requieren especial atención. Incorporan un prefiltro para retener las partículas excesivamente grandes y evitar dañar la bomba (*). Gracias a su válvula selectora (5/6/7 vías dependiendo del modelo), permiten realizar diferentes funciones: autolimpiado, filtración, vaciado... Los filtros FA6100 / FA6080 / FA6070 / FA6050 / FA6040 / FA6030 están certificados con la norma francesa NF P 90-318 que garantiza que cumplen con las normativas de seguridad establecidas.

Impurities are held by the filter media inside the tank. Sand filters are compact sized, easy to install and use and special care is not required. They include a prefilter to hold the largest particles to prevent pump from any damage (*). Thanks to their multiport valves (5/6 ways depending on the version), different functions can be carried out: self-cleaning, filtration, emptying... Filters FA6100 / FA6080 / FA6070 / FA6050 / FA6040 / FA6030 are certified with the standard French NF P 90-318 ensuring that they comply with the safety regulations set.



REF. FA6100



REF. FA6080



REF. FA6070



REF. FA6050



REF. FA6040



REF. FA6030



W

HP



EAN 13

FA6100	Ø 600 mm	10.000 l/h	485 W	0,66 CV/HP	±130 kg	6	BXL pack 1	
FA6080	Ø 500 mm	8.000 l/h	630 W	0,86 CV/HP	±90 kg	6	BXL pack 1	
FA6070	Ø 430 mm	7.000 l/h	230 W	0,31 CV/HP	±68 kg	6	BXL pack 1	
FA6050	Ø 380 mm	5.000 l/h	180 W	0,24 CV/HP	±46 kg	5	BXL pack 1	
FA6040	Ø 380 mm	4.000 l/h	125 W	0,17 CV/HP	±46 kg	5	BXL pack 1	
FA6030	Ø 300 mm	3.000 l/h	125 W	0,17 CV/HP	±23 kg	5	BXL pack 1	

compléments **complementi**

Les impuretés sont retenues dans le média filtrant à l'intérieur de la cuve. Ces filtres sont très compacts et très faciles à installer et à utiliser, sans grandes exigences. Le filtre est muni d'un pré filtre qui retient les particules excessivement grandes pour éviter d'endommager la pompe (*). Sa vanne multivoie (5/6 voies, suivant le modèle), permet de réaliser diverses fonctions: auto nettoyage, filtrage, vidange... Les filtres FA6100 / FA6080 / FA6070 / FA6050 / FA6040 / FA6030 sont certifiés par la norme française NF P 90-318 garantissant qu'ils respectent les réglementations établies en matière de sécurité.

Le impurità rimangono intrappolate nelle cariche filtrante all'interno del cestello. Sono molto compatti, facili da installare e da utilizzare e non richiedono cure particolari. Sono composti da un prefiltro per trattenere le particelle eccessivamente grandi ed evitare il danneggiamento della pompa(*). Grazie alla valvola selettiva della quale sono dotati (5/6/7 uscite a seconda del modello), consentono diverse funzioni: autopulizia, filtrazione, svuotamento... I filtri FA6100 / FA6080 / FA6070 / FA6050 / FA6040 / FA6030 sono certificati dalla normativa francese NF P 90-318 che garantisce la loro conformità alle normative di sicurezza vigenti.



REF. FS500



Con temporizador
With timer
Avec minuteur
Con temporizzatore

REF. FS400T



REF. FS400



REF. FS300



*Sin prefiltro
*Without prefilter
*Sans préfiltre
*Senza prefiltro

REF. FS300NP



NEW
*Sin prefiltro
*Without prefilter
*Sans préfiltre
*Senza prefiltro

REF. FS250NP



W

HP



EAN 13

	Ø	Flow	W	HP	Weight	Quantity	Pack	Barcode
FS500	Ø 500 mm	8.000 l/h	550 W	0,75 CV/HP	±85 kg	5	BXL pack 1	8 4 12081 252339
FS400T	Ø 400 mm	6.000 l/h	230 W	0,34 CV/HP	±40 kg	5	BXL pack 1	8 4 12081 257495
FS400	Ø 400 mm	6.000 l/h	230 W	0,31 CV/HP	±40 kg	5	BXL pack 1	8 4 12081 252322
FS300	Ø 300 mm	4.000 l/h	180 W	0,24 CV/HP	±20 kg	5	BXL pack 1	8 4 12081 252315
FS300NP	Ø 300 mm	4.000 l/h	180 W	0,24 CV/HP	±20 kg	5	BXL pack 1	8 4 12081 257488
FS250NP	Ø 250 mm	4.000 l/h	180 W	0,24 CV/HP	±14 kg	5	BXL pack 1	8 4 12081 264394

CARGAS FILTRANTES FILTER MEDIA MÉDIAS FILTRANTS CARICO FILTRO

REF. AR200

PB PACK 1



Arena - Silex 25kg. Granulometría 0,4-0,8.
Sable - Silex 25kg. Granulométrie 0,4-0,8.

Sand - Silex 25 kg. Grain size 0,4-08.
Sabbia - Silex 25kg. Granulometria 0,4-0,8.



REF. VF025

PB PACK 1



Vidrio filtrante saco 25kg
Granulometría 0,5 - 1 mm
Verre filtrant 25kg
Granulométrie 0,5 - 1 mm

Glass filter media 25 kg
Grain size 0,5 - 1 mm
Vetro filtrante 25kg
Granulometria 0,5 - 1 mm



SKIMMERS SKIMMERS SKIMMERS SKIMMERS

REF. AR100

BXL PACK 1



Skimmer + boquilla de impulsión
Skimmer + buse de refoulement
Skimmer + return fitting
Skimmer + bocchetta

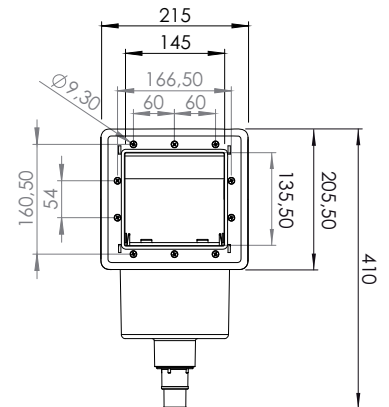

REF. AR100W

BXL PACK 1



Skimmer + boquilla de impulsión
Skimmer + buse de refoulement
Skimmer + return fitting
Skimmer + bocchetta



REF. 042734

DIS PACK 36



Water Lily

Colocado en la superficie del agua en el interior de la cesta skimmer, absorbe y retiene las materias grasas acumuladas por la circulación del agua.

Water Lily

Posé à la surface de l'eau dans le panier de skimmer, Water Lily absorbe et retient les substances grasses.

Water Lily

Placed in the basket skimmer, absorbs and retains all oily substances brought through by the circulating water.

Water Lily

Posta sulla superficie dell'acqua nel cestello dello skimmer, assorbe e trattiene le sostanze grasse raccolte grazie alla circolazione dell'acqua.



**FILTROS DE CARTUCHO CARTRIDGE FILTER
EPURATEUR À CARTOUCHE FILTRI A CARTUCCIA**

Están especialmente concebidos para piscinas con un volumen de agua medio-inferior. Son muy sencillos de utilizar y su mantenimiento se limita a la limpieza o sustitución del cartucho o filtro de recambio, cuando éste ha quedado obstruido por la excesiva carga de suciedad.

Ils sont spécialement conçus pour les piscines d'un volume d'eau moyen inférieur. Ils sont très faciles à utiliser et l'entretien se limite au nettoyage ou au remplacement de la cartouche ou du filtre, quand il est bouché par un excès de saletés.

Specially designed for medium-low water volume pools. Cartridge filters are very easy to use and their maintenance is limited to the cartridge cleaning or replacement when dirt is blocking it.

Pensati specialmente per piscine con un volume di acqua medio-basso. Sono molto semplici da usare e la manutenzione si limita alla pulizia o sostituzione della cartuccia o della cartuccia di ricambio, quando questa è ostruita da eccessive impurità.



REF. AR125





REF. AR124
REF. AR121E



W



EAN 13

AR125	3.800 l/h	70 W	AR82	BXL pack 1	
AR124	3.800 l/h	70 W	AR82	BXL pack 1	
AR121E	2.000 l/h	72 W	AR86	BXL pack 1	

**CARTUCHOS CARTRIDGES
CARTOUCHES CARTUCCIA**

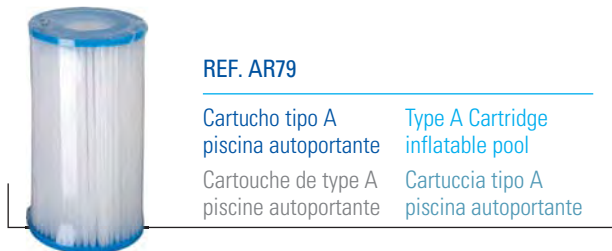

REF. AR79

Cartucho tipo A piscina autoportante
Type A Cartridge inflatable pool
Cartouche de type A piscine autoportante
Cartuccia tipo A piscina autoportante



REF. 90182

Limpiador de cartucho de filtro
Filter cartridge cleaner
Nettoyeur de cartouche de filtre
Pistola per pulire le cartucce





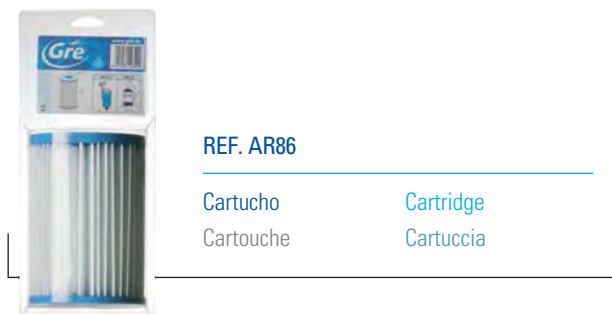

EAN 13



REF. AR86

Cartucho
Cartouche
Cartridge
Cartuccia

AR86	AR121/118	CS pack 12	
AR82	AR125/124/118	CS pack 12	
AR89	AR11806	CS pack 12	
AR79	Type A	PB pack 18	

TRATAMIENTO DE AGUA WATER TREATMENT TRAITEMENT DE L'EAU TRATTAMENTO ACQUA

Electrolisis de sal

Los cloradores por electrolisis de sal generan cloro para la desinfección de la piscina a partir de sal. La electrolisis de sal tiene varias ventajas: genera y dosifica automáticamente el cloro en la piscina, evita el almacenamiento y la manipulación de producto químico y es totalmente seguro, ya que sólo utiliza sal común.

Electrolyse au sel

Les chlorinateurs par électrolyse au sel génèrent du chlore pour la désinfection de la piscine grâce au sel. L'électrolyse au sel présente plusieurs avantages : Elle génère et dose automatiquement le niveau de chlore dans la piscine, évite le stockage et la manipulation de produits chimiques et est complètement sûre, étant donné qu'elle n'emploie que du sel commun.

Electrolysis of salt

Through electrolysis of salt, the chlorinators generate chlorine and salt to disinfect the swimming pool. The electrolysis of salt has various advantages: Generating and automatically dosing the chlorine in the swimming pool, avoids the handling and storage of chemical products and it completely safe, using only sodium chloride.

Elettrolisi salina

I clorinatori per elettrolisi salina producono cloro per la disinfezione della piscina partendo dal sale. L'elettrolisi salina ha diversi vantaggi: produce e provvede al dosaggio automatico del cloro nella piscina, evita l'immagazzinamento e l'uso di prodotti chimici ed è del tutto sicura in quanto fa uso del sale comune.



Ref. EES080PH
BX PACK 1
8 412081 250663

Ref. EES050PH
BX PACK 1
8 412081 250670

Ref. EES025PH
BX PACK 1
8 412081 250687



Ref. EES080
BX PACK 1
8 412081 240800

Ref. EES050
BX PACK 1
8 412081 240794

Ref. EES025
BX PACK 1
8 412081 240787

Electrolisis de sal para piscinas enterradas Generación automática de cloro y dureza del agua. Inversión automática de polaridad. Apta para temperatura de agua superior a 15°C y un pH entre 7,0 y 7,2.

Chlorinateur pour piscines enterrées Production automatique de chlore et augmentation de la dureté de l'eau. Inversion automatique de la polarité. Adapté à la température de l'eau supérieure à 15 °c et un pH compris entre 7.0 et 7.2.

Salt chlorinator for in-ground pools Automatic chlorine and water hardening creation. Automatic polarity reversal. Suitable for water temperatures above 15 °C and a pH reading between 7.0 and 7.2.

Clorinatore di piscine interrante Generazione automatica di cloro e durezza dell'acqua. Esclusivamente per piscine interrante. Inversione di polarità automatica. Adatto per acque con temperature superiori a 15°C e pH tra 7.0 e 7.2.

	EES025PH EES025	EES050PH EES050	EES080PH EES080
	Hasta 25 m ³ Jusqu'à 25 m ³ Until 25 m ³ Fino a 25 m ³	Hasta 50 m ³ Jusqu'à 50 m ³ Until 50 m ³ Fino a 50 m ³	Hasta 80 m ³ Jusqu'à 80 m ³ Until 80 m ³ Fino a 80 m ³
Tensión de servicio Standard working voltage Tension de service standard Tensione di lavoro	230 V AC, 50 Hz./60 Hz.		
Salida (dc) Output (dc) Sortie (dc) Uscita (c.c.)	3.5 A x 2	6 A x 2	3.5 A x 6
Producción (g/h) Production (g/h) Production (g/h) Produzione (g/h)	6 - 7	10-12	17-21
Capacidad piscina (m ³) Pool volume (m ³) Capacité piscine (m ³) Volume piscina (m ³) Templado: 16-24°C Warm 16-24°C Tempéré: 16-24°C Calore: 16-24°C Cálido: +25°C Hot: +25°C Chaud: +25°C Calore: +25°C	40 25	60 50	100 80
Detector flujo Flow detector Décteur flux Rilevatore di flusso	Detector gas Gas detector Décteur gaz Rilevatore di gas		
Rango de salinidad/Temperatura Salinity / Temperature range Niveau de salinité / Température Grado di salinitá / Range di temperatur	3 12 g./l. / +15 - 40°C		
Electrodos Electrodes Électrodes Elettrodi	Titanio con recubrimiento AUTO-LIMPIANTE, calidad ESTANDAR. Duración estimada: 3.000-5.000 horas (dependiendo de la calidad del agua)	SELF-CLEANING coated Titanium Estimated lifetime: 3.000-5.000 hours of operation (depending on water quality)	
	Titane avec recouvrement AUTO-NETTOYANTE. Temps de vie PRÉVU: 3.000-5.000 heures (suivant la qualité de l'eau)	Autopulenti rivestiti in titanio. Tempo di vita 3.000 - 3.500 H (dipende dalla qualità dell'acqua)	
Control producción Production control Contrôle production Controllo produzione	0 - 100 % (5 niveles de producción) 0 - 100 % (5 production levels) 0 - 100 % (5 niveaux de production) 0 - 100 % (5 livelli di produzione)		
Inversión polaridad Polarity switch Inversion polarité Inversione di polarità	Programmable: 2 ⁽¹⁾ / 3 horas (jumper en plac de control) + modo test Programmable: 2 ⁽¹⁾ / 3 hours (jumper in control board) + test mode Programmable: 2 ⁽¹⁾ / 3 heures (jumper en plaque de contrôle) + mode test Programmabile: 2 ⁽¹⁾ / 3 ore con quadro di controllo e test mode		
Protección nivel de sal Salt level protection Protection niveau de sel Protezione livello sale	Protección automática de producción Automatic protection of output current Protection automatique de production Protezione automatica di corrente in uscita		

⁽¹⁾ Configuración fábrica Factory default Réglages usine Impostazione di fabbrica

REF. AR2084 CBX PACK 2



Clorador de piscina elevadas

Sistema que desinfecta el agua de la piscina convirtiendo por electrolisis el cloruro sódico (sal) en iones de cloro. Fácil instalación. Utilizar solo Cloruro sódico con pureza 99%.

Chlorinateur pour des piscines hors sol

Système de désinfection de l'eau de la piscine par conversion au procédé d'électrolyse du chlorure de sodium (sel) en ions de chlore. Installation facile. Utilisable exclusivement avec du chlorure de sodium d'une pureté de 99%.

Salt chlorinator for above-ground pools

This system disinfects pool water through the electrolysis. It transforms the sodium chloride (salt) into chlorine ions. Easy to install. Use only 99 % pure salt.

Clorinatore per piscine fuori terra

Sistema che disinfecta l'acqua della piscina convertendo attraverso elettrolisi il cloruro di sodio (sale) in ioni cloruro. Facile installazione. Usare solo cloruro di sodio puro al 99%.

complementos complements

Electrólisis de sal para piscinas elevadas y enterradas
Electrolyse au sel pour piscines enterrées et hors sol

Salt chlorinator for above ground and in ground pools
Elettrolisi salina per piscine interrate e fuori terra

GRE SALT OPTIMUS

REF. ESP100 BXL PACK 1



Hasta 100m³
Producción de cloro: 19-21 g/h
Jusqu'à 100m³
Production de chlore: 19-21 g/h

Until 100m³
Chlorine production: 19-21 g/h
Fino a 100m³
Produzione di cloro: 19-21 g/h

REF. ESP60 BXL PACK 1



Hasta 60m³
Producción de cloro: 13-15 g/h
Jusqu'à 60m³
Production de chlore: 13-15 g/h

Until 60m³
Chlorine production: 13-15 g/h
Fino a 60m³
Produzione di cloro: 13-15 g/h

REF. ESP30 BXL PACK 1



Hasta 30m³
Producción de cloro: 7,5-8,5 g/h
Jusqu'à 30m³
Production de chlore: 7,5-8,5 g/h

Until 30m³
Chlorine production: 7,5-8,5 g/h
Fino a 30m³
Produzione di cloro: 7,5-8,5 g/h



REF. EESB55 BXL PACK 1



Hasta 55m³
Fácil instalación, sin
mantenimiento

Jusqu'à 55m³
Production de chlore: 13-15 g/h
Facile à installer, sans
maintenance

Until 55m³
Chlorine production: 13-15 g/h
Easy installation, maintenance
free

Fino a 55m³
Produzione di cloro: 13-15 g/h
Semplice da installare, non
necessita di manutenzione





REF. 90365

PB PACK 1



Sal compacta
saco 25kg

Compact salt
bag 25kg

Sel compacté
sac 25kg

Sale compatto
25kg

REF. CPH14

BXL PACK 1



El controlador de pH con bomba peristáltica para piscina enterrada automatiza la regulación del pH, lo que permite estabilizar el pH en el valor ideal para su confort y optimizar la eficacia del tratamiento de desinfección.

Le contrôleur de pH avec pompe péristaltique pour piscine enterrée automatise la régulation du pH, ce qui permet de stabiliser le pH sur la valeur idéale pour votre confort et optimiser l'efficacité du traitement de désinfection.

pH-Control dosing system is a peristaltic pump designed to maintain a chosen pH level on inground pools, allowing stabilize the pH in the ideal value for comfort and to optimize the efficiency of the disinfection treatment.

Il regolatore di pH con pompa peristaltica per piscine interrata automatizza la regolazione del pH consentendo di stabilizzarlo su un valore ideale e ottimizzando l'efficacia del trattamento di disinfezione.

REF. BDP4

BXL PACK 1



Bomba dosificadora peristáltica. Caudal variable 4 l/h y 1,5 Bar. Permite dosificar el producto químico de forma fácil y segura.

Pompe doseuse péristaltique. Vitesse variable 4l/h et 1,5 bar. Permet le dosage de produit chimique de façon facile et précise.

Peristaltic dosing pump. Variable flow rate. 4 l/h and 1,5 Bar. Safe and easy way of dosing of the chemical product UV-C.

Pompa per il dosaggio del prodotto chimico. Pressione variabile 4 l/h e 1,5 Bar

TECHNICAL ROOM

REF. ARNP30

BXL PACK 1



LOCAL TÉCNICO

Local técnico fabricado en madera de pino nórdico, tratamiento nivel IV clase V. Con apertura frontal y superior. Incluye troquelado para conexiones. De fácil montaje (se sirve desmontado). Medidas int.: 107x73x91cm. No incluye filtro.

LOCAL TECHNIQUE

Local technique en pin du Nord, traitement niveau IV classe V. Avec ouverture frontale et supérieure. Inclut ouverture pour connexions. Montage facile (livré démonté). Dimensions intérieures : 107x73x91cm. N'inclut pas le filtre.

TECHNICAL ROOM

Technical room made of nordic pine wood with level IV class V treatment. Upper and front opening. Connection holes included. Easy to assemble (served dismantled). Inside measurements: 107x73x91 cm. Filtration equipment not included.

LOCALE TECNICO

Locale tecnico in legno di pino nordico, trattamento livello IV classe V. Con apertura frontale e superiore. Include stampigliatura per connessioni. Di facile montaggio (si fornisce smontato). Misure int.: 107x73x91cm. Filtro non incluso.

complementos complements

BOMBAS PUMPS POMPES POMPE

Gama de bombas autoaspirantes GRE con potencias comprendidas entre 1/3 CV y 2 CV. Se trata de bombas centrifugas de una sola etapa, autocebantes, concebidas para uso con un sistema de filtración de piscina.

Gamme de pompes GRE, avec des puissances comprises entre 1/3 CV et 2 CV. Il s'agit de pompes centrifuges, auto-amorçantes, conçues pour une utilisation avec un système de filtration de piscine.

The self-priming pump range GRE emits power between 1/3 CV and 2 CV. Centrifugal pumps are single stage, self-priming pumps designed for use in a swimming pool filtration systems.

Gamma di pompe autoaspiranti GRE con potenze comprese tra 1/3 CV e 2 CV. Si tratta di pompe centrifughe monostadio, autoadesanti, concepite per l'uso con un sistema di filtrazione per piscina.

PREMIUM

- REF. PP200 CBX PACK 1
- REF. PP150 CBX PACK 1
- REF. PP100 CBX PACK 1



Curvas de rendimiento hidráulico
Hydraulic performance curves
Courbes de performances hydrauliques
Curve delle prestazioni idrauliche

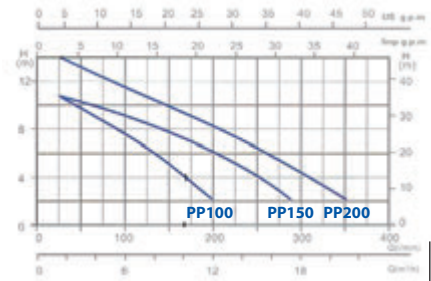

COMFORT

- REF. PP075 CBX PACK 1
- REF. PP050 CBX PACK 1
- REF. PP030 CBX PACK 1



Curvas de rendimiento hidráulico
Hydraulic performance curves
Courbes de performances hydrauliques
Curve delle prestazioni idrauliche

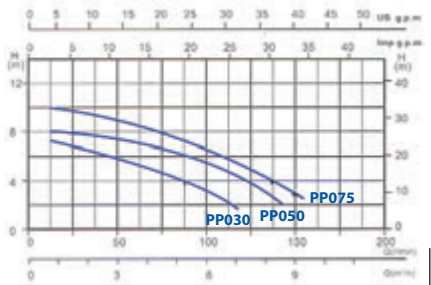

HP

W



EAN 13

	HP	W		 max.		EAN 13
PP200	2 CV/HP	1600 W	27.000 l/h	170m ³	Ø 800 mm	 8 4 1 2 0 8 1 2 3 7 5 8 9
PP150	1,5 CV/HP	1100 W	22.000 l/h	135m ³	Ø 700 mm	 8 4 1 2 0 8 1 2 3 7 5 9 6
PP100	1 CV/HP	900 W	20.000 l/h	100m ³	Ø 600 mm	 8 4 1 2 0 8 1 2 3 7 6 0 2
PP075	3/4 CV/HP	550 W	9.500 l/h	65m ³	Ø 500 mm	 8 4 1 2 0 8 1 2 3 7 6 1 9
PP050	1/2 CV/HP	450 W	8.500 l/h	50m ³	Ø 400 mm	 8 4 1 2 0 8 1 2 3 7 6 2 6
PP030	1/3 CV/HP	250 W	7.000 l/h	35m ³	Ø 300 mm	 8 4 1 2 0 8 1 2 3 7 6 3 3

ILUMINACIÓN LIGHTING
ÉCLAIRAGE ILLUMINAZIONE



REF. LLEDP56W

CBX PACK 1



Lámpara LED BLANCA PAR56 de muy fácil instalación 100% fabricada en EU (fábrica propia). Los LED ofrecen una vida útil de 100.000h y un flujo del 70% transcurridas 60.000h. Importantes ahorros en energía respecto a una lámpara halógena: hasta un 92%. 3 años de garantía.

Ampoule LED BLANCHE PAR56 très facile à installer 100% fabriquée dans la CEE (usine propre). Les ampoules offrent une durée de vie de 100 000 h et un flux de 70% après 60.000h. Importantes économies d'énergie par rapport à une ampoule halogène: jusqu'à 92%. 3 ans de garantie.

Easily installed PAR56 WHITE LED lamp 100% manufactured in EU (own production). LEDs has a useful life of 100,000 h and a 70% flow after 60,000 h. Important energy savings regarding a halogen lamp: up to 92%. 3 years guarantee.

Lampada PAR56 LED BIANCA PAR56 di semplicissima installazione, prodotta al 100% in EU (produzione propria). Offre una durata utile di 100.000 ore e un flusso del 70% dopo 60.000 ore. Ciò consente notevoli risparmi di energia rispetto a una lampada alogena: fino al 92% circa. 3 anni di garanzia.



REF. LLEDP56C

CBX PACK 1



Lámpara LED COLOR PAR56 de muy fácil instalación 100% fabricada en EU (fábrica propia). Los LED e ofrecen una vida útil de 100.000h y un flujo del 70% transcurridas 60.000h. Importantes ahorros en energía respecto a una lámpara halógena: hasta un 88%. 12 colores y 8 secuencias. 3 años de garantía.

Ampoule LED COULEUR PAR56 très facile à installer 100% fabriquée dans la CEE (usine propre). Les ampoules offrent une durée de vie de 100 000 h et un flux de 70% après 60 000 h. Importantes économies d'énergie par rapport à une ampoule halogène: jusqu'à 88%. 12 couleurs et 8 séquences. 3 ans de garantie.

Easily installed PAR56 COLOUR LED lamp 100% manufactured in EU (own production). LED has a useful life of 100,000 h and a 70% flow after 60,000 h. Important energy savings regarding a halogen lamp: up to 88% 12 colors and 8 sequences. 3 years guarantee.

Lampada LED COLOR PAR56 di semplicissima installazione, prodotta al 100% in EU (produzione propria). Offre una durata utile di 100.000 ore e un flusso del 70% dopo 60.000 ore. Ciò consente notevoli risparmi di energia rispetto a una lampada alogena: fino al 88% circa. 12 colori e 8 sequenze. 3 anni di garanzia.



REF. PLED1C

BL PACK 12



Proyector LED COLOR para piscina elevada de acero. Fácil instalación, se pega a la chapa mediante un imán. Incorpora mando a distancia para fácil manejo. Tecnología Led de bajo consumo.

Projecteur LED de COULEUR pour piscine hors sol. Ils sont spécialement conseillés pour les piscines hors sol en tôle. Se fixe simplement sur la tôle grâce à un aimant. Ils incorporent une télécommande très simple à utiliser. Technologie LED à faible consommation.

COLOR LED projector for above ground pools. Stick to the sheet with a magnet and ready to use. Includes remote control for easy operation. Energy-saving LED technology.

Faretto LED MULTICOLOR per piscina fuoriterra. Foglio adesivo con un magnete pronto all'uso. Include telecomando a distanza per un facile funzionamento. Risparmio energetico tecnologia al LED.

REF. PLED2

CS PACK 4



8 412081 250830

Conjunto de 2 proyectores LED BLANCOS para piscina elevada de acero. Fácil instalación, se pega a la chapa mediante un imán. Incorpora mando a distancia para fácil manejo. Tecnología Led de bajo consumo.

Ensemble de 2 projecteurs LED pour piscine hors sol. Il est spécialement conseillé pour les piscines hors sol en tôle. Se fixe simplement sur la tôle grâce à un aimant. Il incorpore une télécommande très simple à utiliser. Technologie LED à faible consommation.

Set of 2 WHITE LED projectors for above ground pools. Stick to the sheet with a magnet and ready to use. Includes remote control for easy operation. Energy-saving LED technology.

2 Faretto LED per piscina fuoriterra. Foglio adesivo con un magnete pronto all'uso. Include telecomando a distanza per un facile funzionamento. Risparmio energetico tecnologia al LED.



REF. PLCH144

BL PACK 1



8 412081 250816

Proyector 144 LEDs COLOR (RGB) piscina enterrada de HORMIGÓN.

Projecteur de 144 LEDS de COULEUR pour piscine enterrée BÉTON.

Projector with 144 LEDs, colour RGB for CONCRETE pools.

Faretto Ø 28 x 7, 144 LED MULTICOLOR RGB, per piscine interrate in MURATURA.

REF. PLCL144

BL PACK 1



8 412081 250823

Proyector 144 LEDs COLOR (RGB) piscina enterrada de LINER.

Projecteur de 144 LEDS de COULEUR pour piscine enterrée avec LINER.

Projector with 144 LEDs, colour RGB for LINER pools.

Faretto Ø 28 x 7, 144 LED MULTICOLOR RGB, per piscine interrate con LINER.



REF. PLBH144

BL PACK 1



8 412081 250793

Proyector 144 LEDs blanco piscina enterrada de HORMIGÓN.

Projecteur de 144 LEDS BLANCHES pour piscine enterrée BÉTON.

Projector with 144 white LEDs for CONCRETE pools

Faretto Ø 28 x 7, 144 LED color BIANCO, per piscine interrate in MURATURA.

REF. PLBL144

BL PACK 1



8 412081 250809

Proyector 144 LEDs BLANCO piscina enterrada de LINER.

Projecteur de 144 LEDS BLANCHES pour piscine enterrée LINER.

Projector with 144 WHITE LEDs for LINER in-ground pools.

Faretto Ø 28 x 7, 144 LED color BIANCO, per piscine interrate con LINER.





REF. LEDRW CBX PACK 12



Proyector LED BLANCO de alto rendimiento para conectar a la válvula de retorno. Adaptable a piscinas elevadas tanto autoportantes como de pared rígida. Caudal mínimo necesario: 3.000 l/h. Funciona sin necesidad de batería.

WHITE LED projector for connecting to the return valve. Adaptable for movable above ground pools with rigid walls. High performance WHITE LEDs. Generates light at no cost, does not need batteries. Minimal flow needed: 3000 l/h

Projecteur LED BLANCHE à haut rendement pour connecter à la buse de refoulement. Adaptable à des piscines hors-sol, aussi bien autoportantes qu'avec des parois rigides. Débit minimum nécessaire : 3 000 l/h. Fonctionne sans nécessité de batterie.

Proiettore LED BIANCO a resa elevata per connessione alla valvola di ritorno. Si adatta a piscine fuori terra, sia autoportanti che a parete rigida. Flusso minimo necessario: 3.000 l/h. Funziona senza batteria.



REF. LEDRC CBX PACK 12



Proyector LED COLOR de alto rendimiento para conectar a la válvula de retorno. Adaptable a piscinas elevadas tanto autoportantes como de pared rígida. Caudal mínimo necesario: 3.000 l/h. Funciona sin necesidad de batería.

COLOUR LED projector for connecting to the return valve. Adaptable for movable above ground pools with rigid walls. High performance COLOUR LEDs. Generates light at no cost, does not need batteries. Minimal flow needed: 3000 l/h

Projecteur LED COULEUR à haut rendement pour connecter à la buse de refoulement. Adaptable à des piscines hors-sol, aussi bien autoportantes qu'avec des parois rigides. Débit minimum nécessaire : 3 000 l/h. Fonctionne sans nécessité de batterie.

Proiettore LED COLOR a resa elevata per connessione alla valvola di ritorno. Si adatta a piscine fuori terra, sia autoportanti che a parete rigida. Flusso minimo necessario: 3.000 l/h. Funziona senza batteria.

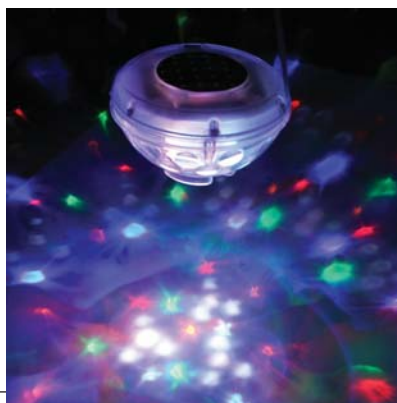

REF. 90173 CBX PACK 12



Lámpara fantasía
7 programas de luz diferentes.

Fancy lamp
7 different lighting programmes.

Lampe fantasie
sept jeux de lumière sur les parois et le fond de la piscine.

Lampada fantasia
ette giochi di luce differenti ai lati della piscina e sul fondo.



REF. 40710 BX PACK 12



Bombilla 300w para proyector.
Ampoule 300w pour projecteur.

300w bulb for underwater light.
Lampada 300w per faro.

CALEFACCIÓN HEATING SYSTEMS CHAUFFAGE RISCALDAMENTO



Bombas de calor

Sistema energético basado en el aprovechamiento de la energía exterior para calentar el agua de piscina, con relaciones de 1 kw consumido - 5 Kw aportados. Incluyen funda para su protección durante el invierno.

Heat pumps

Heating system based on the use of the energy coming from the external air to heat pool water in the ratio of 1 Kw of energy consumption to 5 Kw of output. Include cover for protection during the winter.

Pompe à chaleur

Système énergétique basé sur l'utilisation de l'énergie extérieure pour chauffer l'eau de la piscine avec un rapport de 1 Kw consommé - 5 Kw restitués. Bâche de protection hivernale pour pompe à chaleur est inclus.

Pompe di calore

Sistema di riscaldamento basato sull'uso dell'energia proveniente dall'aria esterna per riscaldare l'acqua della piscina nel rapporto di 1 Kw di consumo di energia per 5 Kw di potenza. Includono telo di protezione per l'inverno.



Model	Capacity	Flow	Power	Power	COP	HP/CV	Noise	Package	Barcode
BC3800	12.000 l	3.000 l/h	3.800 W	760 W	5	1 HP/CV	51 dB	BXL pack 1	8 412081 264639
BC4500	16.000 l	3.000 l/h	4.500 W	900 W	5	1,2 HP/CV	51 dB	BXL pack 1	8 412081 264455
BC9000	28.000 l	6.000 l/h	9.000 W	1.900 W	5	2,5 HP/CV	55 dB	BXL pack 1	8 412081 264462
BC13000	38.000 l	6.000 l/h	12.500 W	2.500 W	5	3,3 HP/CV	55 dB	BXL pack 1	8 412081 264479
BC21000	70.000 l	12.000 l/h	21.000 W	4.290 W	5	5,8 HP/CV	57 dB	BXL pack 1	8 412081 264486

Temperatura ambiental de 16°C, temperatura del agua 20°C y humedad del 70%. 16°C at room temperature, 20°C water temperature and 70% humidity.
Une température de l'air extérieur de 16°C, une température d'eau de 20°C et un taux d'humidité de 70%. Temperatura aria di 16°C, 70% umidità e temperatura acqua a 20°C.

REF. AR20753 BXL PACK 1



Intercambiador de calor

Sistema diseñado para calentamiento del agua de piscinas o spas. Recomendado principalmente para pequeños volúmenes de agua. Potencia 3 kw. Incorpora termostato, y gracias a su blindaje de titanio, apenas precisa mantenimiento

Réchauffeur électrique

Système conçu pour le chauffage de l'eau des piscines ou spas. Recommandé principalement pour des petits volumes d'eau. Puissance 3 kw. Il intègre un thermostat, et grâce à son blindage en titane, il ne nécessite quasiment pas d'entretien.

Electrical heat exchanger

System designed to heat pools or spas water. Recommended mainly for small volumes of water. Power output: 3 kw. Thermostat included. Little maintenance required due to its titanium shield.

Scambiatore di calore

Sistema disegnato per il riscaldamento dell'acqua di piscine o centri benessere. Raccomandato principalmente per piccoli volumi d'acqua. Potenza 3 kw. Include termostato e, grazie alla sua armatura in titanio, non ha praticamente bisogno di manutenzione.

REF. AR2000 BXL PACK 1



Kit Bypass

Contiene: 3 Válvulas apertura/cierre + 2 mangueras Ø38 mm x 1,5 m + 6 piezas de reducción Ø38 - 50 mm para encolar + 4 abrazaderas

Kit Bypass

Comprend: 3 vannes ouverture / fermeture + 2 tuyaux Ø38 cm x 1,5 m + 6 pièces réduction Ø38 - 50 mm à coller + 4 colliers

Bypass kit

Contains: 3 opening/closing valves + 2 hoses Ø38 mm x 1,5 m + 6 reduction parts Ø38 - 50 mm to glue + 4 lamps

Kit Bypass

Contiene: 3 valvole di apertura/chiusura + 2 tubi flessibili Ø38 cm x 1,5 m + 6 pezzi adattatori Ø38 - 50 mm da incollare + 4 fascette

**CALEFACCIÓN SOLAR SOLAR HEATING SYSTEM
CHAUFFAGE SOLAIRE RISCALDAMENTO SOLARE**

Sistemas para calentamiento del agua de la piscina mediante la acción solar. **Solar pool water heating systems.**
Chauffage solaire pour piscine. Fabriqué en polyéthylène. Sistema per il riscaldamento dell'acqua della piscina per mezzo dell'azione del sole.



REF. AR2069

CBX PACK 1



Fabricado en polietileno. Aumenta la Temperatura del agua hasta 6°C. Mas de 12 kw/h de calor al dia. 600x60 cm. Peso 7 kg. Potencia de la bomba mínima recomendada: 1/3 CV.

Made of polythene. Water temperature can be increased up to 6 °C. 600x60 cm. Wight: 7 kg. Minimum recommended pump output: 1/3 hp.

Il augmente la température de l'eau jusqu'à 6°C. 600x60 cm. Poids 7 kg. Puissance de la pompe minimale recommandée: 1/3 CV.

In polietilene. Aumenta la temperatura dell'acqua fino a 6°C. 600x60 cm. Peso 7 kg. Potenza minima della pompa raccomandata: 1/3 CV.



REF. AR20693

CBX PACK 1



Calentador solar de agua para piscinas autoportantes. Fabricado con materiales flexibles (nylon y pvc). Medidas: 130x80 cm. Peso 1,2 kg. Aumenta la Temperatura del agua hasta 4°C. Funciona con bomba de piscina desde 4m³/h.

Solar pool water heating system for inflatable pools. Made of flexible materials (nylon and pvc). Dimensions: 130x80 cm. Weight: 1,2 kg. Water temparaature can be increased up to 4°C. Minimum water volume: 4m³/h.

Rechauffeur solaire pour piscines autoportantes. Fabriqué avec des matériaux souples (nylon et pvc). Dimensions: 130x80cm. Poids 1,2 kg. Augmente la temperature de l'eau jusqu'a 4°C. Puissance de la pompe minimum recommandée: 4m³/h.

Sistema di riscaldamento solare di acqua per piscine autoportanti. Fabbriato con materiali flessibili (nylon e pvc). Misure: 130x80 cm. Peso 1,2 kg. Aumenta la temperatura dell'acqua fino a 4°C. Funziona con pompe da piscina da 4m³/h.



REF. 90230

CBX PACK 1



Permite aumentar la temperatura de su piscina por la acción del sol. Los calentadores pueden conectarse entre sí en serie. Aumenta la temperatura del agua 3°C en piscinas entre 7,5m³ y 10m³.

Solar pool water heating system. The heaters should be connected in series to heat the pool. Each solar heater increases the temperature of the swimming pool by 3°C due to solar action.

Système pour le chauffage solaire de l'eau de la piscine. Les réchauffeurs peuvent se connecter entre eux en série. Augmente la température de 3°C max. pour les piscines entre 7,5m3 et 10m3.

Permette di aumentare la temperatura della sua piscina tramite l'azione dei raggi solari. Ogni riscaldatore solare permette di aumentare la temperatura della piscina no a 3°C tramite l'azione naturale del sole.

DUCHAS SHOWERS DOUCHES DOCCIA





REF. DSALR32W
BXL PACK 1

8 412081 238135

Ducha solar redonda 32l Aluminio aspecto madera Con grifo lavapies	Round solar shower 32l Aluminium Woodlike With footwash tap
Douche solaire ronde 32l Aluminium Aspect bois Avec robinet lave pieds	Doccia solare round 32l Alluminio Imitazione legno Rubinetto lavapiedi





REF. DSALC32W
BXL PACK 1

8 412081 238142

Ducha solar cuadrada 32l Aluminio Aspecto madera Con grifo lavapies	Square solar shower 32l Aluminium Woodlike With footwash tap
Douche solaire carrée 32l Aluminium Aspect bois Avec robinet lave pieds	Doccia solare square 32l Alluminio Imitazione legno Rubinetto lavapiedi



REF. AR1130
BXL PACK 1

8 412081 224510

Ducha solar de jardín 32l Aluminio Con nebulizador y grifo lavapies	Round solar shower 32l Aluminium Woodlike With footwash tap
Douche solaire 32 litres avec brumisateur et lave-pieds Aluminium	Doccia solare 32l Alluminio Nebulizzatore e rubinetto lavapiedi



REF. AR1035
BXL PACK 1

8 412081 230931

Ducha solar 38l - PVC Douche solaire de jardin 38l - PVC	Garden solar shower 38l - PVC Doccia solare 38l - PVC
--	---



REF. AR1030
BXL PACK 1



8 412081 220765

Ducha solar 30l
PVC
Garden solar
shower 30l - PVC

Douche solaire de jardin
30l - PVC
Doccia solare 30l - PVC



REF. AR10250
BXL PACK 1



8 412081 224497

Ducha solar 20l
PVC
Garden solar
shower 20l - PVC

Douche solaire de jardin
20l - PVC
Doccia solare 20l - PVC



REF. 40664A
BXL PACK 1



8 427370 406645

Ducha solar 20l
PVC
Garden solar
shower 20l - PVC

Douche solaire de
jardin 20l - PVC
Doccia solare 20l - PVC



REF. AR1020W
BXL PACK 1



8 412081 264387

Ducha solar 20l
PVC aspecto madera
Solar shower 20l
Woodlike PVC

Douche solaire 20l
PVC Aspect bois
Doccia solare 20l
PVC Imitazione legno

complementos complements

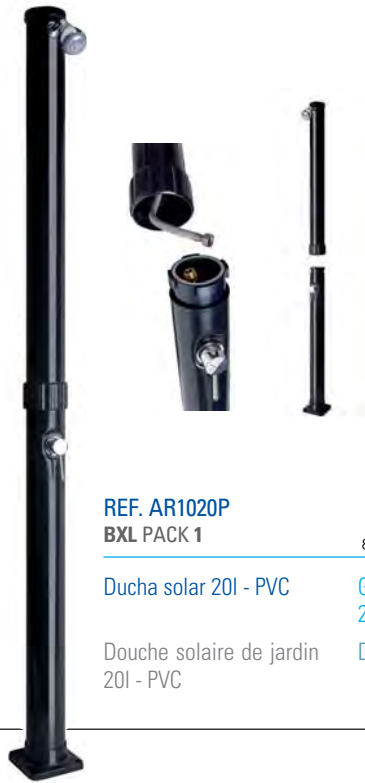

REF. AR1020P
BXL PACK 1



8 412081 240817

Ducha solar 20l - PVC

Garden solar shower
20l - PVC

Douche solaire de jardin
20l - PVC

Doccia solare 20l - PVC



REF. AR1009
BXL PACK 1



8 412081 264370

Ducha solar 9l - PVC

Garden solar shower
9l - PVC

Douche solaire de jardin
9l - PVC

Doccia solare 9l - PVC

REF. AR104 **CBX PACK 12**



8 412081 950716

Ducha aluminio. Fácil
instalación y conexión.

Aluminium shower.
Easy installation and connection.

Douche en aluminium.
Montage et raccordement facile

Doccia alluminio. Facilità di
installazione e collegamento.





REF. DPE10

CBX PACK 12



Ducha para piscina sobre suelo. Con sistema de fijación al pasamanos de la escalera.

Above-ground pool shower. With stair railings fixing system. No tools required.

Douche pour piscine hors sol. Système de fixation à mâchoire universelle pour échelle tubulaire ou autres supports

Doccia per piscine fuori terra. Con sistema di fissaggio al corrimano della scaletta.



REF. SP7212

CBX PACK 1



Ducha-base de jardin automática. Se activa con el peso, al subirse a la base comienza a salir agua. Se conecta a una manguera de jardín.

Automatic garden Shower-base automatic garden. Weight activated, just climb on and start showering. Connection for a garden hose.

Douche base de jardin automatique. Il suffit de marcher dessus pour se doucher. Activation par la charge de poids. Connexion pour le tuyau d'arrosage.

Basta saltarci sopra e la doccia si attiva. Attivazione al rilevamento del peso. Attacco al tubo flessibile da giardino



REF. SSB40

BXL PACK 1



Base para ducha solar 60x60cm. Lamas imitación madera

Solar shower base 60x60cm Wood aspect slat.

Socle pour douche solaire 60x60cm. Lattes aspect bois

Base per doccia solare 60x60cm Listelli imitazione legno



REF. LP01

BX PACK 24



Lavapiés

Footwash

Pédiluve

Lavapiedi

REPUESTOS SPARE PARTS PIÈCES DE RECHANGE PARTI



REF. AR500
CS PACK 6 8 4 1 2 0 8 1 2 0 6 4 6 2

Cesto para skimmer
Skimmer Basket
Panier pour skimmer
Cesto prefiltro
Ø ext. 16,2 cm ↑5,5 cm Ø int. 11 cm



REF. AR501
CS PACK 12 8 4 1 2 0 8 1 2 0 6 4 8 6

Compuerta para skimmer
Weir for skimmer
Volet pour skimmer
Sportellino
12 x 14,5 x 2 cm



REF. AR502
CS PACK 12 8 4 1 2 0 8 1 2 0 6 4 9 3

Giunto doppio di stagno
Skimmer layer
Joint pour skimmer
Giunto doppio di stagno
ext. 20,5 x 19,5 x 0,5 cm
int. 14,8 x 13,9 x 0,5 cm



REF. AR521
CS PACK 12 8 4 1 2 0 8 1 2 5 0 7 4 8

Junto doble skimmer + 2 juntas de
válvula de retorno
Double seal for skimmer + 2 seals for
return valve
Joint double skimmer + 2 joints
pour buse de refoulement
Guarnizione doppia standard Skimmer +
2 guarnizioni per la valvola di ritorno



REF. AR503
CS PACK 6 8 4 1 2 0 8 1 2 0 6 5 0 9

Boquilla de impulsión
Return fitting
Buse de refoulement
Valvola di impulsione completa



REF. AR505
CS PACK 8 8 4 1 2 0 8 1 2 0 8 6 1 9

Tapa para conexión de manguera
limpiafondos
Lid for connecting the vacuum
hose to the skimmer
Couvercle pour relier le tuyau
flottant au skimmer
Adattatore per puliscifondo



REF. AR506
CS PACK 8 8 4 1 2 0 8 1 2 0 8 6 0 2

Manómetro
Pressure gauge
Manomètre
Manometro



REF. AR512
CS PACK 12 8 4 1 2 0 8 1 2 2 1 6 0 1

Válvula apertura/cierre Ø38-Ø32
Open/close valve Ø38-Ø32
Vanne ouverture/fermeture Ø38-Ø32
Valvola di apertura/chiusura Ø38-Ø32

compléments **complementi**



REF. AR508
CS PACK 11 8 4 120 81 208 589

Zuncho universal
Filter ring
Collier de fixation
Ghiera filtro



REF. AR510
CS PACK 24 8 4 120 81 215 785

Cintaflón y 4 abrazaderas
Cintaflon and 4 clamps
Teflon et 4 colliers
Nastro Teflon e 4 fascette



REF. Y12
CS PACK 50 8 4 120 81 940 861

2 filtros para limpiafondos ventury
2 filters for ventury bottom cleaner
2 filtres pour aspirateur de fond
2 filtri per puliscifondo venturi



REF. 40045
CS PACK 30 8 4 273 70 400 452

10 filtros de skimmer
10 filter savers
10 filtres pour skimmer
10 filtri di skimmer



REF. 40080
BL PACK 24 DIS 8 4 273 70 400 803

Kit reparación liner
Liner repair kit
Kit réparation liner
Kit riparazione liner



REF. V12
BL PACK 50 8 4 120 81 870 236

Kit reparador de PVC
PVC repair kit
Kit réparation PVC
Kit per riparazioni PVC



REF. AR202
BL PACK 96 8 4 120 81 960 203

Film reparador de PVC
PVC repair film
Film réparation PVC
Pellicola per riparare i liner



Leyenda Legend Légende Legenda

BX

caja
box
box
scatola

BXL

caja con etiqueta
box and label
carton avec étiquette
scatola con etichetta

CB

cartoncillo
cardboard wrap
bande carton
cartone

CBX

caja litografiada
colour box
boîte de couleur
scatola serigrafata

PB

bolsa de plástico
polybag
sac plastique
busta di plastica

PBH

bolsa de plástico con cartoncillo
polybag with header
sac plastique avec bande carton
sacchetto di plastica con cartone

BL

blister
blister
blister
blister

CS

doble burbuja
clamshell
double coque
doppio rivestimento

DIS

display
display
display
display



manguera
hose
tuyau
tubo



cable
wire
câble
cavo

material de cleaning limpieza material

MATERIAL DE LIMPIEZA	90	CLEANING MATERIAL
Robots	92	Robots
Limpiafondos eléctricos	97	Electric cleaners
Limpiafondos automáticos	98	Automatic cleaners
Limpiafondos de aspiración	100	Vacuum cleaners
Limpiafondos Ventury	101	Ventury vaccum
Kits limpiafondos	102	Vacuum cleaners kits
Gama Superluxe	103	Superluxe range
Recogehojas	104	Leaf nets and rakes
Limpiafondos manuales	105	Vacuum heads
Dosificadores	106	Dispensers
Cepillos	107	Brushes
Termómetros	108	Thermometers
Mangos telescópicos	109	Telescopic handles
Productos complementarios	110	Complementary products
Mangeras flotantes	111	Vacuum hoses
Racordería	114	Fittings
Protección invierno	115	Winter protection

matériel de cleaning nettoyage material

MATÉRIEL DE NETTOYAGE	92	MATERIALE DI PULIZIA
Robots	94	Robots
Nettoyeurs de fond électriques	98	Pulitore elettrico
Nettoyeurs automatiques	98	Puliscifondi automatici
Nettoyeurs pour aspiration	100	Pulitore fondo ad aspirazione
Aspirateurs de fond ventury	101	Puliscifondi Ventury
Kit nettoyeurs	102	Kit Pulitore fondo
Gamme Superluxe	103	Gamma Superluxe
Épousettes	104	Raccoglitori
Balais manuels	105	Puliscifondo manuale
Doseurs	106	Dosatori
Brosses	107	Spazzole
Thermomètres	108	Termometri
Manches télescopiques	109	Manico telescopico
Produits complémentaires	110	Prodotti complementari
Tuyaux flottants	111	Tubi galleggianti
Raccords PVC	114	Raccorderia in PVC
Protection hiver	115	Protezione inverno

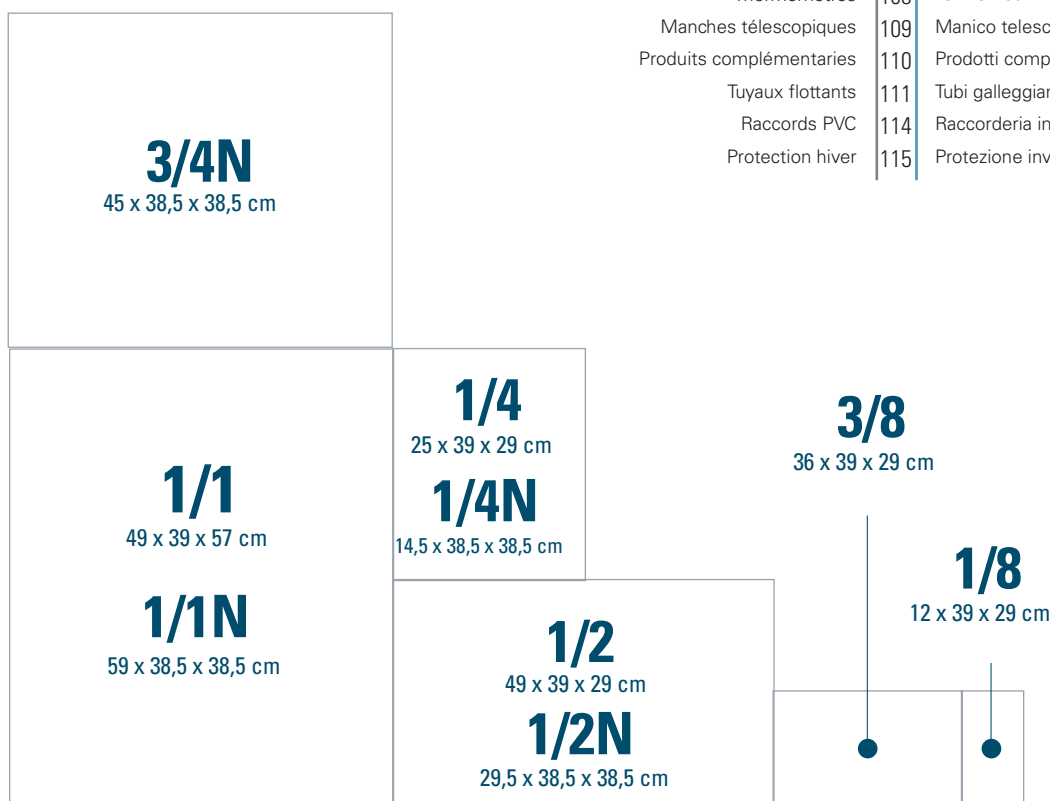

material de limpieza

cleaning material

ROBOTS ROBOTS ROBOTS ROBOTS



KAYAK FUTURE REMOTE CONTROL

REF. RKFA100CR



18 m

CBX PACK 1



8 4 1 2 0 8 1 2 5 3 3 1 2

El Kayak Future CR se adapta a todo tipo de piscinas hasta 120m² de superficie y limpia el fondo, las paredes y la línea de agua de su piscina.

Le robot Kayak Future RC convient pour tout type de piscine d'une superficie jusqu'à 120 m². Il nettoie le fond, les parois ainsi que la ligne d'eau.

The Kayak Future CR adapts to all types of pools measuring up to 120m² in surface area, cleaning the bottom, walls and water line.

Il Robot Kayak Future CR si adatta a tutti i tipi di piscine fino a 120m² di superficie, pulendo il fondo, le pareti e linea dell'acqua.

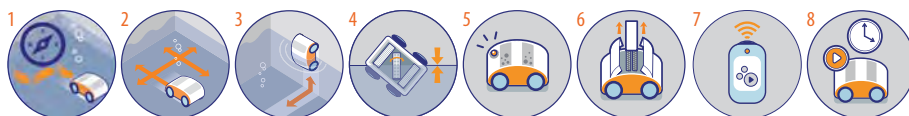

KAYAK FUTURE

REF. RKFA100



18 m

CBX PACK 1



8 4 1 2 0 8 1 2 5 0 8 4 7

El Kayak Future se adapta a todo tipo de piscinas hasta 120m² de superficie y limpia el fondo, las paredes y la línea de agua de su piscina.

Le robot Kayak Future convient pour tout type de piscine d'une superficie jusqu'à 120 m². Il nettoie le fond, les parois ainsi que la ligne d'eau.

The Kayak Future adapts to all types of pools measuring up to 120m² in surface area, cleaning the bottom, walls and water line.

Il Robot Kayak Future si adatta a tutti i tipi di piscine fino a 120m² di superficie, pulendo il fondo, le pareti e linea dell'acqua.

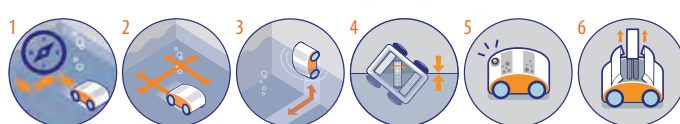

- GYRO:** Nuevo Sistema de Navegación Giroscópica que maximiza el ciclo de lavado y evita que el cable se enrede *New Gyroscopic Navigation System to improve navigation of the robot, maximize efficacy and prevent cable tangling* Nouveau système de navigation qui maximise le cycle de lavage et empêche câble enchevêtrement *Nuovo sistema di navigazione che massimizza il ciclo di lavaggio e previene l'aggrovigliamento del cavi*
- Aquasmart System:** Algoritmo patentado para limpiar la piscina en menos tiempo *Patented algorithm for covering a pool with less time* La fonction Aquasmart est un algorithme permettant un nettoyage plus rapide et plus efficace *Algoritmo certificato per pulire una piscina in minor tempo*
- Floor & Walls:** Limpia el suelo y las paredes de la piscina *Cleans the bottom and walls* Nettoie le fond et les parois de la piscine *Pulisce fondo e pareti della piscina*
- Water line:** Limpia la línea de flotación *Cleans the water line* Nettoyage de la ligne d'eau *Pulisce la linea dell'acqua*
- Filter check:** Indicador de filtro lleno mediante LED *Full filter LED indicator* Indicateur LED dans le transformateur indiquant que le filtre est plein *Indicatore filtro pieno mediante un LED luminoso*
- Top access:** Filtro de acceso superior *Top access filter* Filtre facile à nettoyer avec le système top access *Accesso al filtro nella parte superiore del robot*
- Remote Control:** Con mando a distancia *With easy remote control* Télécommande de contrôle *Telecomando a distanza*
- Timer:** Ciclo de limpieza programable *Programmable cleaning cycle* Cycle de nettoyage programmable *Ciclo di pulizia programmabile*

matériel de nettoyage materiale di pulizia



TRACK SALT 4x4

REF. R44SC

18 m

CBX PACK 1



El Track Salt 4x4 se adapta a todo tipo de piscinas hasta 90m² de superficie y limpia el fondo, las paredes y la línea de agua de su piscina. Con clorador salino incorporado.

The Track Salt 4x4 adapts to all types of pools measuring up to 90m² in surface area, cleaning the bottom, walls and water line. With chlorine generator.

Le robot Track Salt 4x4 convient pour tout type de piscine d'une superficie jusqu'à 90 m². Il nettoie le fond, les parois ainsi que la ligne d'eau. Avec un système d'électrolyse incorporé.

Il Robot Tracks Salt 4x4 si adatta a tutti i tipi di piscine fino a 90m² di superficie, pulendo il fondo, le pareti e linea dell'acqua. Dotato di clorinatore salino incorporato.



TRACK 4x4

REF. R44SP

18 m

CBX PACK 1



El Track 4x4 se adapta a todo tipo de piscinas hasta 90m² de superficie y limpia el fondo, las paredes y la línea de agua de su piscina.

The Track 4x4 adapts to all types of pools measuring up to 90m² in surface area, cleaning the bottom, walls and water line.

Le robot Track 4x4 convient pour tout type de piscine d'une superficie jusqu'à 90 m². Il nettoie le fond, les parois ainsi que la ligne d'eau.

Il Robot Tracks 4x4 si adatta a tutti i tipi di piscine fino a 90m² di superficie, pulendo il fondo, le pareti e linea dell'acqua.



1. **GYRO:** Nuevo Sistema de Navegación Giroscópica que maximiza el ciclo de lavado y evita que el cable se enrede *New Gyroscopic Navigation System to improve navigation of the robot, maximize efficacy and prevent cable tangling* Nouveau système de navigation qui maximise le cycle de lavage et empêche câble enchevêtrement Nuovo sistema di navigazione che massimizza il ciclo di lavaggio e previene l'agrovigliamento del cavo
2. **Floor & Walls:** Limpia el suelo y las paredes de la piscina *Cleans the floor and the wall of the pool* Nettoie le fond et les parois de la piscine Pulisce fondo e pareti della piscina
3. **Top access:** Filtro de acceso superior *Top access filter* Filtre facile à nettoyer avec le système top access Accesso al filtro nella parte superiore del robot
4. **Max scrubber:** Cepillo rotativo de gran velocidad *Fast moving brush* Brosse rotative de grande vitesse Spazzola rotante di grande velocità
5. **Easy view:** Ventana transparente para ver el filtro *Transparent window for seeing inside the filters* Système easy view pour avoir un aperçu sur le niveau de remplissage du filtre Finestrella trasparente per controllare meglio la situazione del filtro
6. **4x4:** Tecnología 4x4 patentada con un sólo motor de tracción *4x4 patented technology with only one drive motor* Système de traction 4x4 breveté avec 1 seul moteur pour une longévité accrue Tecnología 4x4 brevettata con un solo motore di trazione
7. **Plug&Play:** Conectar y listo para usar *Put the robot in the water and it's ready to clean* Prêt à fonctionner Una volta collegato è pronto per lavorare
8. **Easy clean:** Filtro fácil y rápido de limpiar *Filter that enables quick and easy cleaning* Facilité d'accès pour nettoyer le robot Filtro facile e rapido da pulire
9. **Light:** Robot ligero *Light robot* Robot léger Leggero
10. **Filter check:** Indicador de filtro lleno mediante LED *Full filter LED indicator* Indicateur LED dans le transformateur indiquant que le filtre est plein Indicatore filtro pieno mediante un LED luminoso
11. **Cl₂:** Con generador automático de cloro mediante sal *With automatic chlorine generator by salt* Avec générateur automatique du chlore avec le sel Genera automaticamente cloro mediante il sale

material de limpieza

cleaning material



KAYAK ADVENTURE

REF. RKA80

18 m

CBX PACK 1



El Kayak Adventure se adapta a todo tipo de piscinas hasta 100m² de superficie y limpia el fondo, las paredes y la línea de agua de su piscina.

Le robot Kayak Adventure convient pour tout type de piscine d'une superficie jusqu'à 100m². Il nettoie le fond, les parois ainsi que la ligne d'eau.

The Kayak Adventure adapts to all types of pools measuring up to 100m² in surface area, cleaning the bottom, walls and water line.

Il Robot Kayak Adventure si adatta a tutti i tipi di piscine fino a 100m² di superficie, pulendo il fondo, le pareti e linea dell'acqua.

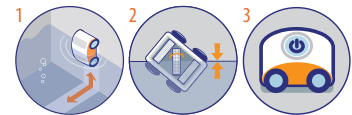

KAYAK ADVENTURE COMPACT

REF. RKA80C

15 m

CBX PACK 1



El Kayak Adventure Compact se adapta a todo tipo de piscinas hasta 100m² de superficie. Limpia el fondo y las paredes de su piscina.

Le robot Kayak Adventure Compact convient pour tout type de piscine d'une superficie jusqu'à 100m². Il nettoie le fond et les parois.

The Kayak Adventure Compact adapts to all types of pools measuring up to 100m² in surface area, cleaning the bottom and walls.

Il Robot Kayak Adventure Compact si adatta a tutti i tipi di piscine fino a 100m² di superficie, pulendo il fondo e le pareti.

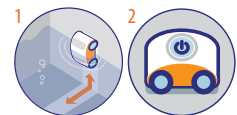

1. Floor & Walls: Limpia el suelo y las paredes de la piscina Cleans the bottom and walls Nettoie le fond et les parois de la piscine Pulisce fondo e pareti della piscina
2. Plug&Play: Conectar y listo para usar Put the robot in the water and it's ready to clean Prêt à fonctionner Una volta collegato è pronto per lavorare



KAYAK CLEVER
REF. RKC100J

12 m

CBX PACK 1



El Kayak Clever limpia el fondo fondo inclinado o plano de piscinas hasta 60m² de superficie.

The Kayak Clever adapts to all types of pools measuring up to 60m² in surface area, cleaning the bottoms whether they are flat or inclined.

Le robot Kayak Clever RKC100J convient pour tout type de piscine à fond plat ou pente douce d'une superficie jusqu'à 60m².

Il Robot Kayak Clever RKC100J si adatta a tutti i tipi di piscine fino a 60m² di superficie, pulendo il fondo in piano che inclinato.



KAYAK JET BLUE
REF. RKJ14

12 m

CBX PACK 1



El Kayak Jet Blue limpia el fondo fondo inclinado o plano de piscinas hasta 60m² de superficie.

The Kayak Jet Blue adapts to all types of pools measuring up to 60m² in surface area, cleaning the bottoms whether they are flat or inclined.

Le robot Kayak Jet Blue convient pour tout type de piscine à fond plat ou pente douce d'une superficie jusqu'à 60m².

Il Robot Kayak Jet Blue si adatta a tutti i tipi di piscine fino a 60m² di superficie, pulendo il fondo in piano che inclinato.



- 1. **Plug&Play:** Conectar y listo para usar Put the robot in the water and it's ready to clean Prêt à fonctionner Una volta collegato è pronto per lavorare
- 2. **Light:** Robot ligero Light robot Robot léger Leggero
- 3. **Top access:** Filtro de acceso superior Top access filter Filtre facile à nettoyer avec le système top access Accesso al filtro nella parte superiore del robot

material de limpieza

cleaning material

TRACK 1 REF. RT1S

18 m

CBX PACK 1



El Track 1 se adapta a todo tipo de piscinas hasta 120m² de superficie y limpia el suelo y la media caña de piscinas con borde curvo.

Le Track 1 s'adapte à toutes les piscines de jusqu'à 120m² de surface et il permet de nettoyer le fond et les bords arrondis des piscines.

The Track 1 adapts to all types of pools measuring up to 120m² in surface area, cleaning the floor and the half tube with curved edge.

Il Track 1 si adatta a tutte le tipologie di piscine fino a 120m² di superficie e pulisce il fondo e le stondature delle pareti delle piscine a bordo curvo.

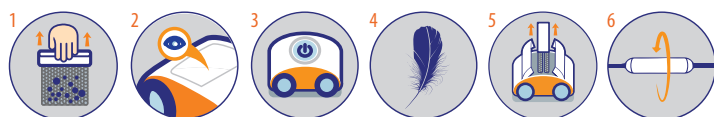

- 1. Easy clean:** Filtro fácil y rápido de limpiar Filter that enables quick and easy cleaning Facilité d'accès pour nettoyer le robot Filtro facile e rapido da pulire
- 2. Easy view:** Ventana transparente para ver el filtro Transparent window for seeing inside the filters Système easy view pour avoir un aperçu sur le niveau de remplissage du filtre Finestrella trasparente per controllare meglio la situazione del filtro
- 3. Plug&Play:** Conectar y listo para usar Put the robot in the water and it's ready to clean Prêt à fonctionner Una volta collegato è pronto per lavorare
- 4. Light:** Robot ligero Light robot Robot léger Leggero
- 5. Top access:** Filtro de acceso superior Top access filter Filtre facile à nettoyer avec le système top access Accesso al filtro nella parte superiore del robot
- 6. Anti-tangle system:** Sistema anti-enredo para un funcionamiento óptimo With anti-tangle system allowing optimal performance Système « anti-emmêlement » pour un rendement optimal Sistema "anti-impigliamento" che consente un'ottima resa

RECAMBIOS BOLSA FILTRANTE SPARE FILTRATION BAGS RECHARGES SAC POUR ROBOTS RICAMBI SACCO FILTRO



Recambio de bolsa filtrante textil - reutilizable - lavable

Recharge sac textile pour Robot Kayak - Réutilisable - Lavable

Spare filtration bag - 1 unit. Reusable - Washable

Busta per Robot Kayak - textil - scatola di 1 unità. Riutilizzabile - Lavabile

REF. 40683

PB pack 2



Sac jetable pour robot - carton de 3 pièces
Sac jetable pour robot - carton de 3 pièces

Non-returnable spare filtration bag - 3 units
Busta per robot usa e getta - scatola di 3 unità

REF. 40684

CBX pack 8



LIMPIAFONDOS ELÉCTRICOS ELECTRIC CLEANERS**NETTOYEUR DE FOND ÉLECTRIQUE PULITORE ELETTRICO PER FONDO PISCINA**

Los limpiafondos eléctricos son una solución cómoda y sencilla para la limpieza de la piscina. Son recargables, sin necesidad de cables y muy manejables debido a su tamaño y forma.

Les nettoyeurs de fond électriques sont une solution pratique et simple pour le nettoyage des piscines. Ils sont rechargeables, sans besoin de câbles et très faciles à utiliser en raison de leur taille et de leur forme.

Electric cleaners are a convenient and simple solution for cleaning the pool. They are rechargeable, wirelessly and very manageable because of its size and shape.

I pulitori elettrici per fondo piscina rappresentano una soluzione comoda e semplice per la pulizia della piscina. Sono ricaricabili, non necessitano di cavi e sono maneggevoli grazie alle loro dimensioni e alla forma.



8 4 1 2 0 8 1 2 6 3 2 9 8

ELECTRIC VAC

REF. VCB10

CBX PACK 1



Especialmente indicado para piscinas enterradas, limpia las escaleras y esquinas donde el limpiafondos automático no llega. Posee un depósito removible de gran capacidad e incorpora un filtro que retiene partículas de pequeño tamaño. Ligero y de fácil manejo. Recargable y sin cables: funciona con batería de litio recargable de 11,1 V. Posibilidad de uso con su propio asa o conectándolo a una pértiga.

Spécialement conçu pour les piscines enterrées. Il nettoie les escaliers et les angles, contrairement au nettoyeur de fond automatique. Il est muni d'un réservoir amovible de grande capacité et il incorpore un filtre qui retient les particules de petite taille. Léger et facile à manipuler. Rechargeable et sans câbles : il fonctionne avec un accumulateur lithium rechargeable de 11,1 V. Il peut être utilisé avec sa poignée ou bien connecté à une perche.

Especially indicated for embedded pools, cleans stairs and corners where automatic cleaners do not reach. It has a large capacity removable tank and includes a filter to retain small-size particles. Lightweight and easy to use. Rechargeable and without cables: operates with an 11.1 V lithium battery. Possibilities of use with its own handle or connected to a pole.

Particolarmente indicato per piscine interrate, pulisce le scalette e gli angoli che il pulitore automatico non riesce a raggiungere. È dotato di un capiente serbatoio removibile e di un filtro in grado di trattenere le particelle più piccole. Leggero e maneggevole. Ricaricabile e senza fili: funziona con batteria al litio ricaricabile da 11,1V.



8 4 1 2 0 8 1 2 6 5 3 1 5

POOL & SPA VAC

REF. ESPA

CBX PACK 1



Limpiafondos para piscinas y spas con mango. Recargable y sin cables. Posibilidad de uso con su propio mango o conectado a una pértiga. Ligero y manejable.

Nettoyeur de fonds pour piscines et spas avec manche. Rechargeable et sans câbles. Il peut être utilisé avec sa poignée ou bien connecté à une perche. Léger et facile à manipuler.

Pool and spa vac with handle. Rechargeable and without cables. Possibilities of use with its own handle or connected to a pole. Lightweight and easy to use.

Pulitore per fondo piscina e spa con manico. Ricaricabile e senza fili. Può essere utilizzato con il manico in dotazione o collegato a un'asta.

LIMPIAFONDOS AUTOMÁTICOS AUTOMATIC CLEANERS NETTOYEURS AUTOMATIQUES PULISCIFONDI AUTOMATICI

PROFESSIONAL VAC

REF. 19007

9,6m - Ø 38

CBX PACK 1



Limpiafondos automático de membrana. Limpia el fondo y las paredes de cualquier piscina. Funciona con sistemas de filtración de una potencia mínima de 0,2CV.

Nettoyeur automatique avec système unique de membrane. Nettoie le fond et les parois de la piscine. Il fonctionne avec des systèmes de filtration d'une puissance minimum de 0,2cv.

Automatic pool cleaner with membrane system. The Professional Vac cleans the bottom and walls of your pool. Works with 0,2 hp minimum.

Puliscifondo automatico con sistema a membrana. Il Professional Vac pulisce il fondo e le pareti della piscina. Funziona con sistemi di filtrazione che hanno una potenza minima di 0,2cv.



SILENCE VAC

REF. 90397

9,6m - Ø 38

CBX PACK 2



Limpiafondos automático más silencioso que los sistemas tradicionales de "martillo". Limpia el fondo y las paredes de su piscina. Funciona con sistemas de filtración de una potencia mínima de ½cv y máxima de 1½cv.

Nettoyeur automatique plus silencieux que les systèmes traditionnels à "marteau". Nettoie le fond et les parois de la piscine. Il fonctionne avec des systèmes de filtration d'une puissance minimum de ½cv et maximale de 1½cv.

Automatic pool cleaner which is quieter than the traditional "hammer" systems. The Silence Vac cleans the bottom and walls of your pool. Works with ½ hp minimum and 1½hp maximum power filtration systems.

Puliscifondo automatico più silenzioso dei sistemi tradizionali a "martello". Il Silence Vac pulisce il fondo e le pareti della piscina. Funziona con sistemi di filtrazione che hanno una potenza minima di ½cv e massima di 1½cv.



matériel de nettoyage materiale di pulizia



CLASSIC VAC

REF. 19001

8m - Ø 38

CBX PACK 1



Limpiafondos automático para piscinas enterradas y elevadas dotadas de un equipo de filtración con una bomba de potencia mínima de 3/4 cv.

Nettoyeur automatique de piscines enterrées et hors-sol équipé d'une filtration avec une pompe d'une puissance minimum de 3/4cv.

Automatic pool cleaner for in ground and above ground pools equipped with filtering equipment with a minimum power pump of 3/4 hp.

Puliscifondo automatico per piscine interrate e fuori terra dotate di un sistema di filtrazione con una potenza minima di 3/4 cv.



WIKI VAC

REF. 90399

6m - Ø 32

CBX PACK 2



Limpiafondos automático para piscinas autoportantes y elevadas. Funciona con equipos de filtración de baja potencia: a partir de 0,1cv. Dispone de un prefiltro exclusivo que permite proteger el cartucho y la filtración.

Nettoyeur automatique pour piscines autoportantes et hors-sol. Il fonctionne avec des filtrations de très faible puissance: à partir de 0,1cv minimum. Il dispose d'un préfiltre exclusif qui protège la cartouche et la filtration.

The automatic pool cleaner for inflatable or above ground pools. Works with low-power filtering equipment: ranging from 0.1hp. It has a unique pre-filter which protects the cartridge and filtration.

Puliscifondo per piscine autoportanti e fuoriterra. Funziona con un sistema di filtrazione a partire da 0,1 cv di potenza. È dotato di un prefiltro esclusivo che permette una maggior cura della cartuccia e della filtrazione.

SMALL CONFORT

REF. AR20682

6m - Ø 32

CBX PACK 4



Limpiafondos automático por aspiración. Se conecta directamente al skimmer y es compatible con bombas a partir de 1/3CV.

Nettoyeur de fond automatique par aspiration. Il se branche directement sur le skimmer et il est compatible avec des pompes à partir de 1/3 de CV.

Automatic suction pool cleaner that is directly connected to the skimmer. Compatible with pumps from 1/3HP.

Puliscifondo automatico ad aspirazione. Si collega direttamente allo skimmer ed è compatibile con pompe a partire da 1/3CV.



LIMPIAFONDOS DE ASPIRACIÓN MANUAL VACUUM CLEANERS NETTOYEURS ASPIRANTS PULITORE AD ASPIRAZIONE MANUALE

MEDIUM VAC

REF. AR20637

9m - Ø 32

CBX PACK 6



Kit de mantenimiento para piscinas autoportantes o elevadas. Contiene dos boquillas (una de ellas con cepillo).

Le Kit d'entretien pour piscines autoportantes ou hors-sol. Contient: un aspirateur de fond à aspiration manuelle qui inclut deux embouts.

Maintenance kit for inflatable or above ground pools. The pool cleaner includes: two suction nozzles, one with a brush.

Kit di mantenimento per piscine autoportanti o fuori terra. Contiene due aspiratori, uno con pennello



LITTLE VAC

REF. 08011A

5m - Ø 32

CBX PACK 6



Kit de mantenimiento para piscinas autoportantes o elevadas.

Le Kit d'entretien pour piscines autoportantes ou hors-sol.

Maintenance kit for inflatable or above ground pools.

Kit di mantenimento per piscine autoportanti o fuori terra.



LIMPIAFONDOS VENTURY VENTURY VACUUM ASPIRATEURS DE FOND VENTURY PULISCIFONDI VENTURY



REF. 08050

CS PACK 6



8 4 2 7 3 7 0 0 8 0 5 0 0

Kit piscina autoportante: analizador pH/Cl, cepillo, recogehojas de superficie, mango 1,20m (3 tramos) termómetro tubular, dosificador y jet vac ventury.

Kit spécial piscine autoportante: trousse d'analyse pH/Cl, brosse, époussette de surface, manche 1,20m (3 parties), thermomètre tubulaire, doseur pastilles rétractable and jet vac ventury.

Special inflatable pool kit: pH/chlorine test kit, brush, leaf net, tubular thermometer, 1,20m handle (3 sections), floating dispenser and ventury vacuum.

Kit speciale per piscina autoportante: analizzatore pH/Cl, spazzola, Raccoglitore di superficie, manico 1,20m (3 sezioni) termometro tubolare, dosatore e aspiratore jet vac ventury.



REF. PSV51

CBX PACK 6



8 4 1 2 0 8 1 2 5 0 1 3 7

Pool & Spa Vac: Limpiafondos manual con accesorios Incluye: recogedor superficie, boquilla ancha aspiración, cepillo acoplable, soporte para pared.

Pool & Spa Vac: Nettoyeur de fond manuel avec accessoires Il inclut: un ramasseur de surface, un bec large d'aspiration, une brosse et un support pour le mur.

Pool & Spa Vac: Limpiafondos manual con accesorios Include: rete foglie, Attachable brush + Wall bracket.

Pool & Spa Vac: Puliscifondo manuale con accessori Include: rete foglie, bocchetta di aspirazione, spazzola, staffa per muro.



REF. 90111

BX PACK 10



8 4 2 7 3 7 0 9 0 1 1 1 9

Limpiafondos Micro-Ventury.
Nettoyeur Micro-Venturi.

Micro-Ventury Vacuum.
Puliscifondi Micro-Ventury.



REF. Y15

CBX PACK 12



8 4 1 2 0 8 1 2 0 1 2 1 4

Kit limpiafondos Ventury+ pértiga.
Kit Aspirateur de fond Venturi + manche.

Ventury vacuum kit + handle.
Aspiratore Ventury+ pertica.



REF. Y10

CBX PACK 6



8 4 1 2 0 8 1 8 9 0 1 8 0

Limpiafondos Ventury+ pértiga
Aspirateur de fond Venturi + manche.

Ventury vacuum + handle.
Aspiratore Ventury+ pertica.

KITS LIMPIAFONDOS VACUUM CLEANER KITS

KIT NETTOYEUR ASPIRANTS KIT PULITORE FONDO AD ASPIRAZIONE

REF. AR20641

CBX PACK 2



Limpiafondos para pértiga + pértiga 3 secciones + recogedor de fondo + termómetro flotante + dosificador oval + cepillo para liner + manguera 6m + bote de tiras reactivas (tester)

Pack d'entretien comprenant: un nettoyeur de fond pour manche + perche 3 sections + epuisette de fond + thermomètre flottant + doseur ovale pour galets de 200gr + brosse pour liner + 6m tuyau + boîte de bandelettes de test (tester)

Bottom cleaner for pole + 3 section pole + leaf skimmer of bottom + floating thermometer + oval dispenser + brush for liner + 6m hose + can of reactive test strips (tester)

Puliscifondi + pertica 3 sezioni + raccogliore di fondo + termometro galleggiante + dosatore ovale + spazzola per liner + 6m tubo + confezione da strisce reattive (tester)



REF. AR2064

CBX PACK 4



Kit limpiafondos + pértiga 3,60m (3x1,20m) + manguera 6m

Kit nettoyeur + manche 3,60m (3x1,20m) + tuyau 6m

Vacuum head kit + handle 3,60m (3x1,20m) + 6m hose

Kit puliscifondo + pertica 3,60m (3x1,20m) + tubo 6m



REF. KMA05

CS PACK 6



Kit mantenimiento piscinas: analizador pH/Cl, cepillo 45 cm, recogehojas supercie, termómetro y limpiafondos

Kit de nettoyage pour piscines: analyse pH/Cl, brosse 45 cm, époussette de surface, thermomètre et balai manuel

Pool maintenance kit: pH/Cl Test kit, 45 cm Brush, leaf net, thermometer and Vacuum head

Kit di mantenimento per piscine: analizzatore ph/cl, spazzola 45 cm, raccogliore di supercie, termometro e puliscifondo



GAMA SUPERLUXE SUPERLUXE RANGE
GAMME SUPERLUXE GAMMA SUPERLUXE



Cepillo Luxe de 34 cm
 Brosse Luxe 34 cm

Luxe brush 34 cm
 Spazzola Luxe 34 cm

REF. LBP40

CB PACK 12



Cabezal Luxe aspirador
 manual flexible con cepillos
 Nettoyeur de fonds aspiration
 flexible Luxe avec de brosses

Flexible Luxe suction pool
 cleaner with brushes
 Puliscifondo aspirazione
 Luxe flessibile con spazzole

REF. LAMF10

CS PACK 6



Recogehojas de fondo
 Luxe con malla de nylon
 Épuisette de fond Luxe avec
 filet de nylon

Nylon net Luxe
 leaf rake
 Raccoglitore di fondo Luxe
 con la maglia di nylon

REF. LRF10

CB PACK 12



Recogehojas de superficie
 Luxe con malla de nylon
 Épuisette de surface Luxe avec
 filet de nylon

Nylon net Luxe
 leaf net
 Raccoglitore di superficie
 Luxe con la maglia di nylon

REF. LRS10

CB PACK 12



material de limpeza

cleaning material

RECOGEHOJAS LEAF NETS AND RAKES ÉPUISETTES RACCOGLITORI

Recogehojas fondo aluminio
Épuiette de fond aluminium

Aluminium Leaf rake
Raccogliore di fondo alluminio

REF. RHFAL

DIS 1/1N PACK 12



8 412081 237688



Recogehojas superficie aluminio
Épuiette de surface aluminium

Aluminium Leaf net
Raccogliore di superficie alluminio

REF. RHSAL

DIS 1/1N PACK 12



8 412081 237671



Recogehojas de superficie
+ mango telescópico
Épuiette de surface
+ manche télescopique

Leaf net
+ telescopic handle
Raccogliore di superficie
+ Manico telescopico

REF. 40031

CB PACK 12



8 427370 400315



Recogehojas de fondo
Gran Formato
Épuiette de fond
Grand Format

Big format
Leaf rake
Raccogliore di fondo
Gran formato

REF. 40032

DIS 1/1 PACK 12



8 427370 400322



Recogehojas de superficie
Gran Formato
Épuiette de surface
Grand Format

Big format
Leaf net
Raccogliore di superficie
Gran formato

REF. 40030

DIS 1/1 PACK 12



8 427370 400308



matériel de nettoyage materiale di pulizia

LIMPIAFONDOS MANUALES VACUUM HEADS BALAIS MANUELS PULISCIFONDO MANUALE



Limpiafondos triangular
rotativo
Balai triangulaire
rotatif

Triangular swivelling vac
head
Puliscifondo triangolare
rotante

REF. 40016

DIS 1/2N pack 4



Limpiafondos ovalado
rotativo con cepillos laterales
Balai oval rotatif avec brosses
latérales

Oval swivelling vac head
with lateral brushes
Puliscifondo ovale rotante
con spazzole laterali

REF. 40017

DIS 1/2N pack 6



Limpiafondos manual rotativo 8
ruedas con cepillos laterales
Balai manuel rotatif 8 roues
avec brosses latérales

Swivelling vacuum head 8
wheels with lateral brushes
Puliscifondo manuale con 8
ruote e spazzole laterali

REF. 40018

DIS 3/4N pack 12



Limpiafondos de aluminio
Balai en aluminium

Aluminium vac head
Alluminio puliscifondo

REF. 40022

BX PACK 6



Empuñadura clip Ø28mm
Poignée clip Ø28mm

Clip handle Ø28mm
Impugnatura clip Ø28mm

REF. 40092

DIS 1/4N pack 20



material de limpieza

cleaning material

DOSIFICADORES DISPENSERS DOSEURS DOSATORI

Combi Thermo-dosificador: Dosificador
Capacidad 1,5 Kg (pastillas de 20 a
500 g) + Termómetro + Visor de
consumo de producto

Combi Thermo-doseur: Doseur
Capacité 1,5 Kg (pastilles de 20 à
500 g) + Thermomètre + Témoin de
consommation de produit

Combi Thermo-dosifier: Dosifier
Capacity 1,5 kg (20 500 g tablets) +
Thermometer + Product
Consumption Viewer

Combi Thermo-Dosatore Capacità
1,5 kg (Tavolette da 20 a 500 g)
+ Termometro + Controllo livello
del prodotto

REF. 40070

DIS 1/2N PACK 5



8 4 2 7 3 7 0 4 0 0 7 0 4



Combi Thermo-dosificador: Dosificador
pastillas de 20 g + Termómetro +
Visor de consumo de producto

Combi Thermo-doseur: Doseur
pastilles de 20 g + Thermomètre +
Viseur de consommation de produit

Combi Thermo-dosifier: Dosifier
20g tablets + Thermometer +
Product Consumption Viewer

Combi Thermo-Dosatore Tavolette
da 20 g + Termometro + Controllo
livello del prodotto

REF. DCT20

DIS 1/2N PACK 36



8 4 1 2 0 8 1 2 4 1 4 6 3



Dosificador flotante.
Capacidad: 7 pastillas de 20 g
Doseur flottant.
Capacité 7 pastilles de 20 g

Floating dispenser.
Capacity: 7 tablets 20 g
Dosatore galleggiante.
Capacità 7 pastiglie da 20 g

REF. 40071

DIS 1/2N PACK 30



8 4 2 7 3 7 0 4 0 0 7 1 1



matériel de nettoyage materiale di pulizia

CEPILLOS BRUSHES BROSSES SPAZZOLE



Cepillo aluminio
Brosse aluminium

Aluminium brush
Spazzola alluminio

REF. 40046

DIS 3/4N pack 12



Cepillo aluminio para
eliminar algas
Brosse aluminium pour
éliminer les algues

Aluminium brush to
eliminate the algae
Spazzola alluminio
per eliminare le alghe

REF. CAA25

DIS 1/2N pack 32



Cepillo aspirante
Brosse aspirante

Vacuum brush
Spazzola con attacco per aspirare

REF. 40802

DIS 3/4N pack 10



Cepillo Gran Formato
Brosse Grand Format

Big Format brush
Spazzola Gran Formato

REF. 40041

DIS 3/4N pack 12



Cepillo línea de agua
Brosse ligne d'eau

Waterline brush
Spazzola per bordo acqua

REF. 40040

DIS 1/4N pack 12



Cepillo aspirador limpia-esquinas
Brosse aspirante d'angle

Vacuum brush
Spazzola aspiratutto per angoli

REF. 40806

DIS 1/4N pack 18



TERMÓMETROS THERMOMETERS
THERMOMÈTRES TERMOMETRI

Termómetro pez payaso
Thermomètre de poisson clown

Clown fish thermometer
Termometro pesce pagliaccio



REF. TBF20

BXL PACK 12



8 4 1 2 0 8 1 2 5 8 0 0 3

Termómetro bola
Thermomètre boule

Ball thermometer
Termometro a sfera



REF. 40055

CB pack 15



8 4 2 7 3 7 0 4 0 0 5 5 1

Termómetro boya
Thermomètre bouée

Buoy thermometer
Termometro galleggiante



REF. 40054

DIS 1/2N pack 10



8 4 2 7 3 7 0 4 0 0 5 4 4

Termómetro tubular flotante
Thermomètre flottant tubulaire

Tubular floating thermometer
Termometro galleggiante tubolare



REF. 40051

DIS 1/2N PACK 18



8 4 2 7 3 7 0 4 0 0 5 1 3

Termómetro "Big"
Doble lectura
"Big" Thermomètre
Double lecture

"Big" thermometer
Double reading
Termometro "Big"
Doppio lettura



REF. 40050

CS pack 12



8 4 2 7 3 7 0 4 0 0 5 0 6

matériel de nettoyage

materiale di pulizia



NEW

Box mixto de termómetros
pez versión standard y
versión Led.

Box mixte de thermomètres
poisson version standard et
version Led.

Mixed box with standard
and LED version fish
thermometers.

Contenitore con misto di
termometri a forma di pesce
in versione standard e led.

REF. BT474

BXL pack 1



MANGOS TELESCÓPICOS TELESCOPIC HANDLES MANCHES TÉLESCOPIQUES MANICO TELESCOPICO



Mango telescópico de aluminio
Manche télescopique argenté
3,60 m (3 x 1,20m)

Telescopic aluminium handle
Manico telescopico argentato

REF. 40014

BX pack 12



Mango telescópico de aluminio
Manche télescopique argenté
4,80 m (2 x 2,40m)

Telescopic aluminium handle
Manico telescopico argentato

REF. 40011

BX pack 10



Mango telescópico de aluminio
Manche télescopique argenté
3,60 m (2 x 1,80m)

Telescopic aluminium handle
Manico telescopico argentato

REF. 40010

BX pack 10



Mango telescópico de aluminio
Manche télescopique argenté
2,40 m (2 x 1,20m)

Telescopic aluminium handle
Manico telescopico argentato

REF. 40013

BX pack 20



material de limpieza

cleaning material

PRODUCTOS COMPLEMENTARIOS COMPLEMENTARY PRODUCTS
PRODUITS COMPLÉMENTAIRES PRODOTTI COMPLEMENTARI

Guante con esponja
para limpiar la línea de
flotación

Gant avec éponge pour le
nettoyage de la ligne de
flottaison sur le liner

Glove with cleaning
sponge for water line

Guanto in spugna
per pulire la linea di
galleggiamento

REF. GFL5

DIS pack 12



8 4 1 2 0 8 1 2 6 4 4 0 0



Esponjas mágicas para
la línea de flotación
4 unidades

Eponges magiques
nettoyant ligne d'eau
4 unités

Water line cleaner
magic sponges
4 units

Spugne magiche per la
linea di galleggiamento
4 unità

REF. PGL4

DIS pack 12



8 4 1 2 0 8 1 2 6 4 4 3 1



Esponjas absorbentes
de grasa
6 unidades

Eponges absorbentes
de residus gras
6 unités

Grease absorbing
sponge for skimmer
6 units

Spugne che assorbe e trattiene
le sostanze grasse
6 unità

REF. WFL6

DIS pack 12



8 4 1 2 0 8 1 2 6 4 4 2 4



Filtros de skimmer con velcro
10 unidades

Prefiltres jetables de skimmer
avec velcro
10 unités

Pre-filter fabric bag for use in
skimmer using velcro
10 units

Filtri di skimmer con velcro
10 unità

REF. FSK10

DIS pack 12



8 4 1 2 0 8 1 2 6 4 4 4 8



MANGUERAS VACUUM HOSES TUYAUX FLOTTANTS TUBI GALLEGGIANTI



Manguera para filtro 4m
con 2 terminales Ø32mm
Tuyau pour filtration 4m
avec 2 embouts Ø32mm

Filter hose 4m
with 2 cuffs Ø32mm
Tubo filtrante 4m
con 2 terminali da Ø32mm

REF. 40181

BX pack 1



Manguera para filtro 4m
con 2 terminales Ø38mm
Tuyau pour filtration 4m
avec 2 embouts Ø38mm

Filter hose 4m
with 2 cuffs Ø38mm
Tubo filtrante 4m
con 2 terminali da Ø38mm

REF. 40180

BX pack 1



Manguera limpiafondos 4m
con 2 terminales Ø38mm
Tuyau pour nettoyeur de fond 4m
avec 2 embouts soudés Ø38mm

Vacuum hose 4m
with 2 cuffs Ø38mm
Tubo puliscifondo 4m
con 2 terminali da Ø38mm

REF. AR212

BX pack 1



Manguera limpiafondos 6m
con 2 terminales Ø38mm
Tuyau pour nettoyeur de fond 6m
avec 2 embouts soudés Ø38mm

Vacuum hose 6m
with 2 cuffs Ø38mm
Tubo puliscifondo 6m
con 2 terminali da Ø38mm

REF. AR210

BX pack 1



Manguera limpiafondos 8m
con 2 terminales Ø38mm
Tuyau pour nettoyeur de fond 8m
avec 2 embouts soudés Ø38mm

Vacuum hose 8m
with 2 cuffs Ø38mm
Tubo puliscifondo 8m
con 2 terminali da Ø38mm

REF. 40001

BX pack 1



Manguera limpiafondos 10m
con 2 terminales Ø38mm
Tuyau pour nettoyeur de fond 10m
avec 2 embouts soudés Ø38mm

Vacuum hose 10m
with 2 cuffs Ø38mm
Tubo puliscifondo 10m
con 2 terminali da Ø38mm

REF. 40002

BX pack 1



Manguera limpiafondos 12m
con 2 terminales Ø38mm
Tuyau pour nettoyeur de fond 12m
avec 2 embouts soudés Ø38mm

Vacuum hose 12m
with 2 cuffs Ø38mm
Tubo puliscifondo 12m
con 2 terminali da Ø38mm

REF. 40003

BX pack 1



Manguera limpiafondos 15m
con 2 terminales Ø38mm
Tuyau pour nettoyeur de fond 15m
avec 2 embouts soudés Ø38mm

Vacuum hose 15m
with 2 cuffs Ø38mm
Tubo puliscifondo 15m
con 2 terminali da Ø38mm

REF. 40004

BX pack 1



material de limpieza

cleaning material

Manguera seccionable
36,5m - Ø38mm

Tuyau sectionnable
36,5m - Ø38mm

Sectionable hose
36,5m - Ø38mm

tubo sezionabile
36,5m - Ø38mm

REF. 90160

BX PACK 1



8 427370 901607

Manguera seccionable
36,5m - Ø32mm

Tuyau sectionnable
36,5m - Ø32mm

Sectionable hose
36,5m - Ø32mm

tubo sezionabile
36,5m - Ø32mm

REF. 90161

BX PACK 1



8 427370 901614



Kit mangueras filtración
Kit tuyaux pour épurateurs

2 (Ø38mm x 4,5m) + 1 (Ø38mm x 1,5m) + 1 (Ø38mm x 0,68m) + 1 (Ø38mm x 0,58m)
+ 1 (Ø38mm x 0,40m) + 7 abrazaderas / clamps / colliers / fascette

Filtration hoses kit
Kit tubi di filtraggio

REF. AR2100

BX PACK 1



8 412081 202518



Enrollador de mangueras
flotantes hasta 15m.
(Manguera no incluida)

Enrouleur de tuyaux
flottants. Jusqu'à 15m.
(Tuyau non inclus)

Vacuum hoses roller
maximum 15m.
(Vacuum hoses not included)

Avvolgitore per tubo
galleggiante fino a 15 m.
(Tubo non incluso)

REF. 90165

CBX PACK 1



8 427370 901652



Unión 2 mangueras flotantes
Ø38mm y 32mm

Liaison pour tuyaux flottants
Ø38mm et 32mm

2 vacuum hoses union
Ø38mm and 32mm

Raccordo per unire 2 tubi
Ø32mm - 38mm

REF. 40009

DIS PACK 12



8 427370 400094



Adaptador de mangueras 38/32mm
Adaptateur de tuyaux Ø38/32mm

38/32mm hose adapter
Adattatore per tubo 32/38mm

REF. 40095

BX PACK 20



8 427370 400957



matériel de nettoyage

materiale di pulizia



Quitavueltas para manguera Ø38mm
Raccord tournant pour tuyaux Ø38mm

Ø38mm hose adaptor with threaded connection
Adattatore per tubo Ø38mm

REF. 40091

BX PACK 30



Terminal manguera flotante - Ø38mm
Embout tuyau flottant - Ø38mm

Hose cuff - Ø38mm
Raccordo per tubo Ø38 mm

REF. 40012

BX PACK 20



2 conectores Ø38
+ 4 abrazaderas Ø38
2 manchons pour branchement
tuyaux Ø38 + 4 colliers Ø38

2 connectors Ø38
+ 4 clamps Ø38
2 raccordi Ø38
+ 4 fascette Ø38

REF. AR509

CS pack 10



2 conectores Ø38/32 +
4 abrazaderas Ø38/Ø32
2 manchons pour branchement
tuyaux Ø38/32 + 4 colliers Ø38/Ø32

2 connectors Ø38/32
+ 4 clamps Ø38/ Ø32
2 raccordi Ø38/32 +
4 fascette Ø38/Ø32

REF. AR511

CS pack 10



Manguera de conexión
68 cm - Ø38mm
Tuyau de jonction
68 cm - Ø38mm

Connection hose
68 cm - Ø38mm
Tubo di giunzione
68 cm - Ø38mm

REF. 60222

PB pack 10

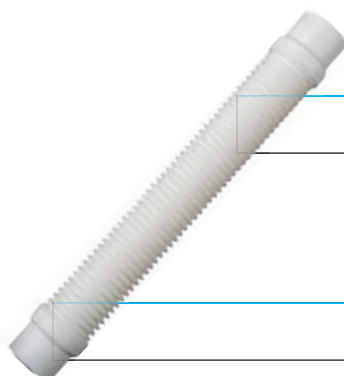

Manguera de conexión
58 cm - Ø38mm
Tuyau de jonction
58 cm - Ø38mm

Connection hose
58 cm - Ø38mm
Tubo di giunzione
58 cm - Ø38mm

REF. 60218

PB pack 10



Manguera de conexión
36 cm - Ø38mm
Tuyau de jonction
36 cm Ø38mm

Connection hose
36 cm - Ø38mm
Tubo di giunzione
36 cm - Ø38mm

REF. 60205

PB pack 10



RACORDERÍA PVC FITTINGS

RACCORDS PVC RACCORDERIA IN PVC



1	Enlace Ø 50 HXH PN16 Raccord PVC Ø 50 HXH PN16	PVC screw Ø 50 mm Raccordo Ø 50 HXH PN16	REF. 40537	BX PACK 15	8 427370 405372
	Enlace 3P. Ø 50 macho 1" 1/2 PN16 Raccord PVC en 3 parties Ø50 macho 1" 1/2 PN16	PVC 3 piece union solvent socket Ø50mm1"1/2 Raccordo 3P. Ø 50 maschio 1" 1/2 PN16	REF. 40538	BX PACK 20	8 427370 405389
2	Raccordo 3P. Ø 50 maschio 2" PN16 Raccord PVC en 3 parties Ø 50 macho 2" PN16	PVC 3 piece union solvent socket Ø 50mm 2" Raccordo 3P. Ø 50 maschio 2" PN16	REF. 40539	BX PACK 15	8 427370 405396
3	Válvula antirretorno Ø 50 PN16 Valve anti-retour Ø 50 PN16	Check valve Ø 50 mm Valvola ritorno Ø 50 PN16	REF. 40541	BX PACK 8	8 427370 405419
4	Válvula Ø 50 PN10 Valve anti-retour Ø 50 PN16	PVC ball valve Ø 50 mm Valvola Ø 50 PN10	REF. 40543	BX PACK 6	8 427370 405433
5	Racord curva Ø 50 90° PN16 - para encolar Valve anti-retour Ø 50 PN16	PVC elbow fitting 90° Ø 50 mm Valvola Ø 50 PN10	REF. 40555	BX PACK 10	8 427370 405556
6	Codo Ø 50 90° PN16 - para encolar Coude PVC à coller Ø 50 90° PN16	PVC 90° elbow solvent socket Ø 50 mm Gomito Ø 50 90° PN16 - da incollare	REF. 40590	BX PACK 30	8 427370 405907
	Codo Ø 50 45° PN16 Coude PVC Ø 50 45° PN16	PVC 45° elbow solvent socket Ø 50 mm Gomito Ø 50 45° PN16	REF. 40591	BX PACK 40	8 427370 405914
7	Te Ø 50 PN16 - para encolar Raccord en T à coller Ø 50 PN16	PVC-Tee 90° solvent socket Ø 50 mm Raccordo a T Ø 50 PN16 - da incollare	REF. 40592	BX PACK 24	8 427370 405921
8	Racord Ø 50 PN16 - para encolar Raccord PVC à coller Ø 50 PN16	PVC union solvent socket Ø 50 mm Raccordo Ø 50 PN16 - da incollare	REF. 40593	BX PACK 60	8 427370 405938
9	Válvula Ø50 PN10, manguito rosca macho Vanne Ø50 PN10 embout mal	Ball valve Ø50 mm Valvola Ø50 PN10, tubo filettato maschio	REF. 40646	BX PACK 8	8 427370 406461
10	Tubo PVC semirígido Ø 50, 25m Couronne PVC semi-rigide Ø 50, 25m	Semi-rigid PVC hose Ø 50 mm, 25m Tubo PVC semirigido Ø 50, 25m	REF. 40557	PB PACK 1	8 427370 405570
	Adhesivo para PVC 250 g Colle PVC 250gr	Blue Adhesive for flexible PVC pipes 250 g Adesivo per PVC 250 g	REF. 40553	BX PACK 12	8 427370 405532

matériel de nettoyage materiale di pulizia

PROTECCIÓN INVIERNO WINTER PROTECTION PROTECTION HIVER PROTEZIONE PER L'INVERNO



Flotador de hibernaje
Flotteur d'hivernage

Winterising fl oat
Galleggiante inverno

REF. 40580

BX PACK 10



Gizzmo - protección del skimmer
Gizzmo - protection du skimmer

Gizzmo - skimmer protection
Gizzmo - protezione per skimmer

REF. 40581

BX PACK 35



Tapón de invernaje 1,5"
Bouchon d'hivernage 1,5"

Winterising plug 1,5"
Tappo inverno 1.5"

REF. 40582

BX PACK 30



Tapón de invernaje 2"
Bouchon d'hivernage 2"

Winterising plug 2"
Tappo inverno 2"

REF. 40583

BX PACK 30





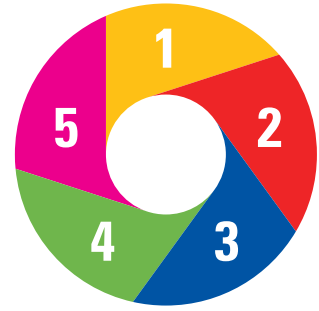

producto químico chemicals
produits d'entretien prodotti chimici



**MADE
IN
EU**

PASOS PARA CUIDAR DE SU PISCINA STEPS TO TAKE CARE OF YOUR SWIMMING POOL
ETAPES À SUIVRE POUR PRENDRE SOIN DE VOTRE PISCINE INDICAZIONI PER IL TRATTAMENTO DELLA PISCINA



Regular el pH
 pH regulation
 Réguler le pH
 Correttori di pH

Higienizar el agua
 Water sanitizing
 Higiéniser l'eau
 Igienizzazione dell'acqua

1

2

3a

3b

3c

¿Cómo?
How?
 ¿Comment?
 ¿Come?

Minorador de pH
 pH reduce
 Baisse le pH
 Riduttore di pH

Incrementador de PH
 pH increase
 Augmente le pH
 Incrementatore pH

Cloro choque
 Shock chlorine
 Chlore choc
 Cloro shock

Cloro lento
 Slow
 chloration
 Chlore lent
 Cloro lento

Bromo
 Bromine
 Brome
 Bromine

Oxígeno activo
 Active oxygen
 Oxygène actif
 Ossigeno attivo

¿Para qué?
Why?
 ¿Pourquoi?
 ¿Perché?

Obtener un pH entre 7,2 y 7,6
 To have a pH value between 7,2 and 7,6
 Obtenir un pH entre 7,2 et 7,6
 Stabilizzare pH tra 7.2 e 7.6

Higienizar rápidamente y destruir los organismos, hongos y bacterias
 To sanitize quickly and to eliminate all the organisms and bacteria
 Higiéniser rapidement et détruire les organismes, champignons et bactéries
 igienizzare rapidamente e distruggere tutti gli organismi, funghi e batteri

Desinfectar permanentemente
 To have a permanent disinfection
 Désinfecter en permanence
 Disinfezione permanente

¿Cuándo?
When?
 ¿Quando?
 ¿Quando?

A diario
 Daily
 Chaque jour
 Trattamento quotidiano

Al inicio de temporada / Después de condiciones climáticas extremas / Uso intensivo de la piscina
 At the beginning of the swim season / After bad weather conditions / High use level
 Début de saison / Après des conditions climatiques extrêmes / Usage intensif de la piscine
 Inizio stagione / Dopo che si sono verificate cambiamenti climatici molto forti / Uso intensivo della piscina

A diario
 Daily
 Chaque jour
 Trattamento quotidiano

Resultado
Result
 Résultat
 Risultato

pH ideal para la piel y los ojos. Instalaciones en perfecto estado
 Ideal pH for skin and eyes. Good conditions equipment
 pH idéal pour la peau et les yeux. Installations en parfait état
 pH stabile non genera fastidi ad occhi e alla pelle

Agua limpia y libre de posibles contagios
 Clean water without contagious risk
 Eau propre et libre de possibles contagions
 Acqua pulita e libera da ogni impurità

Agua limpia y libre de posibles contagios
 Clean water without contagious risk
 Eau propre et libre de possibles contagions
 Acqua pulita e libera da ogni impurità

produits d'entretien [prodotti chimici]



Tratamiento antialgas
Anti-algae treatment
Traitement anti-algues
Trattamento antialghe

Floculación
Flocculation
Floculation
Floculante

Complet 4
Actions

Total 5 Actions

Total 10 Actions

4

5

Antialgas concentrado
Concentrated algaecide
Anti-algues concentré
Antialghe concentrato

Antialgas Extra
Extra anti-algae
Anti-algues Extra
Antialghe extra

Floculante
Flocculant
Floculant
Floculante

Fórmula innovadora que permite en una sola aplicación, eliminar bacterias, virus y microorganismos en general

Thanks to its new formula, you can eliminate bacteria, virus and microorganisms

Formule innovatrice, il permet avec une

seule application, d'éliminer bactéries, virus et microorganismes en général

Formula innovativa che permette in una sola applicazione

eliminare i batteri, virus e microorganismi in generale

Prevenir la aparición de algas
To avoid algae apparition
Prevenir l'apparition
des algues
Prevenire la comparsa delle
alghè

Eliminar las algas existentes
To eliminate the algae
Éliminer les algues existantes
Eliminare la presenza di alghè

Eliminar las partículas
en suspensión
To eliminate particles
in suspension
Éliminer les particules
en suspension
Elimina le impurità

4 funciones:
- Cloro
- Antialgas
- Estabilizante
- Floculante

4 functions:
- Chlorine
- Antialgae
- Stabiliser
- Flocculant

4 fonctions:
- Chlore
- Anti-algues
- Stabilisant
- Floculant

4 funzioni:
- Cloro
- Antialghe
- Stabilizzante
- Floculante

5 funciones
- Cloro
- Antialgas
- Estabilizante
- Floculante
Anticalcáreo

5 functions:
- Chlorine
- Antialgae
- Stabiliser
- Flocculant
- Antilime

5 fonctions:
- Chlore
- Anti-algues
- Stabilisant
- Floculant
- Anticalcaire

5 funzioni:
- Cloro
- Antialghe
- Stabilizzante
- Floculante
- Anticalcare

10 funciones:
- Bactericida - Regulador de pH
- Floculante - Estabilizante de cloro
- Coagulante - Anticalcáreo
- Algicida - Virucida
- Algicida - Fungicida

10 functions:
- Germicide - pH regulator
- Flocculent - Chlorine stabilizer
- Coagulant - Anti-Limescale Agent
- Algicide - Virucide
- Algistatic - Fungicide

10 fonctions:
- Bactéricide - Régulateur de pH
- Floculant - Stabilisant de chlore
- Coagulant - Anticalcaire
- Algicide - Virucide
- Algistatique - Fongicide

10 funzioni:
- Battericida - Regolatore de pH
- Floculante - Stabilizzante del cloro
- Coagulante - Anticalcare
- Alghicida - Virucida
- Alghistatico - Funghicida

Según convenga
Depending on water quality
Selon convenance
Quando necessario

Semanalmente
Weekly
Chaque semaine
Settimanalmente

Agua sin algas
Water without algae

Agua cristalina
Crystalline water

Cálculo de volumen de agua

Para un correcto suministro del producto químico, es importante calcular el volumen de agua de la piscina.

Calculate the pool water volume

It is important to calculate the pool water volume to do a correct chemical treatment.

Calcul de volume d'eau

Pour un bon dosage du produit chimique, il est nécessaire de calculer le volume d'eau de la piscine.

Calcolo del volume d'acqua

Per un corretto dosaggio del prodotto chimico è importante calcolare il volume d'acqua di una piscina.

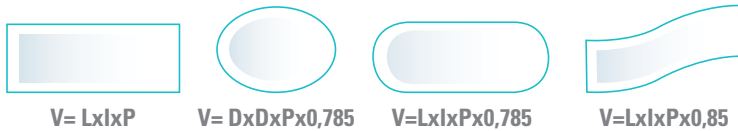

V	Volumen en m ³	Volume in m ³	Volume en m ³	Volume in m ³
L	Longitud en m	Length in m	Longueur en m	Lunghezza in m
I	Anchura en m	Width in m	Largeur en m	Larghezza in m
D	Diámetro en m	Diameter in m	Diamètre en m	Diametro in m
P	Profundidad en m	Depth in m	Profondeur en m	Profondità media in m

Ejemplo Example Exemple Esempio

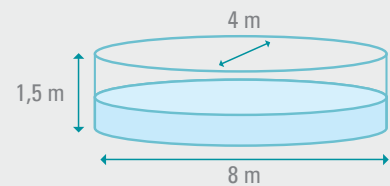

$$1,5 \text{ m} \times 8 \times 4 \times 0,785 = 37,68 \text{ m}^3$$

LEYENDA LEGEND LÉGENDE LEGENDA



REGULADORES DE PH PH REGULATORS
RÉGULATEURS DE PH CORRETTORI DI PH

El pH indica la acidez o la basicidad del agua. En una piscina debe mantenerse ajustado entre los valores 7.2 y 7.6, ya que además de conservar las instalaciones en óptimas condiciones, es el ideal para la piel y los ojos de los bañistas.

pH shows if water is acid or basic. Pool water pH must be between 7.2 and 7.6, because it helps to conserve the equipment in good conditions and it is ideal for swimmer eyes and skin.

Le pH indique l'acidité ou la basicité de l'eau. L'eau de la piscine doit se maintenir entre les taux 7.2 et 7.6, car il aide à mieux conserver les installations et est l' idéal pour la peau et les yeux des baigneurs.

Il pH indica la acidità e la basicità dell' acqua. In una piscina il valore di riferimento deve essere sempre tra 7.2 e 7.6, dal momento che, oltre a favorire il trattamento chimico che viene effettuato, è il valore ideale affinché la pelle e gli occhi dei bagnanti non si irritino.

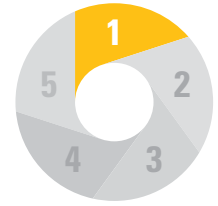

INCREMENTADOR DE pH pH INCREASE
AUGMENTE LE pH INCREMENTATORE pH

pH PLUS

GRANULADO GRANULES GRANULÉS GRANULATO



Ref. **76018** 1 Kg pack 12



Ref. **76001** 5 Kg pack 4



Incrementador de pH: para aumentar y estabilizar el pH
 pH increase: to increase and stabilize pH
 Augmente le pH: pour augmenter et stabiliser le pH
 Per aumentare e stabilizzare il pH

MINORADOR DE pH pH REDUCE
BAISSE LE pH RIDUTTORE pH

pH MINUS

GRANULADO GRANULES GRANULÉS GRANULATO



Ref. **76019** 1,5 Kg pack 12



Ref. **76002** 5 Kg pack 4



Minorador de pH: para bajar y estabilizar el pH
 pH reduce: to lower and stabilize pH
 Baisse le pH: pour baisser et stabiliser le pH
 Per abbassare e stabilizzare il pH

7.2

7.6



use pH+

use pH-

Higienizantes Sanitizings Hygiénisation Igienizzanti

Para poder tener un agua transparente y en definitiva libre de posibles contagios, es imprescindible que ésta sea higienizada regularmente. Los productos higienizantes pueden ser de diversos tipos, siendo los más comunes los productos clorados, aunque también existen otras soluciones alternativas, igualmente con un elevado poder higienizante, como el bromo o el oxígeno activo.

In order to have clear water without contagious danger, it is necessary to treat it regularly. There exist several kind of sanitizings, whose most common is chlorine. Other solutions like bromine or oxygen have also a high sanitizing action.

CLORO CHOQUE SHOCK CHLORINE CHLORE CHOC CLORO SHOCK

El Cloro Choque permite destruir rápida y eficazmente todos los organismos, hongos y bacterias. Conviene realizar una cloración de choque: Al inicio de la temporada de baño / Después de condiciones climáticas extremas / En caso de uso intensivo de la piscina.

It eliminates quickly all the organisms and bacteria. It is necessary to do a Shock chloration: At the beginning of the swim season / After bad weather conditions / High use level.

Le Chlore Choc permet de détruire rapidement tous les organismes, champignons et bactéries. Il convient d'effectuer une chloration choc: Au début de la saison de baignade / Après des conditions climatiques extrêmes / En cas d'usage intensif de la piscine.

Permette di eliminare rapidamente ed efficacemente tutti gli organismi, funghi e batteri. È utile usare questo tipo di prodotto: All'inizio della stagione / Dopo condizioni climatiche estreme / In caso di un uso intensivo della piscina.

CLORCHOC

PASTILLAS 20g 20g TABLETS PASTILLES 20g PASTIGLIE 20g



Ref. 76020

1 Kg

pack 12



Ref. 76003

5 Kg

pack 4



Con un 50% de cloro activo mínimo (tricloro). Disolución instantánea.
Minimum 50% active chlorine (trichlorine). Instant dissolution.
50% chlore actif minimum (trichlore). Dissolution instantanée.
Con un minimo del 50% di cloro attivo (tricloro). Dissoluzione istantanea.

GRANULADO GRANULES GRANULÉS GRANULATO



Ref. 76021

1 Kg

pack 12



Ref. 76004

5 Kg

pack 4



Con un 55% de cloro activo mínimo. Disolución rápida.
Minimum 55% active chlorine. Quick dissolution.
55% chlore actif minimum. Dissolution rapide.
Con un 55% di cloro minimo attivo. Dissoluzione rapida.

Pour avoir une eau transparente et libre de bactéries, il est indispensable que celle-ci soit traitée régulièrement. Il existe plusieurs sortes de hygiénisants, le chlore étant le plus connu. Également, il y a d'autres solutions alternatives avec un haut pouvoir hygiénisant, comme le brome ou l'oxygène actif.

Per avere un' acqua pulita e libera da ogni possibile contagio è indispensabile che quest'ultima sia igienizzata regolarmente. Gli igienizzanti più comuni sono a base di cloro, ma possono essere di diverso tipo dal momento che, esistono altre soluzioni alternative, come per esempio l'ossigeno attivo e il bromo.



CLORO LENTO TRICHLORINE CHLORE LENT CLORO LENTO

Para conseguir una higienización preventiva y continua del agua, es necesario mantener una tasa de cloración libre. Por ello, conviene efectuar una cloración permanente o "cloración lenta".

To have a preventive and continue sanitizing, it is necessary to keep a free chloration value. For this reason, people must do a permanent chloration or a "slow chloration".

Pour avoir une hygiénisation préventive et continue, il est nécessaire de maintenir un taux de chloration libre. Pour cette raison, il faut effectuer une chloration permanente ou «chloration lente».

Per ottenere una igienizzazione preventiva e continua dell'acqua, è necessario mantenere un valore di cloro "libero". Per questo è bene effettuare una clorazione continua o una "clorazione lenta".

CLORLENT

TABLETAS 250g 250g TABLETS GALETS 250g PASTIGLIE 250g



Ref. 76022

1 Kg

pack 12



Ref. 76005

5 Kg

pack 4



GRANULADO GRANULES GRANULÉS GRANULATO



Ref. 76023

1 Kg

pack 12



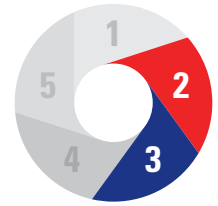

BROMO BROMINE BROME BROMO

Diferencias respecto al cloro: menos olor, no daña la piel ni el cabello. Más eficacia en las aguas calientes y/o calcáreas.

Differences compared to chlorine: less smell, does not dry out skin and hair. More efficient in hot and/or calcareous water.

Différences par rapport au chlore: moins d'odeur, ne dessèche pas la peau ni les cheveux. Plus efficace dans les eaux chaudes et/ou calcaires.

Differenze rispetto al cloro: meno odore, non danneggia la pelle né i capelli. Più effi cace con l'acqua molto calda e/o calcarea.



BROM'LENT

PASTILLAS 20g 20g TABLETS PASTILLES 20g PASTIGLIE 20g



Ref. 76025

1 Kg

pack 12



Ref. 76024

5 Kg

pack 4



BROM CHOC

GRANULADO GRANULES GRANULÉS GRANULATO



Ref. 76026

5 Kg

pack 4



BROM MULTIACTIONS

PASTILLAS 20g 20g TABLETS PASTILLES 20g PASTIGLIE 20g



Ref. 76027

5 Kg

pack 4



Bromo multi-Acciones
Bromine multi-Actions
Brome multi-Actions
Bromo multi funzioni

OXÍGENO ACTIVO ACTIVE OXYGEN OXYGÈNE ACTIF OSSIGENO ATTIVO

Ofrece muchas ventajas, ya que proporciona una desinfección muy eficaz y a diferencia del cloro, no provoca irritaciones oculares ni desprende olores desagradables. Producto que necesita de un dosificador.

This product offers a lot of advantages. It disinfects pool water and contrary to chlorine, it does not cause eye irritation neither and bad smells. This product needs a dispenser.

Ce produit offre beaucoup d'avantages par rapport au chlore, car il ne provoque aucune irritation oculaire, ôte les mauvaises odeurs et en même temps fait une désinfection très efficace. Il a besoin d'un doseur. Offre molti vantaggi, dal momento che sviluppa una igienizzazione molto efficace e, a differenza del cloro, non irrita gli occhi e non ha un odore sgradevole. E' un prodotto che necessita del dosatore.

ACTI OXY

LÍQUIDO LIQUID LIQUIDE LIQUIDO



Ref. 76028

5 L

pack 4



OXY CHOC

LÍQUIDO LIQUID LIQUIDE LIQUIDO



Ref. 76030

5 L

pack 4



OXY LENT

PASTILLAS 20g 20g TABLETS PASTILLES 20g PASTIGLIE 20g



Ref. 76029

12Kg

pack 12



Multifunciones Multiactions
Multi-actions Multi funzioni

Se trata de un producto revolucionario, ya que gracias a su fórmula innovadora permite en una sola aplicación, eliminar las bacterias, virus y microorganismos en general, evitar el desarrollo de algas, al mismo tiempo que mantiene transparente y cristalina el agua.

Revolution product: Thanks to its new formula, allows in a single application eliminate bacteria, virus and micro organisms, avoid algae and have clear and crystalline water.

Il s'agit d'un produit révolutionnaire. Grâce à sa formule innovatrice, il permet avec une seule application, d'éliminer les bactéries, virus et micro organismes en général, d'éviter l'apparition d'algues, ainsi que de conserver l'eau transparente et cristalline.

Si tratta di un prodotto rivoluzionario proprio perché, grazie alla sua formula innovatrice, permette, in una sola applicazione, di eliminare i batteri, virus e tutti i microrganismi evitando il proliferare di alghe, mantenendo allo stesso tempo l'acqua trasparente e cristallina.

COMPLET 4 ACCIONES COMPLET 4 ACTIONS
COMPLET 4 AZIONI

Cloro + Antialgas + Estabilizante + Floculante
Chlorine + Antialgae + Stabiliser + Flocculant
Chlore + Anti-algues + Stabilisant + Flocculant
Cloro + Antialghe + Stabilizzante + Flocculante

COMPLET 4 ACTIONS

1 BLOQUE 500g 500g 1 BLOCK 1 BLOC 500g PASTIGLIA 500g 1



Ref. **76035** 0,5Kg pack 48 8 4 2 7 3 7 0 7 6 0 3 5 8

TABLETAS 250g 250g TABLETS GALETS 250g PASTIGLIE 250g



Ref. **76007** 1 Kg pack 12 8 4 2 7 3 7 0 7 6 0 0 7 5



Ref. **76006** 5 Kg pack 4 8 4 2 7 3 7 0 7 6 0 0 6 8



Ref. **76055** 5 Kg pack 42 8 4 2 7 3 7 0 7 6 0 5 5 6



Ref. **76031** 10 Kg pack 2 8 4 2 7 3 7 0 7 6 0 3 1 0

PASTILLAS 20g 20g TABLETS PASTILLES 20g PASTIGLIE 20g



Ref. **76032** 1 Kg pack 12 8 4 2 7 3 7 0 7 6 0 3 2 7



Ref. **76033** 5 Kg pack 4 8 4 2 7 3 7 0 7 6 0 3 3 4

GRANULADO GRANULES GRANULÉS GRANULATO



Ref. **76034** 5 Kg pack 4 8 4 2 7 3 7 0 7 6 0 3 4 1



COMPLET 4 ACTIONS- SPECIAL LINER

TABLETAS 250g 250g TABLETS GALETS 250g PASTIGLIE 250g



Ref. **76039** 1 Kg pack 12 8 4 2 7 3 7 0 7 6 0 3 9 6



Ref. **76012** 5 Kg pack 4 8 4 2 7 3 7 0 7 6 0 1 2 9

Sin sulfato de cobre
Without copper sulphate.
Sans sulfate de cuivre
Senza solfato di rame



TOTAL 5 ACCIONES TOTAL 5 ACTIONS
TOTAL 5 ACTIONS TOTAL 5 AZIONI

Cloro + Antialgas + Estabilizante + Flocculante + Antical
Chlorine + Antialgae + Stabiliser + Flocculant + Anti lime
Chlore + Anti-algues + Stabilisant + Flocculant + Anti-calcaire
Cloro + Antialghe + Stabilizzante + Flocculante + Anticalcare

TOTAL 5 ACTIONS

TABLETAS 250g 250g TABLETS GALETS 250g PASTIGLIE 250g



Ref. **76036** 5 Kg pack 4 8 4 2 7 3 7 0 7 6 0 3 6 5



Ref. **76037** 10 Kg pack 2 8 4 2 7 3 7 0 7 6 0 3 7 2



MULTIFUNCIONES BICAPA
TWO-LAYER MULTIACTIONS
MULTI-ACTIONS BICOUCHE
MULTI FUNZIONI DOPPIO STRATO

Cloro multifunción + choque
Multiactions + shock chlorine
Chlore multi-actions + choc
Cloro multi funzioni + shock

MULTIACTIONS + CHOC

TABLETAS 250g 250g TABLETS GALETS 250g PASTIGLIE 250g



Ref. **76040** 1 Kg pack 6 8 4 2 7 3 7 0 7 6 0 4 0 2



TOTAL 10 ACCIONES TOTAL 10 ACTIONS
TOTAL 10 ACTIONS TOTAL 10 AZIONI

Desinfectante + Bactericida + Flocculante + Coagulante + Algicida + Algistático + Regulador de pH + Estabilizante de cloro + Anticalcáreo + Virucida + Fungicida
Disinfectant+ Germicide + Flocculent + Coagulant + Algicide + Algistatic + pH regulator + Chlorine stabilizer + Anti-Limescale Agent + Virucide+ Fungicide
Désinfectant + Bactéricide + Flocculant + Coagulant + Algicide + Algistatique + Régulateur de pH + Stabilisant de chlore + Anticalcaire + Virucide + Fongicide
Disinfettante + Battericida + Flocculante + Coagulante + Algicida + Alghistatico + Regolatore del pH + Stabilizzante del cloro + Anticalcare + Virucida + Funghicida

TOTAL 10 ACTIONS

TABLETAS 250g 250g TABLETS GALETS 250g PASTIGLIE 250g



Ref. **76038** 5 Kg pack 4 8 4 2 7 3 7 0 7 6 0 3 8 9

Tratamiento antialgas Anti-algae treatment
Traitement anti-algues Trattamento antialghe



ANTIALGAS CONCENTRADO CONCENTRATED
ANTI ALGAE ANTI-ALGUES CONCENTRÉ
ANTIALGHE CONCENTRATO

ANTIALG COMPACT

NO ESPUMANTE NO FOAMING NON MOUSSANT NON IN SCHIUMA



Ref. **76013** 1 L pack 12 8 4 2 7 3 7 0 7 6 0 1 3 6



Ref. **76014** 0,5 L pack 24 8 4 2 7 3 7 0 7 6 0 1 4 3

ESPUMANTE FOAMING MOUSSANT in schiuma



Ref. **76015** 1 L pack 12 8 4 2 7 3 7 0 7 6 0 1 5 0



Ref. **76016** 0,5 L pack 24 8 4 2 7 3 7 0 7 6 0 1 6 7

ANTIALG

LÍQUIDO LIQUID LIQUIDE LIQUIDO



Ref. **76009** 1 L pack 12 8 4 2 7 3 7 0 7 6 0 0 9 9



Ref. **76008** 5 L pack 4 8 4 2 7 3 7 0 7 6 0 0 8 2



Ref. **76056** 5 L pack 48 8 4 2 7 3 7 0 7 6 0 5 6 3

Para prevenir la aparición de algas.
 To prevent the appearance of algae
 Pour prévenir l'apparition d'algues.
 Per prevenire la comparsa delle alghe.

Las algas son organismos vegetales unicelulares que pueden desarrollarse y multiplicarse rápidamente en el agua, sobre todo cuando su temperatura es templada.

Algae are vegetal unicellular organisms that can quickly develop and multiply themselves in the water, specially when the temperature of the water is warm.

Les algues sont des organismes végétaux unicellulaires qui peuvent apparaître et se multiplier très rapidement dans l'eau, surtout quand la température de l'eau est tempérée.

Le alghe sono organismi vegetali unicellulari che possono svilupparsi e moltiplicarsi soprattutto quando la temperatura dell'acqua è abbastanza calda.

ANTIALGAS EXTRA EXTRA ANTI ALGAE
ANTI-ALGUES EXTRA ANTI ALGHE EXTRA

ANTIALG XTRA

LÍQUIDO LIQUID LIQUIDE LIQUIDO



Ref. **76041** 1 L pack 12 8 4 2 7 3 7 0 7 6 0 4 1 9



Ref. **76042** 5 L pack 4 8 4 2 7 3 7 0 7 6 0 4 2 6

3 acciones. Extra: para eliminar todas las algas.

3 actions. Extra: to eliminate the algae.

3 actions. Extra: pour éliminer la totalité des algues.

3 azioni. Extra. Per eliminare tutti i tipi di alghe.

STOP AGUAS VERDES STOP GREEN WATERS
STOP EAUX VERTES STOP ACQUA VERDI

STOP EAUX VERTES

LÍQUIDO LIQUID LIQUIDE LIQUIDO



Ref. **76043** 5 L pack 4 8 4 2 7 3 7 0 7 6 0 4 3 3

Oxígeno activo: acción sin cloro

Active oxygen: without chlorine

Oxygène actif: action sans chlore

Ossigeno attivo: azione senza cloro

Floculante Flocculant
Floculant Flocculante

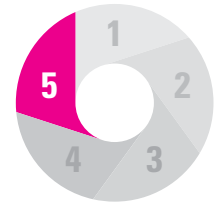

La floculación permite obtener un agua cristalina. Existen dos tipos de floculación: la que se realiza dentro del filtro y la floculación dentro del vaso. La primera permite aumentar la fineza de filtración y eliminar de esta manera las partículas más finas. Ésta se efectúa gracias a los cartuchos floculantes (incompatibles con filtros de cartucho) colocados en el cesto del skimmer. La segunda permite agrupar entre ellas las impurezas que no pueden ser filtradas individualmente y que son el origen de un agua turbia. Esta operación se efectúa con el floculante líquido.

Flocculation allows to obtain a crystalline water. There are two kind of flocculation: inside the filter and in the pool. With the first one we increase the fineness of filtration in order to eliminate smaller particles. For this process we introduce flocculants cartridges (incompatible with cartridge filters) in the skimmer basket. The second one helps us to group all the impurities that are the beginning of brown water thanks to liquid flocculant. La flocculation permet d'obtenir une eau cristalline. Il y a deux types de flocculation: celle qui se fait dans le filtre et la flocculation dans le bassin. La première permet d'augmenter la finesse de filtration et d'éliminer de cette façon les particules plus fines. S'effectue grâce aux cartouches floculantes (incompatibles avec les filtres à cartouche) dans le panier du skimmer. La deuxième permet de regrouper entre elles les impuretés qui ne peuvent pas être filtrées et qui sont l'origine des eaux troubles. Cette opération se fait avec le floculant liquide.

La flocculazione permette di ottenere un'acqua cristallina. Esistono due tipi di flocculazione: quella che si realizza all'interno del filtro e quella diluendo il prodotto in un contenitore. La prima permette di migliorare la filtrazione ed eliminare le particelle più fini e si effettua grazie alle cartucce floculanti (incompatibili con i filtri a cartuccia) poste dentro il cesto dello skimmer. La seconda permette di raggruppare tra loro le impurità che non possono essere filtrate individualmente e che sono la causa dell'acqua torbida. Questo procedimento si effettua con il floculante liquido.

TABLETAS FLOCULANTES FLOCCULANT TABLETS
TABLETES DE FLOCCULANT FLOCCULANTE IN PASTIGLIE

SUPER FLOCULANT

10 TABLETAS 20g 20g 10 TABLETS 10 GALETS 20g 10 PASTIGLIE 20g



Tabletas de floculante superconcentradas.
Super-concentrated flocculant tablets.
Tablettes de floculant super concentrées.
Flocculante in pastiglie superconcentrate.



FLOCULANTE LÍQUIDO LIQUID FLOCCULANT
FLOCULANT LIQUIDE FLOCCULANTE LIQUIDO

FLOCULANT

LÍQUIDO LIQUID LIQUIDE LIQUIDO



Ref. 76011 1 L pack 12

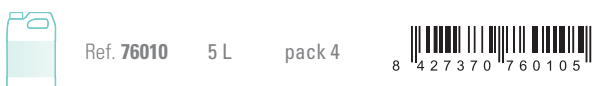

Ref. 76010 5 L pack 4



Para clarificar el agua y eliminar las materias en suspensión.
Recupera el agua turbia.
To clarify water and eliminate substances in suspension.
Retrieve the cloudy water.
Pour clarifier l'eau et éliminer les matières en suspension.
Récupère l'eau trouble.
Rende acqua cristallina ed elimina le particelle in superficie.
Recupera l'acqua torbida.

CARTUCHOS 125g 125g CARTRIDGES CARTOUCHES 125g CARTUCCIA 125g



Ref. 76044 1 Kg pack 14



Para mejorar la calidad de filtración (filtros de arena únicamente).
Producto de mantenimiento.
To increase filtration quality (sand filters only).
Product Maintenance.
Pour améliorer la qualité de filtration (filtres à sable uniquement).
Produit de maintenance.
Per migliorare la qualità della filtrazione (solo per filtri a sabbia).
Prodotto di mantenimento.

PRODUCTOS COMPLEMENTARIOS COMPLEMENTARY PRODUCTS
PRODUITS COMPLÉMENTAIRES PRODOTTI COMPLEMENTARI

DESINCRUSTANTE DE SUPERFICIE
SURFACE DESCALER
DÉTARTRANT DE SURFACE
PULITORE SUPERFI CI D'ACQUA

DETATANT SURFACE

LÍQUIDO LIQUID LIQUIDE LIQUIDO



Ref. **76046** 1 L pack 12



Para eliminar incrustaciones de cal.
 To eliminate lime scales.
 Pour éliminer les incrustations calcaires.
 Per evitare la incrostazione del calcare.

LIMPIADOR DE BORDES
WATERLINE CLEANER
NETTOYANT LIGNE D'EAU
PULITORE SUPERFICI D'ACQUA

NETTOYANT LIGNE D'EAU

LÍQUIDO LIQUID LIQUIDE LIQUIDO



Ref. **76047** 1 L pack 12



Para eliminar la suciedad de la línea de flotación.
 To eliminate the dirt on the waterline.
 Pour éliminer la saleté sur la ligne d'eau.
 Per eliminare particelle in superficie.



ANTICALCÁREO ANTI LIME
ANTI-CALCAIRE ANTICALCARE

ANTICALC

LÍQUIDO LIQUID LIQUIDE LIQUIDO



Ref. **76049** 1 L pack 12



Ref. **76048** 5 L pack 4



Para evitar la formación de cal.
 Secuestrante de metales (hierro, cobre...)
 To prevent lime formation.
 Metal Sequestering Agents (iron, copper...)
 Pour éviter la formation de calcaire.
 Séquestrant de métaux (fer, cuivre, etc.)
 Evita la formazione del calcare.
 Sequestrante di metalli (ferro, rame)

PRODUCTO QUÍMICO PARA EL INVIERNO CHEMICAL PRODUCTS FOR WINTER
PRODUITS CHIMIQUES POUR L'HIVER PRODOTTI CHIMICI PER L'INVERNO

Le facilitará la puesta en marcha de la piscina después del invierno, evitando la formación de algas y de cal.
 Realizar el proceso cuando la temperatura del agua de la piscina sea inferior a 15°C.

- 1) Limpiar la piscina.
- 2) Ajustar el pH entre 7,2 - 7,6
- 3) Realizar una cloración de choque
- 4) Dejar en funcionamiento el fi ltró hasta el día siguiente 5) Realizar una limpieza del fi ltró
- 6) Añadir el invernador

It makes easier for you the start-up of the pool after winter, avoiding algae and lime formation.

Please carry out the following if the temperature of the water drops below 15°C.

- 1) Clean the swimming pool
- 2) Set the pH balance between 7.2 – 7.6
- 3) Carry out a chlorine crash course
- 4) Leave the fi lter running until the following day
- 5) Clean the fi lter
- 6) Add the winterizing agent

Vous facilite la mise en route de la piscine après l'hiver en évitant la formation d'algues et de calcaire.
 Réaliser le processus lorsque la température de l'eau de la piscine est inférieure à 15°C.

- 1) Nettoyer la piscine
- 2) Ajuster le pH entre 7,2 - 7,6
- 3) Réaliser une chloration de choc
- 4) Laisser fonctionner le fi ltre jusqu'au lendemain
- 5) Nettoyer le fi ltre
- 6) Ajouter l'hivernant

Renderà più semplice l'inizio della nuova Stagione, dopo l'inverno, evitando la formazione di alghe e calcare.

Realizzare la procedura quando la temperatura dell'acqua della piscina è inferiore a 15°C.

- 1) Pulire la piscina
- 2) Regolare il pH tra 7,2 e 7,6
- 3) Eff ettuaré una clorazione d'urto
- 4) Lasciare in funzione il fi ltró fi no al giorno successivo
- 5) Eff ettuaré una pulizia del fi ltró
- 6) Aggiungere lo svernante



INVERNADOR WINTERISER
HIVERNAGE TRATTAMENTO PER L'INVERNO

HIVERNAGE

LÍQUIDO LIQUID LIQUIDE LIQUIDO



Ref. **76050** 1 L pack 12



Ref. **76051** 5 L pack 4



INVERNADOR CONCENTRADO CONCENTRATED
WINTERISER HIVERNAGE CONCENTRÉ
TRATTAMENTO PER L'INVERNO CONCENTRATO

HIVERNAGE CONCENTRÉ

LÍQUIDO LIQUID LIQUIDE LIQUIDO



Ref. **76017** 1 L pack 12



INVERNADOR CON BOYA FLOAT WINTERISER
BOUÉE HIVERNAGE TRATTAMENTO PER
L'INVERNO GALLEGGIANTE

HIVER FLOAT

PASTILLAS TABLETS PASTILLES PASTIGLIE



Ref. **76052** 2 Kg pack 6



REF. 90175

DIS PACK 14



Repulsivo Anti Insectos a base de aceites esenciales 100% naturales. Dosificación de 3 pastillas de 30g.

Répulsif Anti Insectes à base d'huiles essentielles 100% naturelles. Doseur de 3 pastilles de 30g.

Anti Insect repellent using 100% natural essential oils. 30 g 3 tablet dosifier.

Repellente anti-insetti a base di oli essenziali 100% naturali. Dosatore di 3 pastiglie da 30g.



REF. 90178

DIS PACK 12



Repulsivo Anti Insectos a base de aceites esenciales 100% naturales. Caja de 6 pastillas de 30g.

Répulsif Anti Insectes à base d'huiles essentielles 100% naturelles. Boite carton de 6 pastilles de 30g.

Anti Insect repellent using 100% natural essential oils. 30g 6 tablet box.

Repellente anti-insetti a base di oli essenziali 100% naturali. Confezione di 6 pastiglie da 30g.



REF. 90147

DIS PACK 12



Stop Aguas Verdes

Recupera las aguas verdes gracias a una nueva generación de polimeros hidrosolubles.

Caja de 6 pastillas de 20g.

Stop Eaux Vertes

Il récupère les eaux vertes grâce à une nouvelle génération de polymères hydrosolubles.

Boite carton de 6 pastilles de 20g.

Stop Green Waters

Get back the green waters of your pool thanks to a new generation of water soluble polymers.

20g 6 tablet box.

Stop Acque Verdi

Recupera le acque verdi grazie ad una nuova generazione di polimeri idrosolubili.

Confezione di 6 pastiglie da 20g.



REF. 90143

DIS PACK 12



Stop Aguas Turbias

Recupera las aguas turbias, y consigue un agua limpia y cristalina.

Caja de 6 pastillas de 30g.

Stop Eaux Troubles

Traite les eaux troubles, et rend l'eau propre et cristalline.

Boite carton de 6 pastilles de 30g.

Stop Cloudy Waters

Get back the cloudy waters to obtain a crystal-clear water.

30g 6 tablet box.

Stop Acque Torbide

Recupera le acque torbide, la sua efficacia permette di avere un'acqua limpida e cristallina.

Confezione di 6 pastiglie da 30g.



REF. SATC6

DIS PACK 12



Stop Aguas Turbias

Recupera las aguas turbias, y consigue un agua limpia y cristalina. Para piscinas con filtro de cartucho.

Caja de 6 pastillas de 17g.

Stop Eaux Troubles

Traite les eaux troubles, et rend l'eau propre et cristalline. Pour les piscines avec filtre à cartouche.

Boite carton de 6 pastilles de 17g.

Stop Cloudy Waters

Get back the cloudy waters to obtain a crystal-clear water. For pools with cartridge filter.

17g 6 tablet box.

Stop Acque Torbide

Recupera le acque torbide, la sua efficacia permette di avere un'acqua limpida e cristallina. Per le piscine con filtro a cartuccia.

Confezione di 6 pastiglie da 17g.



produits d'entretien [prodotti chimici

- Solución de tratamiento "Todo en Uno". Ideal piscinas elevadas con o sin filtración. Tratamiento mensual.
 - 4 Acciones: Higienizante, Antibacterias, Antialgas y Floculante
 - No hay manipulación directa de producto químico.
 No perjudica la filtración gracias a su forma optimizada que deja el circuito de agua intacto. El POOLP'O sube a la superficie una vez acabado el producto químico, avisando de la necesidad de empezar un nuevo tratamiento.

- Solution de traitement "Tout en Un". Idéal Piscines hors-sol avec ou sans filtration. Traitement mensuel.
 - 4 Actions: Hygiénisant, Anti-bactéries, Anti-algues, Floculant.
 - Pas de manipulation directe de produit chimique.
 Ne gêne pas la filtration grâce à sa forme optimisée qui laisse le circuit de l'eau intact. Ne gêne pas le volet du skimmer de part sa petite taille. Le POOLP'O remonte à la surface une fois le produit consommé vous avisant de la nécessité de recommencer un traitement.

- Treatment solution "All in One" for Above ground Pools with and without filtration. Monthly treatment.
 - 4 actions: Sanitizing, Anti-bacteria, Anti-algae and Flocculant.
 - No direct handling of chemical product. It does not obstruct filtration thanks to its form optimized – which leaves the circuit of water intact. It goes up once product finished, so you know you should start a new treatment.

- Soluzione "Tutto in uno". Adatto per piscine fuori terra con o senza filtrazione. Trattamento mensile
 - 4 azioni: Igienizzanti, Anti- batteri, Antialghe e Flocculante
 - Non c'è contatto diretto con il prodotto chimico. Non danneggia la filtrazione grazie alla sua forma che lascia libero il circuito dell'acqua. El Poolp'o sale in superficie una volta terminato il prodotto chimico, avvisando della necessità di dover iniziare un nuovo trattamento



REF. 08012

BX PACK 16



POOLP'O 0-10m³ (250g)
 POOLP'O 0-10m³ (250g)

POOLP'O 0-10m³ (250g)
 POOLP'O 0-10m³ (250g)

REF. 08112

DIS 18



Display **POOLP'O 0-10m³ (250g)**
 18 unidades
POOLP'O 0-10 m³ (250g) Display 18
 unités

Display **POOLP'O 0-10 m³ (250g)**
 18 units
 Display **POOLP'O 0-10 m³ (250g)**
 18 unità



REF. 08013A

BX PACK 16



POOLP'O 10-20m³ (500g)
 POOLP'O 10-20m³ (500g)

POOLP'O 10-20m³ (500g)
 POOLP'O 10-20m³ (500g)

REF. 08113

DIS 18



Display **POOLP'O 10-20m³ (500g)**
 18 unidades
POOLP'O 10-20m³ (500g) Display
 18 unités

Display **POOLP'O 10-20m³ (500g)**
 18 units
 Display **POOLP'O 10-20m³ (500g)**
 18 unità



REF. 08099A

BX PACK 9



POOLP'O 10-30m³ (700g)
 Dosificador flotante con tratamiento químico. Duración 3 semanas

POOLP'O 10-30m³ (700g)
 Chemical treatment floating dispenser.
 3 weeks

POOLP'O 10-30m³ (700g)
 Doseur flottant chimique tout en un.
 Durée 3 semaines.

POOLP'O 10-30m³ (700g)
 Dispenser galleggiante con
 trattamento chimici. 3 settimane.

REF. 76053

PACK 12



Kit para piscina de 0 a 5m³

Cloro lento pastillas de 5 g - 500 g
+ Dosificador + Pelota

Kit pour piscine de 0 à 5m³

Chlore lent pastilles de 5 g - 500 g
+ Doseur + Ballon

Kit for 0-5m³ pool

Trichlorine 5g tablets - 500 g +
Dispenser + Ball

Kit per piscine da 0 a 5m³

Cloro lento pastiglie da 5 g - 500g +
dosatore + palla gonfiabile



REF. 76054

PACK 6



Kit para piscina de 5 a 15m³

Multifunciones pastillas 20g, 1Kg +
Dosificador + Termómetro + Analizador
+ Manguitos + Kit reparación liner

Kit pour piscine de 5 à 15m³

Multifonction pastilles 20g, 1 kg + Doseur +
Thermomètre + Trousse
d'analyse + Brassards + Kit réparation liner

Kit for 5-15m³ pool

Multiactions 20g tablets, 1Kg +
Dispenser + Thermometer + Test kit
+ Arm-bands + Liner repair kit

Kit per piscine da 5 a 15m³

4 azioni pastiglie da 20g, formato 1 Kg
+ Dosatore + termometro + Kit analisi
+ Bracciali + Kit riparazione liner



REF. KITSPA

PACK 2



Kit para SPA

Oxígeno tabletas 20gr (1kg) +
Minorador de pH granulado (1,5kg)
+ Antiespumante (500ml) + Algicida no
espumante (1l) + Anticalcáreo (500ml) +
Estuche analizador Cl/Br/Ox/pH

Kit pour Spa

Oxygène galets 20gr (1kg) +
Baisse le pH granulé (1,5kg) +
Antimousse (500ml) + Algicide
non moussant (1l) + Anti-calcaire
(500ml) + Trousse de Cl/Br/Ox/pH

SPA Kit

Oxygen 20gr tablets (1kg) + pH reduce
granules (1,5kg) + Antifoam (500ml) +
Non-foaming algicide (1l) + Anti lime
(500ml) + Cl/Br/Ox/pH test kit

Kit per Spa

Ossigeno pastiglie da 20gr (1kg)
+ Riduttore pH granulato (1,5kg)
+ Antischiuma (500ml) + Non
schiumogeno algicida (1l) + Anticalcare
(500ml) + Kit analisi Cl Br/Ox/pH



REF. 76058

PACK 4



Multiacción: 16 dosis de 250g.
Fácil de usar, dosis exacta.
Para piscinas hasta 60m³.

Chloration choc : 16 doses de 250g.
Facile à utiliser, dose précise.
Pour piscines de jusqu'à 60m³.

Multiaction: 250gr 16 dose
Easy to use, accurate dose.
Pools up to 60m³.

Multi funzioni: 8 dosi da 100 grammi
Semplice da utilizzare: eroga sempre la
dose corretta. Per piscine fino a 60 m³.



REF. UFG90

DIS PACK 36



Ultraflock

Gel floculante en monodosis de 90g.

Ultraflock

Floculant Gel gousse de 90g.

Ultraflock

Flocculant Gel 90g pods.

Ultraflock

90g flocculante gel.



TESTERS DIGITALES DIGITAL TESTERS
TESTEURS DIGITAL TESTER DIGITALE



REF. 38813

CS PACK 6



Aquacheck

Lector digital de tiras de análisis TruTest. Analiza los niveles de cloro/bromo libre, valor pH y alcalinidad total.

Aquacheck

Digital Test Strip Reader. Tests for: Free Chlorine, pH, Total Alkalinity.

Aquacheck

Lecteur digital de bandelettes d'analyse TruTest. Résultats de Chlore/Brome libre, pH et Alcalinité totale.

Aquacheck

Digital Test striscia lettore TruTest: cloro / bromo-libero, il pH e l'alcalinità totale.



REF. 40817

BL PACK 12



Recambio para el Aquacheck True Test: 25 tiras analíticas.

Aquacheck True Test refill: 25 test strips.

Recharge pour Aquacheck TruTest.: 25 languettes d'analyse

Ricarica di Aquacheck TruTest: 25 strisce di analisi.



REF. TD61

CS PACK 8



Tester digital de 6 lecturas: pH, Cloro libre, Salinidad, TDS (Tasa total de solidos disueltos en el agua), ORP, Temperatura

6 readings digital tester: pH, FC (free chlorine), Salinity, TDS (Total disolve solids), ORP, Temperature

Testeur digital 6 lectures: pH, Chlore libre, Salinité, TDS (total des solidos dissous taux dans l'eau), ORP, Température

Tester digitale 6 lecture: pH, Cloro libero, Salinità, TDS (totale di solidi disciolti tasso in acqua), ORP, Temperatura



REF. TDS10

CS PACK 8



Tester digital para piscinas y spas. Mide el nivel de sal en el agua y la temperatura.

Digital salt tester for pools and spas. Designed to test water salt in pools and spas.

Testeur digital pour piscines et SPA. Mesure le niveau de sel et la température.

Tester digitale. Misuratore unico progettato per esaminare il dosaggio di sale in piscine e vasche di bellezza.

ANALIZADORES TEST KITS
TROUSSES D'ANALYSE KIT TEST

REF. 40060

DIS 1/2N BL PACK 32



Analizador de cloro/bromo + pH (Oto/Phenol)

Test kit chlorine/bromine + pH (Oto/Phenol)

Trousse chlore/brome + pH (Oto/Phénol)

Kit analisi cloro/bromo + pH (oto/Phenol)



REF. 40061

DIS 1/2N BL PACK 24



Recambio Oto/Phenol
Recharge Oto/Phénol

Refi II Oto/Phenol
Ricambio Oto/Phenol



REF. 40062

DIS 1/8N CS PACK 24



Comparador cloro + pH - pastillas DPD1
Trousse chlore + pH - pastilles DPD1

Test kit chlorine + pH - DPD1 tablets
Kit analisi cloro + ph - pastiglie DPD1



REF. 40063

DIS 1/8 BL PACK 24



Recambio pastillas DPD1
Recharge pastilles DPD1

Refi II DPD1 tablets
Ricarica pastiglie DPD1





REF. 40066

DIS 1/8 CS PACK 24



Kit de análisis de oxígeno/bromo + pH -
pastillas DPD4

Trousse de oxygène/brome + pH pastilles
DPD4

Oxygen / bromine + pH test kit - DPD4
tablets

Kit analisi ossigeno/bromo + pH
pastiglie DPD4



REF. 40067

DIS 1/8 BL PACK 24



Recambio pastillas DPD4

Recharge pastilles DPD4

Refi II DPD4 tablets

Ricarica pastiglie DPD4

TIRAS DE ANÁLISIS TEST STRIPS LANGUETTES D'ANALYSE CARTINE TORNASOLE



REF. 40068

1/8 BL PACK 16



Análisis cloro + pH + alcalinidad
(50 tiras).

Analyse chlore + pH + alcalinité
(50 languettes).

Chlorine + pH + alkalinity analysis
(50 strips).

Analisi cloro + pH + alcalinità
(50 strisce).



REF. 40069

BX PACK 12



Analiza el nivel de sal en agua
(16 tiras).

Analyse le niveau de Sel de l'eau
(16 languettes).

Salt level in water analysis
(16 strips).

Analizza il livello di sale nell'acqua
(16 strisce).

material plv pos material matériels plv materiale pos



TOTEMS



FOLLETOS LEAFLETS DÉPLIANTS VOLANTINI



DVDs

www.gre.es

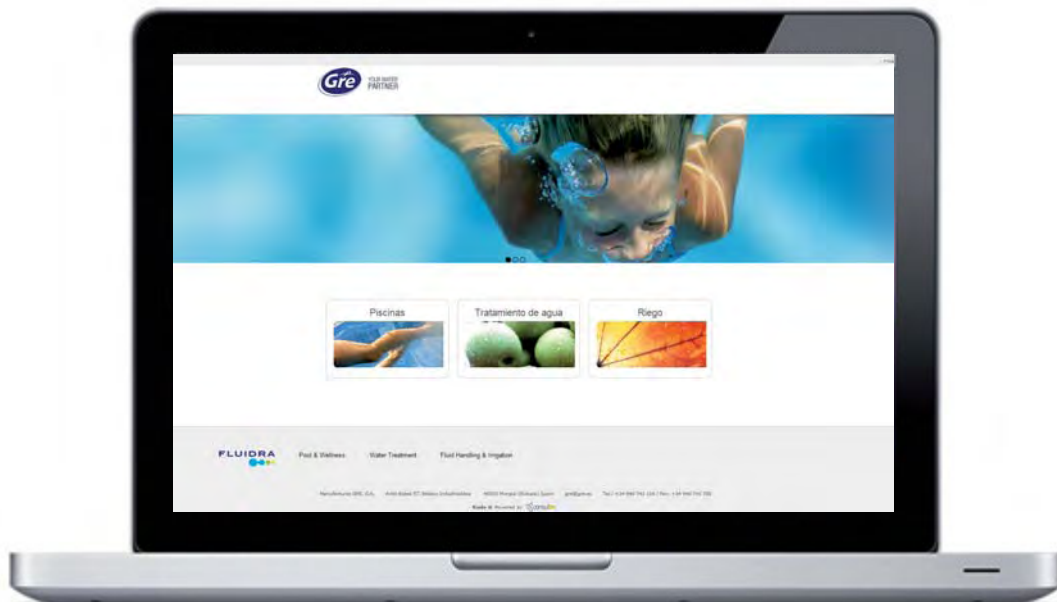

Nos reservamos el derecho de cambiar total o parcialmente las características de nuestros artículos o el contenido de este documento sin previo aviso. Fotos e imágenes no contractuales.

We reserve the right to change all or part of the articles or contents of this document without prior notice. Photos and pictures are not contractual.

Nous nous réservons le droit de modifier totalment ou en partie les caractéristiques de nos articles ou le contenu de ce document sans préavis. Photos et images non contractuelles.

Ci riserviamo il diritto di cambiare totalmente o parzialmente le caratteristiche tecniche dei nostri prodotti ed il contenuto di questo documento senza nessun preavviso. La Fotografia o il disegno è solo a scopo illustrativo ed informativo.



www.gre.es

Manufacturas GRE S.A. | Aritz Bidea nº 57 | Belako Industrialdea | Apartado 69 | 48100 Mungia (Bizkaia) Spain
Tel. (34) 946 741 116 | Fax (34) 946 741 708 | gre@gre.es

