

Beatbot

AquaSense Pro

# QUICK USER GUIDE



EN FR ES DE IT NL

## Product Structure Diagram

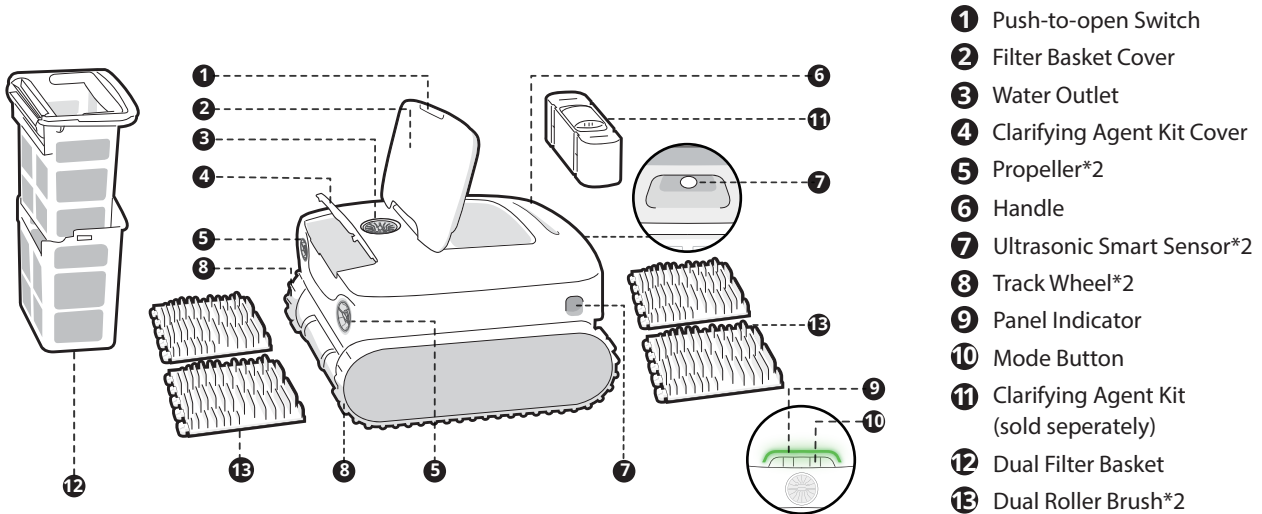

## Robot Button

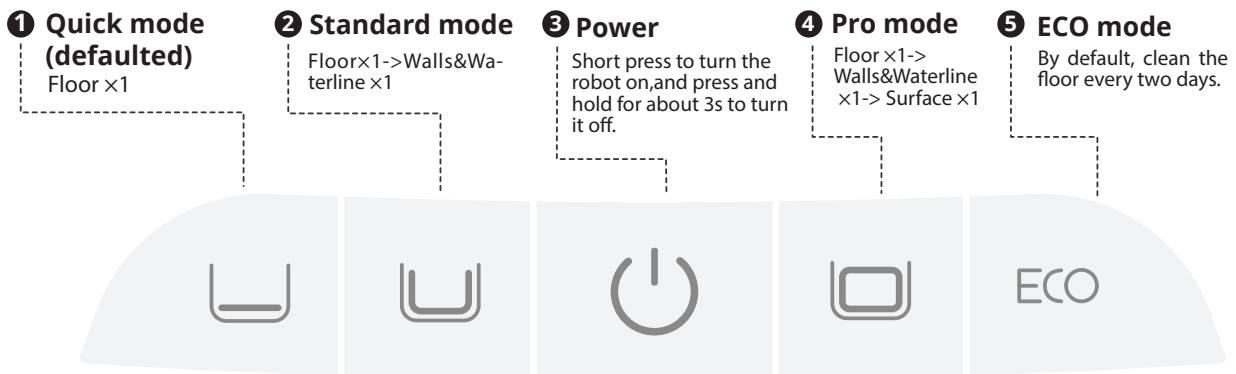

### • Hotspot Configuration

Press and hold both "Power" + "Quick Mode" buttons for about 3s to trigger the hotspot configuration.

### • Factory Reset

Press and hold "Standard mode" + "Power" + "Pro Mode" buttons for about 10s to restore the factory settings.

## APP

### APP Download

You can either scan the QR code below or search for "Beatbot" in the App Store or Google Play to download the APP.



### Robot Connection

Please check the following items before connecting:

- Make sure the robot is turned on;
- Confirm that both your mobile phone and the robot are within the same Wi-Fi coverage range with a strong signal;
- Keep the phone close to the robot (within 1m distance);
- Ensure your phone is connected to Wi-Fi, supporting only the 2.4GHz network.

After powering on, press the "Power" and "Quick Mode" buttons simultaneously for about 3s, and when you see the indicator flashing blue, the robot is ready for network setup. Then, choose either of the following methods to complete the connection:

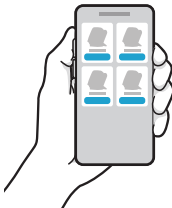
	<p><b>A</b></p> <p><b>Scan to add:</b> Tap the "Scan to Add" on the home page of the App, aim the camera at the QR code on the robot and follow the App instructions to complete the connection.</p>	<p><b>OR</b></p> 	<p><b>B</b></p> <p><b>Add manually:</b> Tap the "Add Device" on the home page of the App, choose your robot model, and follow the App instructions to complete the connection.</p>
---	--	---	--

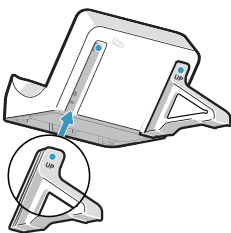
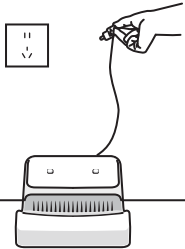
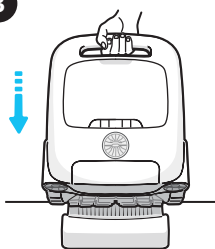
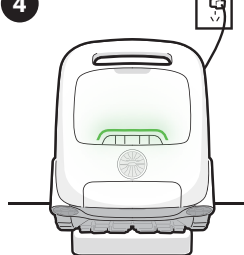

## Preparation Before Use

### Charging

			
<p>1</p> <p>Install the charge dock</p>	<p>2</p> <p>Plug into the power supply</p>	<p>3</p> <p>Place the robot</p>	<p>4</p> <p>Charging</p>

### Before Cleaning

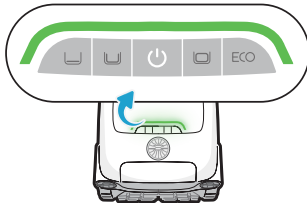
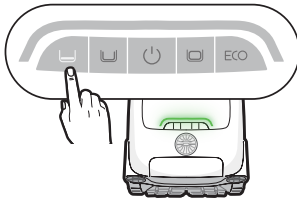
**!** Before entering the water, it is crucial to place the robot on a level ground and to wait for about 5s for it to calibrate. By following these steps, you ensure maximize the effectiveness of the robot's cleaning path. The robotic pool cleaner will automatically disconnect from the phone after entering the water.

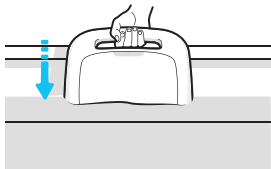
			
<p>1</p> <p>Ensure the robot has sufficient power (the indicator shows solid green).</p>	<p>2</p> <p>Set the cleaning mode, and the selected mode button will show solid white.</p>	<p>3</p> <p>Place the robot on a level ground and wait for about 5s for it to calibrate.</p>	<p>4</p> <p>Place the robot in the water to start automatic cleaning.</p>

After the cleaning task is completed, the robot will automatically dock on the surface next to the wall. But if the robot is pulled out with a hook during cleaning, it will not have enough time to drain, and the robot will not surface. Please continue to let the robot drain for 2-3 minutes.

### Tips

 If this is your first time using the pool this season, we recommend that you clean it manually first by removing any large debris. After that, you can use the robotic pool cleaner to maintain the cleanliness. This is because if there's a lot of debris left in the pool during the off-season, using the robot will cause the filter basket to clog more quickly and require more frequent cleaning. Therefore, it's more convenient to start with manual cleaning.

 Each machine undergoes thorough testing, including underwater testing, before leaving the factory. As a result, there may be some residual water stains, which is normal. Please feel free to use it.

## Diagramme de structure de produit

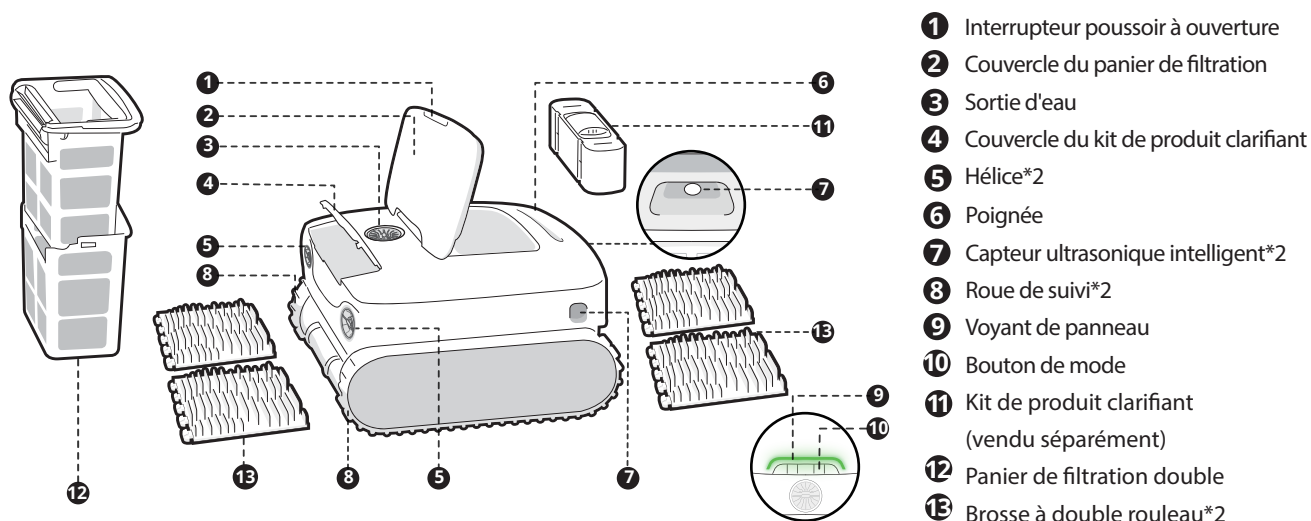

## Bouton du robot

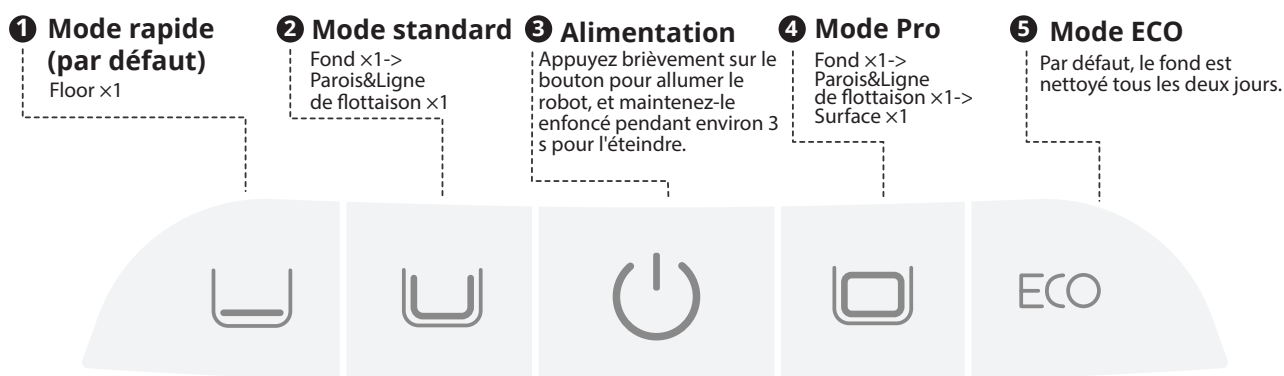

### • Configuration du hotspot

Appuyez sur les deux boutons "Alimentation"+" ( ) Mode **3** rapide" ( ) et maintenez-les enfoncés pendant environ 3 s pour déclencher la configuration du hotspot.

### • Réinitialisation d'usine

Appuyez sur les boutons "Mode standard" ( ) + **2** Alimentation " ( ) + **3** Mode Pro " ( ) et maintenez-les enfoncés pendant environ 10 s pour rétablir les paramètres d'usine.

## APPLI

### Téléchargement de l'APPLI

Vous pouvez soit scanner le code QR ci-dessous, soit rechercher « Beatbot » dans l'App Store ou Google Play pour télécharger l'APPLI.



### Connexion du robot

Veuillez vérifier les éléments suivants avant de vous connecter :

- Assurez-vous que le robot est sous tension ;
- Vérifiez que votre téléphone portable et le robot se trouvent dans la même zone de couverture wi-fi et que le signal est puissant ; Assurez-vous que votre téléphone est connecté au wi-fi et qu'il ne prend en charge que le réseau 2,4 GHz ;
- Approchez le téléphone du robot (la distance entre votre téléphone et le robot doit être inférieure à 1 m).

Une fois le robot nettoyeur mis sous tension, appuyez simultanément sur les boutons « Alimentation » et « Mode rapide » pendant environ 3 secondes. Lorsque le voyant clignote en bleu, le robot nettoyeur est prêt pour la configuration du réseau. Alors, choisissez l'une des méthodes suivantes pour terminer la connexion :

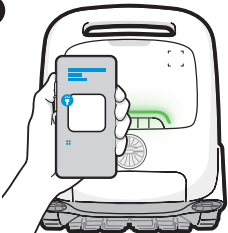
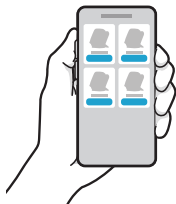
	<p><b>A</b></p> <p><b>Scanner pour ajouter :</b> Appuyez sur le bouton "Scanner pour ajouter" sur la page d'accueil de l'appli, dirigez la caméra vers le code QR du robot et suivez les instructions de l'appli pour terminer la connexion.</p>		<p><b>B</b></p> <p><b>Ajouter manuellement :</b> Appuyez sur le bouton "Ajouter un appareil" sur la page d'accueil de l'appli, choisissez votre modèle de robot et suivez les instructions de l'appli pour terminer la connexion.</p>
---	--	--	---

## Fonctionnement du produit

### Recharge

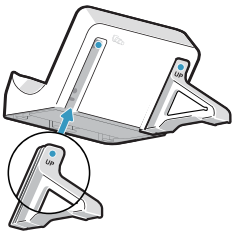
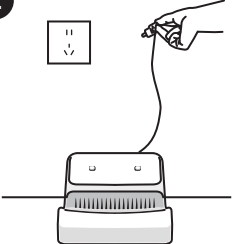
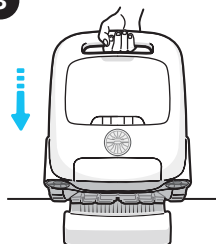
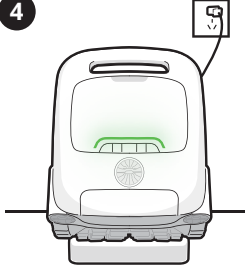
			
<p>1</p> <p>Installez la station de recharge</p>	<p>2</p> <p>Branchez l'alimentation électrique</p>	<p>3</p> <p>Placez le robot</p>	<p>4</p> <p>Recharge en cours</p>

### Avant le nettoyage

**!** Avant de le mettre à l'eau, il est essentiel de placer le robot sur un sol plat et d'attendre environ 5 s pour qu'il se calibre. En suivant ces étapes, vous maximisez l'efficacité du trajet de nettoyage du robot. Le robot nettoyeur de piscine se déconnecte automatiquement du téléphone après avoir pénétré dans l'eau.

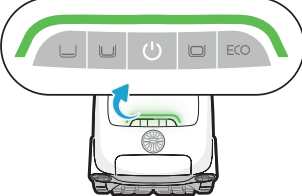
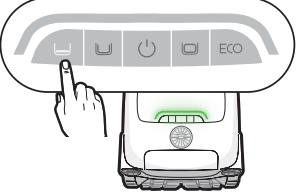
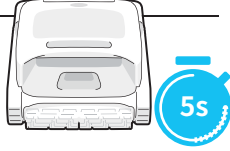
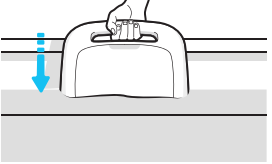
			
<p>1</p> <p>Assurez-vous que le robot a suffisamment de puissance (le voyant est vert permanent).</p>	<p>2</p> <p>Réglez le mode de nettoyage et le bouton de mode sélectionné affichera un blanc fixe.</p>	<p>3</p> <p>Placez le robot sur un fond de niveau et attendez environ 5 s pour le calibrer.</p>	<p>4</p> <p>Placez le robot dans l'eau pour lancer le nettoyage automatique.</p>

Une fois la tâche de nettoyage terminée, le robot se pose automatiquement sur la surface à côté de la paroi. Mais si le robot est retiré avec un crochet pendant le nettoyage, il n'aura pas le temps de se vidanger et le robot ne remontera pas à la surface. Continuez à laisser le robot se vidanger pendant 2 à 3 minutes.

### Conseils



Si vous utilisez la piscine pour la première fois de la saison, nous vous recommandons de la nettoyer au préalable manuellement en retirant tous les débris de grande taille. Ensuite, vous pouvez utiliser le robot nettoyeur de piscine afin de préserver sa propreté. En effet, si de nombreux débris sont restés dans la piscine au cours de l'intersaison, l'utilisation du robot accélérera l'obturation du panier de filtration et nécessitera des nettoyages plus fréquents. Par conséquent, il est plus judicieux de procéder d'abord à un nettoyage manuel.



Chaque machine est soumise à des tests approfondis, y compris des tests sous-marins, avant de quitter l'usine. En conséquence, il peut y avoir des taches d'eau résiduelles, ce qui est normal. N'hésitez pas à l'utiliser.

## Diagrama de estructura de producto

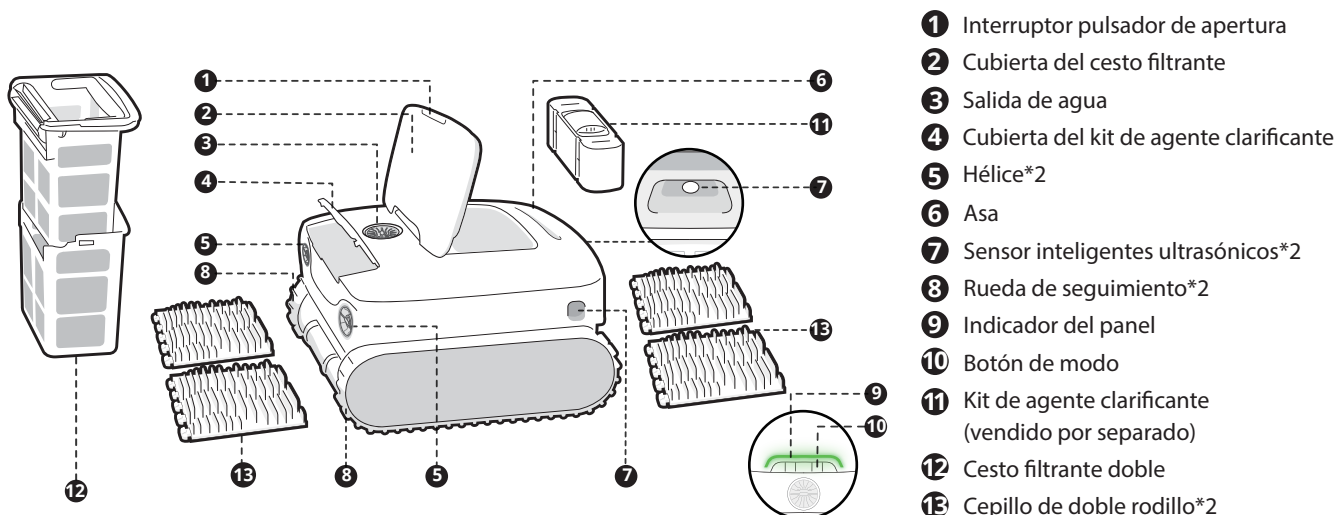

## Botón del robot

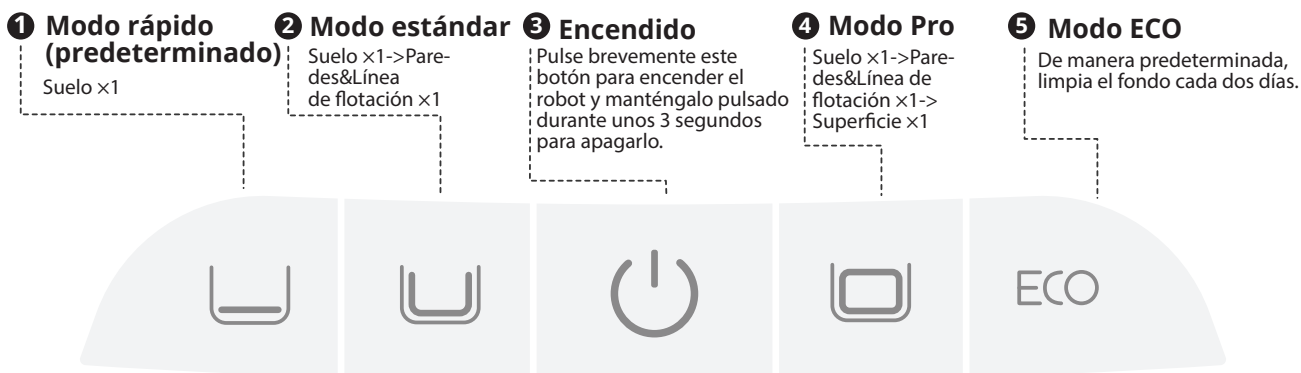

### • Configuración del punto de conexión

Pulse y mantenga los botones de "Encendido"+" ( ) **3** "Modo rápido" ( ) durante **1** te aproximadamente 3 segundos para activar la configuración del punto de conexión.

### • Restablecimiento de ajustes de fábrica

Pulse y mantenga los botones de "Modo estándar" ( ) + **2** "Encendido" ( ) + "Modo Pro" ( ) durante **4** aproximadamente 10 segundos para restaurar los ajustes de fábrica.

## APP

### Descarga de la APP

Puede escanear el código QR que aparece a continuación o buscar "Beatbot" en el App Store o en Google Play para descargar la app.



### Conexión del robot

Antes de efectuar la conexión, compruebe los siguientes puntos:

- Asegúrese de que el robot está encendido.
- Confirme que tanto el teléfono móvil como el robot se encuentran dentro del mismo alcance de cobertura Wi-Fi con una señal intensa.
- Compruebe que su teléfono está conectado a la Wi-Fi, compatible solo con la red de 2,4 GHz.
- Aproxime el teléfono al robot (la distancia entre el teléfono y el robot debe ser de 1 m como máximo).

Tras encender el robot, pulse simultáneamente los botones "Encendido" y "Modo rápido" durante unos 3 segundos y, cuando vea que el indicador parpadea en azul, el robot estará listo para la configuración de la red. Entonces, elige cualquiera de los siguientes métodos para completar la conexión:

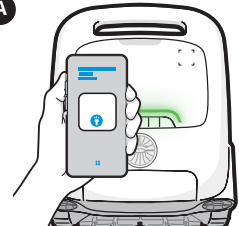
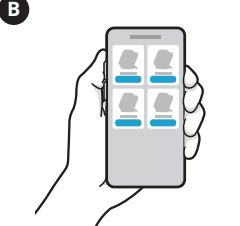
	<p><b>A Escanear para añadir:</b> Toque la opción "Escanear para añadir" en la página de inicio de la App, apunte la cámara al código QR del robot y siga las instrucciones de la App para completar la conexión.</p>		<p><b>B Añadir manualmente:</b> Toque la opción "Añadir dispositivo" en la página de inicio de la App, seleccione el modelo de robot y siga las instrucciones de la App para completar la conexión.</p>
---	---	--	---

## Uso del producto

### Carga

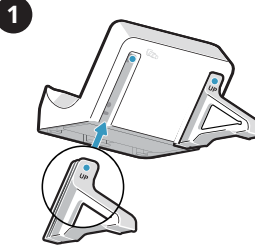
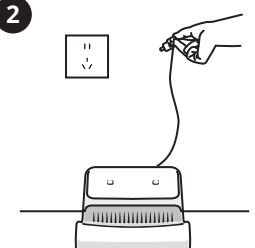
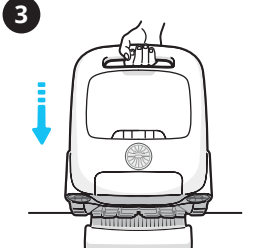
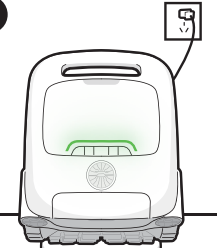
 <p>1 Instale el dock de carga</p>	 <p>2 Enchúfelo en la toma de alimentación</p>	 <p>3 Coloque el robot</p>	 <p>4 Cargando</p>
---	---	--	---

### Antes de limpiar

**!** Antes de introducirlo en el agua, es fundamental colocar el robot sobre un terreno nivelado y esperar unos 5 segundos para que se calibre. Siguiendo estos pasos, se garantiza la máxima efectividad del recorrido de limpieza del robot. El robot limpiafondos se desconectará automáticamente del teléfono al entrar en el agua.

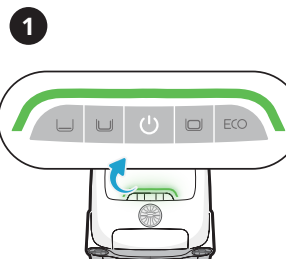
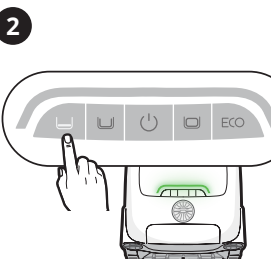
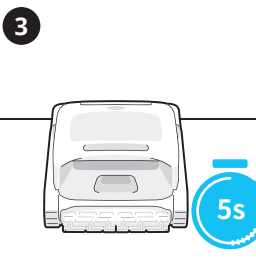
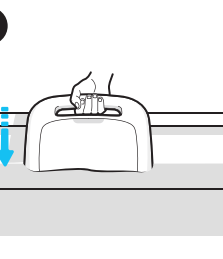
 <p>1 Compruebe que el robot tiene carga suficiente (el indicador muestra una luz verde fija).</p>	 <p>2 Configure el modo de limpieza y el botón de modo seleccionado se mostrará en blanco fijo.</p>	 <p>3 Coloque el robot sobre un terreno nivelado y espere unos 5 segundos para que se calibre.</p>	 <p>4 Introduzca el robot en el agua para comenzar la limpieza automática.</p>
---	--	--	---

Una vez completada la tarea de limpieza, el robot atracará automáticamente en la superficie situada junto a la pared. Pero si se saca el robot con un gancho durante la limpieza, no tendrá tiempo suficiente para drenar y no saldrá a la superficie. Deje el robot drenar durante 2-3 minutos.

### Sugerencias

 Si es la primera vez que utiliza la piscina esta temporada, le recomendamos que primero la limpie manualmente retirando los residuos grandes. Después, puede utilizar el robot limpiafondos para mantener la limpieza. Esto se debe a que si quedan muchos residuos en la piscina durante la temporada baja, usar el robot directamente hará que el cesto filtrante se atasque más rápidamente y requiera una limpieza más frecuente. Por lo tanto, es mejor empezar con la limpieza manual.

 Cada máquina se somete a pruebas exhaustivas, incluidas pruebas bajo el agua, antes de salir de fábrica. Como resultado, puede haber algunas manchas de agua residuales, lo cual es normal. Por favor, siéntase libre de usarlo.

## Produktstrukturdiagramm

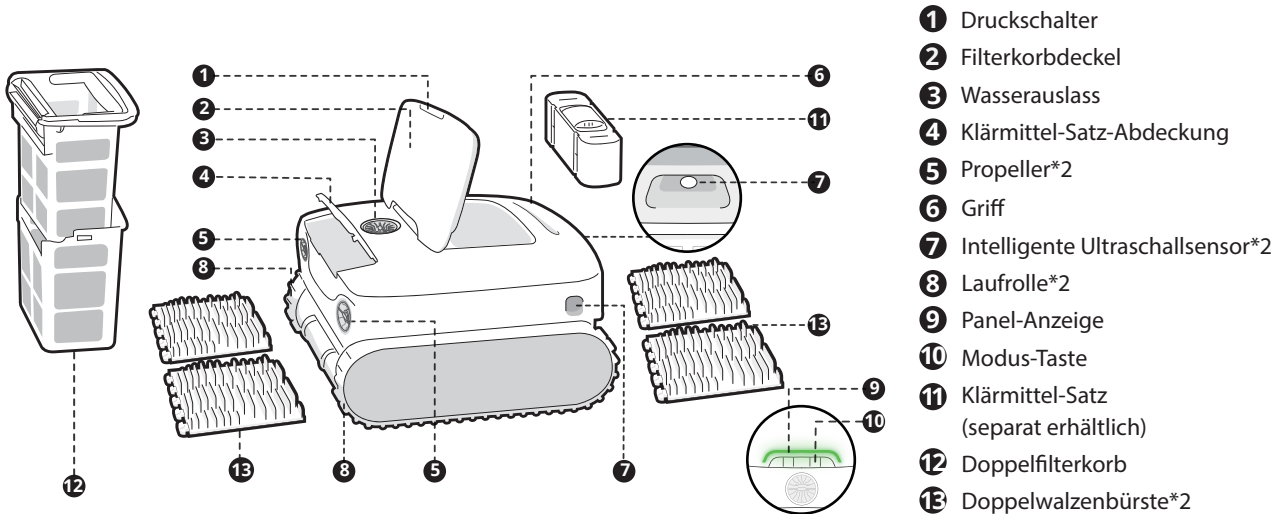

## Roboter-Taste



### • Hotspot-Konfiguration

Drücken und halten Sie die beiden Tasten „Power“ ( ) und „**3** Schnellmodus“ ( ) für ca. 3s, um **1** Hotspot-Konfiguration auszulösen.

### • Zurücksetzen auf Werkseinstellungen

Halten Sie die Tasten „Standard-modus“ ( ) und **2** „Power“ ( ) und **3** „Pro-Modus“ ( ) etwa 10 **4** Sekunden lang gedrückt, um die Werkseinstellungen wiederherzustellen.

## APP

### Descarga de la APP

Sie können entweder den QR-Code unten scannen oder im App Store oder bei Google Play nach „Beatbot“ suchen, um die APP herunterzuladen.



### Conexión del robot

Bitte überprüfen Sie vor dem Anschließen die folgenden Punkte:

- Vergewissern Sie sich, dass der Roboter eingeschaltet ist;
- Vergewissern Sie sich, dass sich sowohl Ihr Mobiltelefon als auch der Roboter im gleichen WLAN-Abdeckungsbereich befinden und ein starkes Signal haben;
- Vergewissern Sie sich, dass Ihr Telefon mit WLAN verbunden ist und nur das 2,4-GHz-Netz unterstützt;
- Bringen Sie das Telefon in die Nähe des Roboters (der Abstand zwischen Ihrem Telefon und dem Roboter sollte weniger als 1 m betragen).

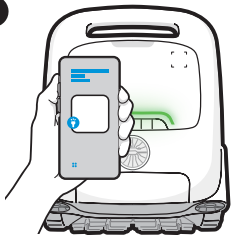
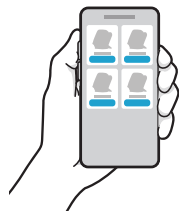

Nach dem Einschalten drücken Sie die Tasten „Power“ und „Schnellmodus“ gleichzeitig für ca. 3 Sekunden. Wenn die Anzeige blau blinkt, ist der Roboter bereit für die Netzwerkeinrichtung. Dann wählen Sie entweder von den folgenden Methoden aus, um die Verbindung abzuschließen:

<p><b>A</b></p> 	<p><b>Zum Hinzufügen scannen:</b> Tippen Sie auf der Startseite der App auf "Scannen zum Hinzufügen", richten Sie die Kamera auf den QR-Code des Roboters und folgen Sie den Anweisungen der App, um die Verbindung herzustellen.</p>	<p><b>B</b></p> 	<p><b>Manuell hinzufügen:</b> Tippen Sie auf der Startseite der App auf "Gerät hinzufügen", wählen Sie Ihr Robotermodell und folgen Sie den Anweisungen der App, um die Verbindung herzustellen.</p>
---	---	--	--

## Produktbetrieb

### Wird geladen

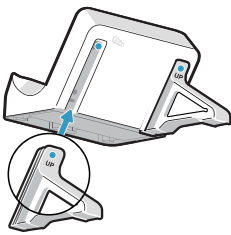
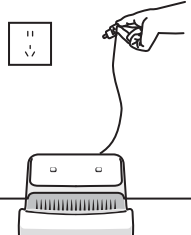
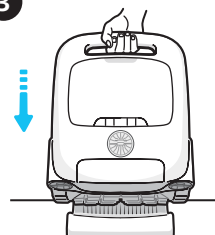
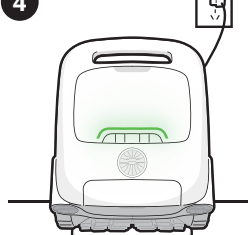
<p><b>1</b></p> 	<p><b>2</b></p> 	<p><b>3</b></p> 	<p><b>4</b></p> 
<p>Installieren Sie die Ladestation</p>	<p>Schließen Sie das Gerät an die Stromversorgung an</p>	<p>Platzieren Sie den Roboter</p>	<p>Wird geladen</p>

### Vor der Reinigung

**!** **Bevor er ins Wasser gesetzt wird, müssen Sie den Roboter auf eine ebene Fläche stellen und etwa 5 Sekunden warten, bis er sich kalibriert hat. Wenn Sie diese Schritte befolgen, maximieren Sie die Effektivität der Reinigungsstrecke des Roboters. Der Poolreinigungsroboter trennt automatisch die Verbindung zum Telefon, wenn er ins Wasser eintaucht.**

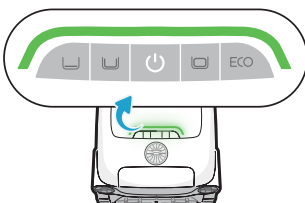
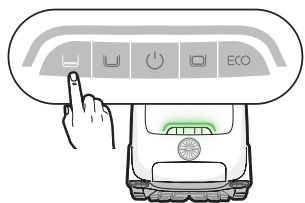
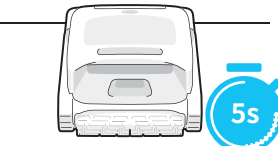
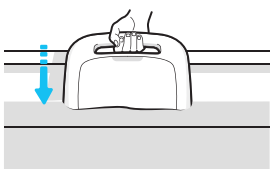
<p><b>1</b></p> 	<p><b>2</b></p> 	<p><b>3</b></p> 	<p><b>4</b></p> 
<p>Vergewissern Sie sich, dass der Roboter ausreichend Strom hat (die Anzeige leuchtet grün).</p>	<p>Stellen Sie den Reinigungsmodus ein, und die Schaltfläche für den ausgewählten Modus wird durchgehend weiß angezeigt.</p>	<p>Stellen Sie den Roboter auf eine ebene Fläche und warten Sie etwa 5 Sekunden, bis er kalibriert ist.</p>	<p>Setzen Sie den Roboter in das Wasser, um die automatische Reinigung zu starten.</p>

Nach Beendigung der Reinigung dockt der Roboter automatisch an die Oberfläche neben der Wand an. Wenn der Roboter jedoch während der Reinigung mit einem Haken herausgezogen wird, hat er nicht genug Zeit, sich zu entleeren, und der Roboter taucht nicht auf. Bitte lassen Sie den Roboter noch 2-3 Minuten lang abtropfen.

### 💡 Tipps



Wenn Sie den Pool in dieser Saison zum ersten Mal benutzen, empfehlen wir Ihnen, ihn zuerst manuell zu reinigen, indem Sie große Ablagerungen entfernen. Danach können Sie den Roboter-Poolreiniger verwenden, um die Sauberkeit zu erhalten. Denn wenn in der Nebensaison viel Schmutz im Pool verbleibt, führt der Einsatz des Roboters dazu, dass der Filterkorb schneller verstopft und häufiger gereinigt werden muss. Daher ist es bequemer, mit der manuellen Reinigung zu beginnen.



Jede Maschine wird gründlich getestet, auch unter Wasser, bevor sie das Werk verlässt. Infolgedessen kann es zu einigen Wasserflecken kommen, was normal ist. Bitte zögern Sie nicht, es zu verwenden.

## Diagramma di struttura del prodotto

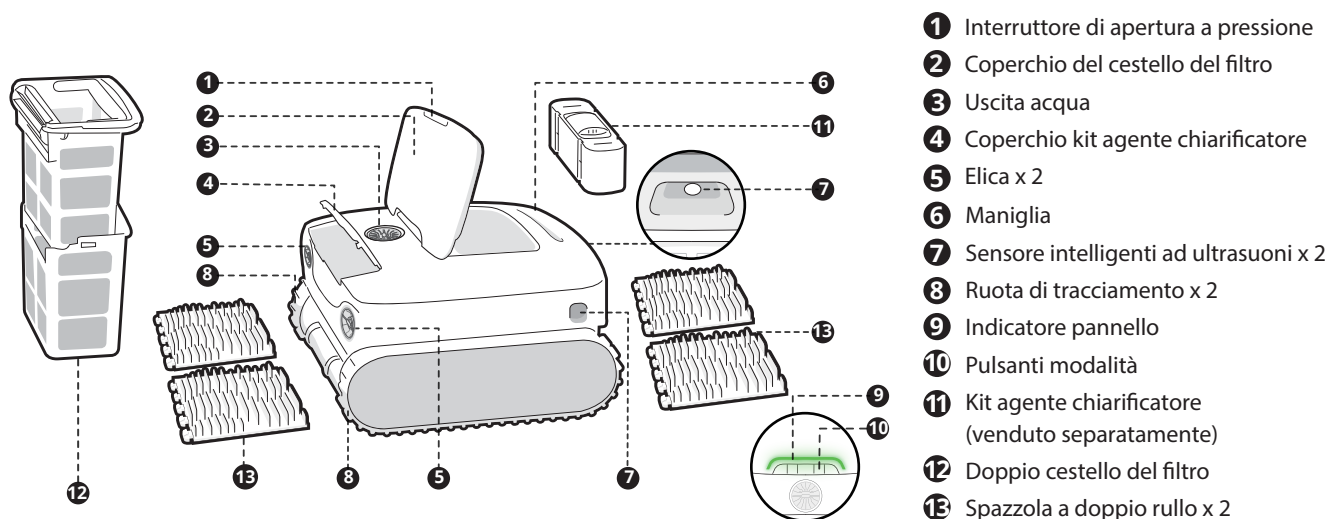

## Pulsante robot

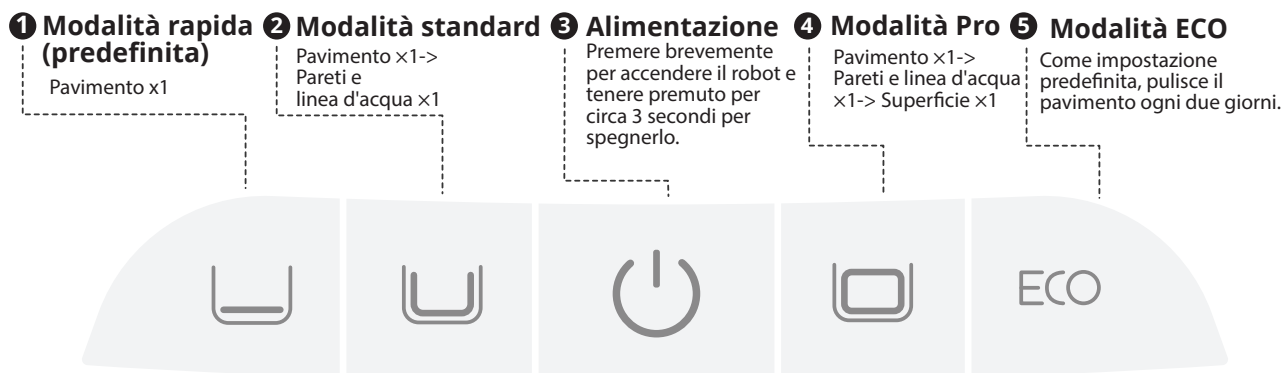

### • Configurazione hotspot

Tenere premuti entrambi i pulsanti "Alimentazione"+" ( ) Mod<sup>3</sup> a rapida" ( ) per circa 3<sup>1</sup> secondi per attivare la configurazione dell'hotspot.

### • Ripristino delle impostazioni di fabbrica

Tenere premuto il pulsante "Modalità Standard" ( ) + "Alimentazione" ( ) + "Modalità Pro" ( ) per circa 10<sup>4</sup> secondi per ripristinare le impostazioni di fabbrica.

## APP

### Scaricare la APP

È possibile scansionare il codice QR qui sotto oppure cercare "Beatbot" nell'App Store o in Google Play per scaricare l'APP.



### Collegamento del robot

Controllare le voci seguenti prima di connettersi:

- Assicurarsi che il robot sia acceso;
- Confermare che il cellulare e il robot si trovino nella stessa area di copertura del Wi-Fi e che il segnale sia potente;
- Assicurarsi che il proprio telefono sia collegato al Wi-Fi, che supporta solo la rete 2.4 GHz;
- Avvicinare il telefono al robot (la distanza tra il telefono e il robot deve essere al massimo di 1 m).

Dopo l'accensione, premere contemporaneamente i pulsanti "Alimentazione" e "Modalità rapida" per circa 3 secondi, si vedrà la spia lampeggiare di blu, il robot è quindi pronto per la configurazione della rete. Allora, scegli uno dei seguenti metodi per completare la connessione:

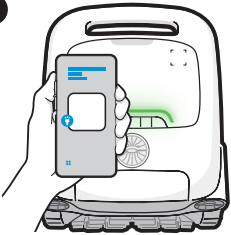
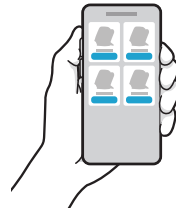
<p><b>A</b></p> 	<p><b>Scansiona per aggiungere:</b> Toccare "Scansiona per aggiungere" sulla home page dell'App, puntare la fotocamera sul codice QR del robot e seguire le istruzioni dell'App per completare la connessione.</p>	<p><b>B</b></p> 	<p><b>Aggiungi manualmente:</b> Toccare "Aggiungi dispositivo" nella home page dell'App, scegliere il modello di robot e seguire le istruzioni dell'App per completare la connessione.</p>
---	--	--	--

## Funzionamento del prodotto

### Wird geladen

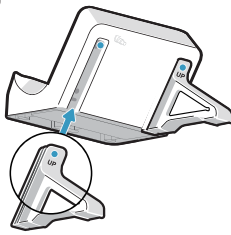
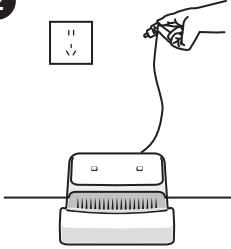
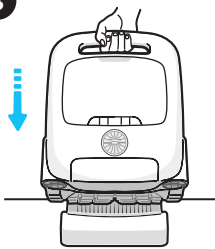
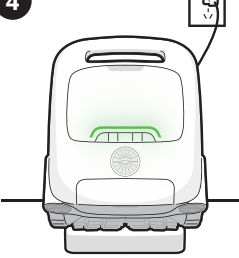
<p><b>1</b></p> 	<p><b>2</b></p> 	<p><b>3</b></p> 	<p><b>4</b></p> 
<p>Installare il dock di ricarica</p>	<p>Collegare la spina alla fonte di alimentazione</p>	<p>Posizionare il robot</p>	<p>Carica</p>

### Prima della pulizia

**!** Prima di metterlo in acqua, è essenziale collocare il robot su una superficie piana e attendere circa 5 secondi perché si calibri. Seguendo questi passaggi, si garantisce la massima efficacia del percorso di pulizia del robot. Il robot pulitore per piscina si scollega automaticamente dal telefono dopo essere entrato in acqua.

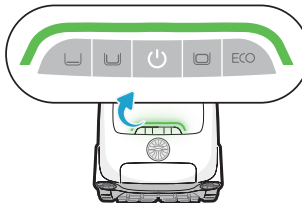
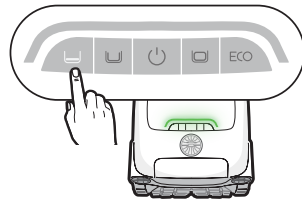
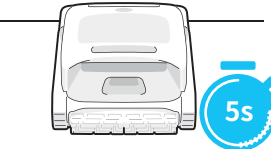
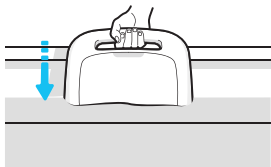
<p><b>1</b></p> 	<p><b>2</b></p> 	<p><b>3</b></p> 	<p><b>4</b></p> 
<p>Assicurarsi che il robot disponga di una carica sufficiente (l'indicatore ha una luce verde fissa).</p>	<p>Impostare la modalità di pulizia e il pulsante della modalità selezionata mostrerà una bianca fissa.</p>	<p>Collocare il robot su una superficie piana e attendere circa 5 secondi perché si calibri.</p>	<p>Posizionare il robot nell'acqua per avviare la pulizia automatica.</p>

Al termine dell'operazione di pulizia, il robot si aggancia automaticamente alla superficie accanto alla parete. Ma se il robot viene estratto con un gancio durante la pulizia, non avrà il tempo sufficiente per svuotarsi e il robot non riemergerà. Continuare a lasciare svuotare il robot per 2-3 minuti.

### Suggerimenti

 Se è la prima volta che usi la piscina in questa stagione, ti consigliamo di pulirla prima manualmente rimuovendo eventuali detriti di grandi dimensioni. Successivamente, puoi utilizzare il robot pulitore per piscine per mantenere la pulizia. Questo perché se ci sono molti detriti rimasti nella piscina durante la bassa stagione, l'uso del robot causerà l'intasamento del cestello del filtro più rapidamente e richiederà una pulizia più frequente. Pertanto, è più conveniente iniziare con la pulizia manuale.

 Ogni macchina viene sottoposta a test approfonditi, anche subacquei, prima di lasciare la fabbrica. Di conseguenza, potrebbero esserci alcune macchie d'acqua residua, il che è normale. Sentitevi liberi di usarlo.

## Productoverzicht

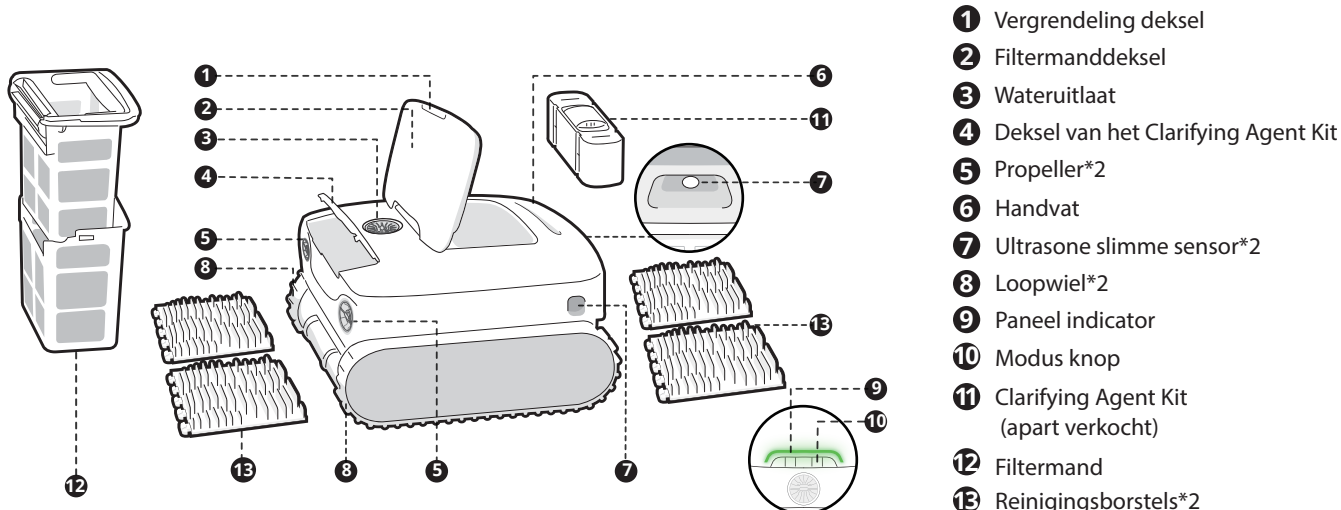

## Robot knop

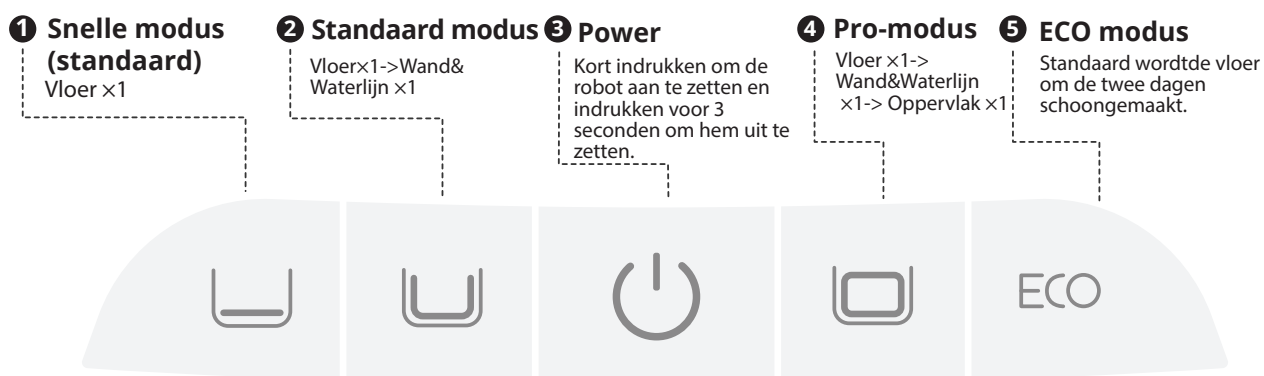

### • Hotspotconfiguratie

Houd de "Aan/uit" + (3) "Snelle modus" (1) knoppen voor ongeveer 3 seconden ingedrukt om de hotspotconfiguratie te activeren

### • Fabrieksinstellingen herstellen

Houd de "Standaard modus" (2) + "Aan/uit" (3) + "Pro-modus" (4) knoppen voor ongeveer 10 seconden tegelijkertijd ingedrukt om de fabrieksinstellingen te herstellen

## APP

### APP Downloaden

U kunt de QR-code hiernaast scannen of zoeken naar 'Beatbot' in de App Store of Google Play om de APP te downloaden.



### Robot verbinding

Controleer de volgende punten voordat u verbinding maakt:

- Zorg ervoor dat de robot is ingeschakeld;
- Bevestig dat zowel uw mobiele telefoon als de robot binnen hetzelfde Wi-Fi netwerk met een sterk signaal bevinden;
- Houd de telefoon dicht bij de robot (binnen 1 meter afstand);
- Zorg ervoor dat uw telefoon is verbonden met Wi-Fi en alleen het 2,4GHz-netwerk ondersteunt.

Na het inschakelen, drukt u tegelijkertijd op de knoppen 'Aan/uit' en 'Snelle modus' gedurende ongeveer 3 seconden. Wanneer u ziet dat de indicator blauw knippert, is de robot klaar voor de netwerkconfiguratie. Kies vervolgens een van de volgende methoden om de verbinding te voltooien:

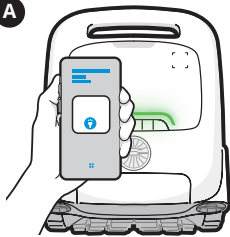
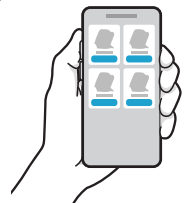
<p><b>A</b></p>  <p><b>Scannen om toe te voegen:</b></p> <p>Tik op "Scannen om toe te voegen" op de startpagina van de App, richt de camera op de QR-code op de robot en volg de instructies in de App om de verbinding te voltooien.</p>	<p>OF</p>	<p><b>B</b></p>  <p><b>Handmatig toevoegen:</b></p> <p>Tik op "Apparaat toevoegen" op de startpagina van de App, kies uw robotmodel en volg de instructies in de App om de verbinding te voltooien.</p>
--	-----------	---

## Vorbereiding voor gebruik

### Opladen

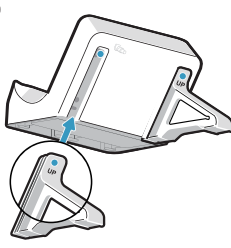
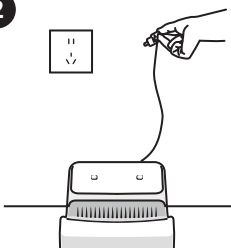
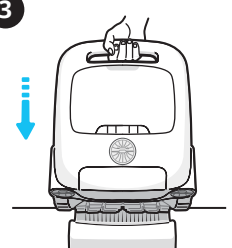
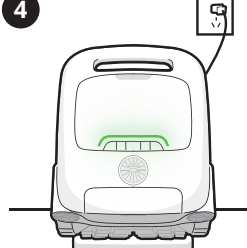
<p><b>1</b></p> 	<p><b>2</b></p> 	<p><b>3</b></p> 	<p><b>4</b></p> 
Installeer het laadstation	Sluit aan op de stroomvoorziening	Plaats de robot	Opladen

### Voor het schoonmaken

**!** Voordat de robot in het water gaat, is het belangrijk om deze op een vlakke ondergrond te plaatsen en ongeveer 5 seconden te wachten zodat hij kan kalibreren. Door deze stappen te volgen, maximaliseert u de effectiviteit van het schoonmaakpad van de robot. De robotzwembadreiniger zal automatisch de verbinding met de telefoon verbreken nadat hij in het water is gegaan.

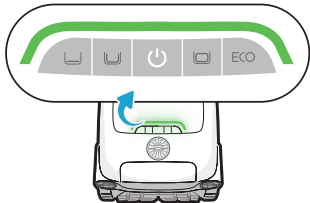
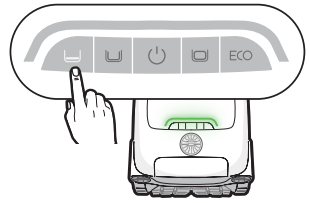
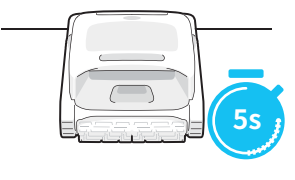
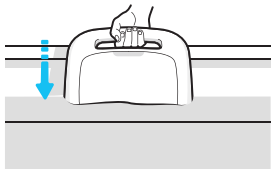
<p><b>1</b></p>  <p>Zorg ervoor dat de robot voldoende stroom heeft (de indicator geeft een continu groen licht aan).</p>	<p><b>2</b></p>  <p>Stel de schoonmaakmodus in en de geselecteerde modusknop zal constant wit oplichten.</p>	<p><b>3</b></p>  <p>Plaats de robot op een vlakke ondergrond en wacht ongeveer 5 seconden totdat hij is gekalibreerd.</p>	<p><b>4</b></p>  <p>Plaats de robot in het water om automatisch te beginnen met schoonmaken.</p>
--	---	---	---

Na het voltooien van de reinigingstaak zal de robot automatisch aanmeren aan de oppervlakte naast de muur. Als de robot tijdens het schoonmaken met een haak uit het water wordt gehaald en niet voldoende tijd heeft om water af te voeren, kan het zijn dat hij niet automatisch naar de oppervlakte komt. Laat de robot in dat geval 2-3 minuten leeglopen.

#### Tips



Als dit de eerste keer is dat u het zwembad dit seizoen gebruikt, raden we aan om het eerst handmatig schoon te maken door eventueel groot vuil te verwijderen. Daarna kunt u de robotzwembadreiniger gebruiken om de netheid te behouden. Dit komt omdat als er tijdens het laagseizoen veel vuil in het zwembad is achtergebleven, het gebruik van de robot ervoor zal zorgen dat het filtermandje sneller verstopt raakt en vaker moet worden schoongemaakt. Daarom is het handiger om met handmatige reiniging te beginnen.



Elke machine ondergaat grondige tests, waaronder onderwatertests, voordat deze de fabriek verlaat. Als gevolg hiervan kunnen er enkele resterende waterplekken zijn, wat normaal is. U kunt het apparaat gerust gebruiken.

# Beatbot



Scan to Check E-Manual

## Reach out to us is easy!

✉ [service@beatbot.com](mailto:service@beatbot.com)

🌐 [www.beatbot.com](http://www.beatbot.com)

☎ For North America: (833) 702-4399  
Mon-Sun 9:00 am-6:00 pm (CST)